

MITCHELL WAITE
Signature Series

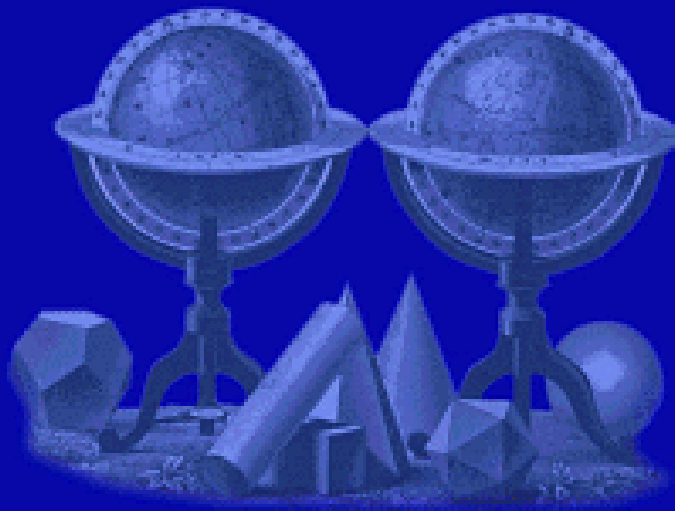

Developed by
MITCHELL WAITE

DATA STRUCTURES AND ALGORITHMS IN JAVA

SAMS



Data Structures & Algorithms in Java

by Robert Lafore

ISBN: 1571690956

[Sams](#) © 1998, 617 pages

Beautifully written and illustrated, this book introduces you to manipulating data in practical ways using Java examples.

▼ [Table of Contents](#)

▼ [Back Cover](#)

Synopsis by [Rebecca Rohan](#)

Once you've learned to program, you run into real-world problems that require more than a programming language alone to solve. *Data Structures and Algorithms in Java* is a gentle immersion into the most practical ways to make data do what you want it to do. Lafore's relaxed mastery of the techniques comes through as though he's chatting with the reader over lunch, gesturing toward appealing graphics. The book starts at the very beginning with data structures and algorithms, but assumes the reader understands a language such as Java or C++. Examples are given in Java to keep them free of explicit pointers.

Table of Contents

[Data Structures and Algorithms in Java](#) - 4

[Introduction](#) - 7

Part I

[Chapter 1](#) - Overview - 11

[Chapter 2](#) - Arrays - 29

[Chapter 3](#) - Simple Sorting - 63

Part II

[Chapter 4](#) - Stacks and Queues - 80

[Chapter 5](#) - Linked Lists - 142

[Chapter 6](#) - Recursion - 200

Part III

[Chapter 7](#) - Advanced Sorting - 243

[Chapter 8](#) - Binary Trees - 280

[Chapter 9](#) - Red-Black Trees - 311

Part IV

[Chapter 10](#) - 2-3-4 Trees and External Storage - 335

[Chapter 11](#) - Hash Tables - 372

[Chapter 12](#) - Heaps - 416

Part V

[Chapter 13](#) - Graphs - 438

[Chapter 14](#) - Weighted Graphs - 476

[Chapter 15](#) - When to Use What - 510

Part VI **Appendices**

[Appendix A](#) - How to Run the Workshop Applets and Example Programs - 521

[Appendix B](#) - Further Reading - 524

Back Cover

- Data Structures and Algorithms in Java, by Robert Lafore (The Waite Group, 1998) "A beautifully written and illustrated introduction to manipulating data in practical ways, using Java examples."
- Designed to be the most easily understood book ever written on data structures and algorithms
- Data Structures and Algorithms is taught with "Workshop Applets+ - animated Java programs that introduce complex topics in an intuitively obvious way
- The text is clear, straightforward, non-academic, and supported by numerous figures
- Simple programming examples are written in Java, which is easier to understand than C++

About the Author

Robert Lafore has degrees in Electrical Engineering and Mathematics, has worked as a systems analyst for the Lawrence Berkeley Laboratory, founded his own software company, and is a best-selling writer in the field of computer programming. Some of his current titles are *C++ Interactive Course*, *Object-*

Oriented Programming in C++, and *C Programming Using Turbo C++*. Earlier best-selling titles include *Assembly Language Primer for the IBM PC and XT* and (back at the beginning of the computer revolution) *Soul of CP/M*.

Data Structures and Algorithms in Java

Mitchell Waite

PUBLISHER: Mitchell Waite

ASSOCIATE PUBLISHER: Charles Drucker

EXECUTIVE EDITOR: Susan Walton

ACQUISITIONS EDITOR: Susan Walton

PROJECT DEVELOPMENT EDITOR: Kurt Stephan

CONTENT EDITOR: Harry Henderson

TECHNICAL EDITOR: Richard S. Wright, Jr.

CONTENT/TECHNICAL REVIEW: Jaime Niño, PhD, University of New Orleans

COPY EDITORS: Jim Bowie, Tonya Simpson

MANAGING EDITOR: Jodi Jensen

INDEXING MANAGER: Johnna L. VanHoose

EDITORIAL ASSISTANTS: Carmela Carvajal, Rhonda Tinch-Mize

SOFTWARE SPECIALIST: Dan Scherf

DIRECTOR OF BRAND MANAGEMENT: Alan Bower

PRODUCTION MANAGER: Cecile Kaufman

PRODUCTION TEAM SUPERVISOR: Brad Chinn

COVER DESIGNER: Sandra Schroeder

BOOK DESIGNER: Jean Bisesi

PRODUCTION: Mike Henry, Linda Knose, Tim Osborn, Staci Somers, Mark Walchle

© 1998 by The Waite Group, Inc.®

Published by Waite Group Press™

200 Tamal Plaza, Corte Madera, CA 94925

Waite Group Press™ is a division of Macmillan Computer Publishing.

All rights reserved. No part of this manual shall be reproduced, stored in a retrieval system, or transmitted by any means, electronic, mechanical, photocopying, desktop publishing, recording, or otherwise, without permission from the publisher. No patent liability is assumed with respect to the use of the information contained herein. While every precaution has been taken in the preparation of this book, the publisher and author assume no responsibility for errors or omissions. Neither is any liability assumed for damages resulting from the use of the information contained herein.

All terms mentioned in this book that are known to be registered trademarks, trademarks, or service marks are listed below. In addition, terms suspected of being trademarks, registered trademarks, or service marks have been appropriately capitalized. Waite Group Press cannot attest to the accuracy of this information. Use of a term in this book should not be regarded as affecting the validity of any registered trademark, trademark, or service mark.

The Waite Group is a registered trademark of The Waite Group, Inc.

Waite Group Press and The Waite Group logo are trademarks of The Waite Group, Inc. Sun's Java Workshop, and JDK is copyrighted (1998) by Sun Microsystems, Inc. Sun, Sun Microsystems, the Sun logo, Java, Java Workshop, JDK, the Java logo, and Duke are trademarks or registered trademarks of Sun Microsystems, Inc., in the United States and other countries. Netscape Navigator is a trademark of Netscape Communications Corporation. All Microsoft products mentioned are trademarks or registered trademarks of Microsoft Corporation.

All other product names are trademarks, registered trademarks, or service marks of their respective owners.

Printed in the United States of America

98 99 00 10 9 8 7 6 5 4 3 2 1

Library of Congress Cataloging-in-Publication Data

International Standard Book Number: 1-57169-095-6

Dedication

This book is dedicated to my readers, who have rewarded me over the years not only by buying my books, but with helpful suggestions and kind words. Thanks to you all.

About the Author

Robert Lafore has degrees in Electrical Engineering and Mathematics, has worked as a systems analyst for the Lawrence Berkeley Laboratory, founded his own software company, and is a best-selling writer in the field of computer programming. Some of his

current titles are *C++ Interactive Course*, *Object-Oriented Programming in C++*, and *C Programming Using Turbo C++*. Earlier best-selling titles include *Assembly Language Primer for the IBM PC and XT* and (back at the beginning of the computer revolution) *Soul of CP/M*.

Acknowledgments

My gratitude for the following people (and many others) cannot be fully expressed in this short acknowledgment. As always, Mitch Waite had the Java thing figured out before anyone else. He also let me bounce the applets off him until they did the job and extracted the overall form of the project from a miasma of speculation. My editor, Kurt Stephan, found great reviewers, made sure everyone was on the same page, kept the ball rolling, and gently but firmly ensured that I did what I was supposed to do. Harry Henderson provided a skilled appraisal of the first draft, along with many valuable suggestions. Richard S. Wright, Jr., as technical editor, corrected numerous problems with his keen eye for detail. Jaime Niño, Ph.D., of the University of New Orleans, attempted to save me from myself and occasionally succeeded, but should bear no responsibility for my approach or coding details. Susan Walton has been a staunch and much-appreciated supporter in helping to convey the essence of the project to the nontechnical. Carmela Carvajal was invaluable in extending our contacts with the academic world. Dan Scherf not only put the CD-ROM together, but was tireless in keeping me up-to-date on rapidly evolving software changes. Finally, Cecile Kaufman ably shepherded the book through its transition from the editing to the production process.

Acclaim for Robert Lafore's

"Robert has truly broken new ground with this book. Nowhere else have I seen these topics covered in such a clear and easy-to-understand, yet complete, manner. This book is sure to be an indispensable resource and reference to any programmer seeking to advance his or her skills and value beyond the mundane world of data entry screens and Windows dialog boxes.

I am especially impressed with the Workshop applets. Some 70 percent of your brain is designed for processing visual data. By interactively 'showing' how these algorithms work, he has really managed to find a way that almost anyone can use to approach this subject. He has raised the bar on this type of book forever."

—Richard S. Wright, Jr.

Author, *OpenGL SuperBible*

"Robert Lafore's explanations are always clear, accessible, and practical. His Java program examples reinforce learning with a visual demonstration of each concept. You will be able to understand and use every technique right away."

—Harry Henderson

Author, *The Internet and the Information Superhighway* and *Internet How-To*

"I found the tone of the presentation inviting and the use of applets for this topic a major plus."

—Jaime Niño, PhD

Associate Professor, Computer Science Department,

University of New Orleans

Introduction

This introduction tells you briefly

- What this book is about
- Why it's different
- Who might want to read it
- What you need to know before you read it
- The software and equipment you need to use it
- How this book is organized

What This Book Is About

This book is about data structures and algorithms as used in computer programming. Data structures are ways in which data is arranged in your computer's memory (or stored on disk). Algorithms are the procedures a software program uses to manipulate the data in these structures.

Almost every computer program, even a simple one, uses data structures and algorithms. For example, consider a program that prints address labels. The program might use an array containing the addresses to be printed, and a simple `for` loop to step through the array, printing each address.

The array in this example is a data structure, and the `for` loop, used for sequential access to the array, executes a simple algorithm. For uncomplicated programs with small amounts of data, such a simple approach might be all you need. However, for programs that handle even moderately large amounts of data, or that solve problems that are slightly out of the ordinary, more sophisticated techniques are necessary. Simply knowing the syntax of a computer language such as Java or C++ isn't enough.

This book is about what you need to know *after* you've learned a programming language. The material we cover here is typically taught in colleges and universities as a second-year course in computer science, after a student has mastered the fundamentals of programming.

What's Different About This Book

There are dozens of books on data structures and algorithms. What's different about this one? Three things:

- Our primary goal in writing this book is to make the topics we cover easy to understand.
- Demonstration programs called *Workshop applets* bring to life the topics we cover, showing you step by step, with "moving pictures," how data structures and algorithms work.
- The example code is written in Java, which is easier to understand than C, C++, or Pascal, the languages traditionally used to demonstrate computer science topics.

Let's look at these features in more detail.

Easy to Understand

Typical computer science textbooks are full of theory, mathematical formulas, and abstruse examples of computer code. This book, on the other hand, concentrates on simple explanations of techniques that can be applied to real-world problems. We avoid complex proofs and heavy math. There are lots of figures to augment the text.

Many books on data structures and algorithms include considerable material on software engineering. Software engineering is a body of study concerned with designing and implementing large and complex software projects.

However, it's our belief that data structures and algorithms are complicated enough without involving this additional discipline, so we have deliberately de-emphasized software engineering in this book. (We'll discuss the relationship of data structures and algorithms to software engineering in [Chapter 1, "Overview."](#))

Of course we do use an object-oriented approach, and we discuss various aspects of object-oriented design as we go along, including a mini-tutorial on OOP in [Chapter 1](#). Our primary emphasis, however, is on the data structures and algorithms themselves.

Workshop Applets

The CD-ROM that accompanies this book includes demonstration programs, in the form of Java applets, that cover the topics we discuss. These applets, which we call *Workshop applets*, will run on many computer systems, appletviewers, and Web browsers. (See the `readme` file on the CD-ROM for more details on compatibility.) The Workshop applets create graphic images that show you in "slow motion" how an algorithm works.

For example, in one Workshop applet, each time you push a button, a bar chart shows you one step in the process of sorting the bars into ascending order. The values of variables used in the sorting algorithm are also shown, so you can see exactly how the computer code works when executing the algorithm. Text displayed in the picture explains what's happening.

Another applet models a binary tree. Arrows move up and down the tree, so you can follow the steps involved in inserting or deleting a node from the tree. There are more than 20 Workshop applets—at least one for every major topic in the book.

These Workshop applets make it far more obvious what a data structure really looks like, or what an algorithm is supposed to do, than a text description ever could. Of course, we provide a text description as well. The combination of Workshop applets, clear text, and illustrations should make things easy.

These Workshop applets are standalone graphics-based programs. You can use them as a learning tool that augments the material in the book. (Note that they're not the same as the example code found in the text of the book, which we'll discuss next.)

Java Example Code

The Java language is easier to understand (and write) than languages such as C and C++. The biggest reason for this is that Java doesn't use pointers. Although it surprises some people, pointers aren't necessary for the creation of complex data structures and algorithms. In fact, eliminating pointers makes such code not only easier to write and to understand, but more secure and less prone to errors as well.

Java is a modern object-oriented language, which means we can use an object-oriented approach for the programming examples. This is important, because object-oriented programming (OOP) offers compelling advantages over the old-fashioned procedural

approach, and is quickly supplanting it for serious program development. Don't be alarmed if you aren't familiar with OOP. It's not that hard to understand, especially in a pointer-free environment such as Java. We'll explain the basics of OOP in [Chapter 1](#).

Who This Book Is For

This book can be used as a text in a data structures and algorithms course, typically taught in the second year of a computer science curriculum. However, it is also designed for professional programmers and for anyone else who needs to take the next step up from merely knowing a programming language. Because it's easy to understand, it is also appropriate as a supplemental text to a more formal course.

Who This Book Is For

This book can be used as a text in a data structures and algorithms course, typically taught in the second year of a computer science curriculum. However, it is also designed for professional programmers and for anyone else who needs to take the next step up from merely knowing a programming language. Because it's easy to understand, it is also appropriate as a supplemental text to a more formal course.

The Software You Need to Use this Book

All the software you need to use this book is included on the accompanying CD-ROM.

To run the Workshop applets you need a Web browser or an appletviewer utility such as the one in the Sun Microsystems Java Development Kit (JDK). Both a browser and the JDK are included on the CD-ROM. To compile and run the example programs you'll need the JDK. Microsoft Windows and various other platforms are supported. See the `readme` file on the included CD-ROM for details on supported platforms and equipment requirements.

How This Book Is Organized

This section is intended for teachers and others who want a quick overview of the contents of the book. It assumes you're already familiar with the topics and terms involved in a study of data structures and algorithms. (If you can't wait to get started with the Workshop applets, read [Appendix A, "How to Run the Workshop Applets and Example Programs,"](#) and the `readme` file on the CD-ROM first.)

The first two chapters are intended to ease the reader into data structures and algorithms as painlessly as possible.

[Chapter 1, "Overview,"](#) presents an overview of the topics to be discussed and introduces a small number of terms that will be needed later on. For readers unfamiliar with object-oriented programming, it summarizes those aspects of this discipline that will be needed in the balance of the book, and for programmers who know C++ but not Java, the key differences between these languages are reviewed.

[Chapter 2, "Arrays,"](#) focuses on arrays. However, there are two subtopics: the use of classes to encapsulate data storage structures and the class interface. Searching, insertion, and deletion in arrays and ordered arrays are covered. Linear searching and binary searching are explained. Workshop applets demonstrate these algorithms with unordered and ordered arrays.

In [Chapter 3, "Simple Sorting,"](#) we introduce three simple (but slow) sorting techniques: the bubble sort, selection sort, and insertion sort. Each is demonstrated by a Workshop applet.

[Chapter 4, "Stacks and Queues,"](#) covers three data structures that can be thought of as Abstract Data Types (ADTs): the stack, queue, and priority queue. These structures reappear later in the book, embedded in various algorithms. Each is demonstrated by a Workshop applet. The concept of ADTs is discussed.

[Chapter 5, "Linked Lists,"](#) introduces linked lists, including doubly linked lists and double-ended lists. The use of references as "painless pointers" in Java is explained. A Workshop applet shows how insertion, searching, and deletion are carried out.

In [Chapter 6, "Recursion,"](#) we explore recursion, one of the few chapter topics that is not a data structure. Many examples of recursion are given, including the Towers of Hanoi puzzle and the mergesort, which are demonstrated by Workshop applets.

[Chapter 7, "Advanced Sorting,"](#) delves into some advanced sorting techniques: Shellsort and quicksort. Workshop applets demonstrate Shellsort, partitioning (the basis of quicksort), and two flavors of quicksort.

In [Chapter 8, "Binary Trees,"](#) we begin our exploration of trees. This chapter covers the simplest popular tree structure: unbalanced binary search trees. A Workshop applet demonstrates insertion, deletion, and traversal of such trees.

[Chapter 9, "Red-Black Trees,"](#) explains red-black trees, one of the most efficient balanced trees. The Workshop applet demonstrates the rotations and color switches necessary to balance the tree.

In [Chapter 10, "2-3-4 Trees and External Storage,"](#) we cover 2-3-4 trees as an example of multiway trees. A Workshop applet shows how they work. We also discuss the relationship of 2-3-4 trees to B-trees, which are useful in storing external (disk) files.

[Chapter 11, "Hash Tables,"](#) moves into a new field, hash tables. Workshop applets demonstrate several approaches: linear and quadratic probing, double hashing, and separate chaining. The hash-table approach to organizing external files is discussed.

In [Chapter 12, "Heaps,"](#) we discuss the heap, a specialized tree used as an efficient implementation of a priority queue.

[Chapters 13, "Graphs,"](#) and [14, "Weighted Graphs,"](#) deal with graphs, the first with unweighted graphs and simple searching algorithms, and the second with weighted graphs and more complex algorithms involving the minimum spanning trees and shortest paths.

In [Chapter 15, "When to Use What,"](#) we summarize the various data structures described in earlier chapters, with special attention to which structure is appropriate in a given situation.

[Appendix A, "How to Run the Workshop Applets and Example Programs,"](#) tells how to use the Java Development Kit (the JDK) from Sun Microsystems, which can be used to run the Workshop applets and the example programs. The `readme` file on the included CD-ROM has additional information on these topics.

[Appendix B, "Further Reading,"](#) describes some books appropriate for further reading on data structures and other related topics.

Enjoy Yourself!

We hope we've made the learning process as painless as possible. Ideally, it should even be fun. Let us know if you think we've succeeded in reaching this ideal, or if not, where you think improvements might be made.

Part I

Chapter List

[Chapter 1:](#) [Overview](#)

[Chapter 2:](#) [Arrays](#)

[Chapter 3:](#) [Simple Sorting](#)

Chapter 1: Overview

Overview

As you start this book, you may have some questions:

- What are data structures and algorithms?
- What good will it do me to know about them?
- Why can't I just use arrays and `for` loops to handle my data?
- When does it make sense to apply what I learn here?

This chapter attempts to answer these questions. We'll also introduce some terms you'll need to know, and generally set the stage for the more detailed chapters to follow.

Next, for those of you who haven't yet been exposed to an object-oriented language, we'll briefly explain enough about OOP to get you started. Finally, for C++ programmers who don't know Java, we'll point out some of the differences between these languages.

Chapter 1: Overview

Overview

As you start this book, you may have some questions:

- What are data structures and algorithms?
- What good will it do me to know about them?
- Why can't I just use arrays and `for` loops to handle my data?
- When does it make sense to apply what I learn here?

This chapter attempts to answer these questions. We'll also introduce some terms you'll need to know, and generally set the stage for the more detailed chapters to follow.

Next, for those of you who haven't yet been exposed to an object-oriented language, we'll briefly explain enough about OOP to get you started. Finally, for C++ programmers who don't know Java, we'll point out some of the differences between these languages.

Overview of Data Structures

Another way to look at data structures is to focus on their strengths and weaknesses. In this section we'll provide an overview, in the form of a table, of the major data storage structures we'll be discussing in this book. This is a bird's-eye view of a landscape that we'll be covering later at ground level, so don't be alarmed if it looks a bit mysterious. Table 1.1 shows the advantages and disadvantages of the various data structures described in this book.

Table 1.1: Characteristics of Data Structures

Data Structure	Advantages	Disadvantages
Array	Quick insertion, very fast access if index known	Slow search, slow deletion, fixed size.
Ordered array	Quicker search than unsorted array.	Slow insertion and deletion, fixed size.
Stack	Provides last-in, first-out access.	Slow access to other items.
Queue	Provides first-in, first-out access.	Slow access to other items.
Linked list	Quick insertion, quick deletion.	Slow search.
Binary tree	Quick search, insertion, deletion (if tree remains balanced).	Deletion algorithm is complex.
Red-black tree	Quick search, insertion, deletion. Tree always balanced.	Complex.
2-3-4 tree	Quick search, insertion, deletion. Tree always balanced. Similar trees good for disk storage.	Complex.
Hash table	Very fast access if key known. Fast insertion.	Slow deletion, access slow if key not known, inefficient memory usage.
Heap	Fast insertion, deletion,	Slow access to other items.access to largest item.
Graph	Models real-world situations.	Some algorithms are slow and complex.



(The data structures shown in this table, except the arrays, can be thought of as Abstract Data Types, or ADTs. We'll describe what this means in [Chapter 5, "Linked Lists."](#))

Overview of Algorithms

Many of the algorithms we'll discuss apply directly to specific data structures. For most data structures, you need to know how to

- Insert a new data item.
- Search for a specified item.
- Delete a specified item.

You may also need to know how to *iterate* through all the items in a data structure, visiting each one in turn so as to display it or perform some other action on it.

One important algorithm category is *sorting*. There are many ways to sort data, and we devote [Chapter 3, "Simple Sorting,"](#) and [Chapter 7, "Advanced Sorting,"](#) to these algorithms.

The concept of *recursion* is important in designing certain algorithms. Recursion involves a method (a function) calling itself. We'll look at recursion in [Chapter 6, "Recursion."](#)

Definitions

Let's look at a few of the terms that we'll be using throughout this book.

Database

We'll use the term *database* to refer to all the data that will be dealt with in a particular situation. We'll assume that each item in a database has a similar format. As an example, if you create an address book using the Cardfile program, all the cards you've created constitute a database. The term *file* is sometimes used in this sense, but because our database is often stored in the computer's memory rather than on a disk, this term can be misleading.

The term *database* can also refer to a large program consisting of many data structures and algorithms, which relate to each other in complex ways. However, we'll restrict our use of the term to the more modest definition.

Record

Records are the units into which a database is divided. They provide a format for storing information. In the Cardfile program, each card represents a record. A record includes all the information about some entity, in a situation in which there are many such entities. A record might correspond to a person in a personnel file, a car part in an auto supply inventory, or a recipe in a cookbook file.

Field

A record is usually divided into several *fields*. A field holds a particular kind of data. In the Cardfile program there are really only two fields: the index line (above the double line)

and the rest of the data (below the line), which both hold text. Generally, each field holds a particular kind of data. [Figure 1.1](#) shows the index line field as holding a person's name.

More sophisticated database programs use records with more fields than Cardfile has. Figure 1.2 shows such a record, where each line represents a distinct field.

In a Java program, records are usually represented by *objects* of an appropriate class. (In C, records would probably be represented by structures.) Individual variables within an object represent data fields. Fields within a class object are called *fields* in Java (but *members* in C and C++).

Key

To search for a record within a database you need to designate one of the record's fields as a *key*. You'll search for the record with a specific key. For example, in the Cardfile program you might search in the index-line field for the key "Brown." When you find the record with this key, you'll be able to access all its fields, not just the key. We might say that the key *unlocks* the entire record.

In Cardfile you can also search for individual words or phrases in the rest of the data on the card, but this is actually all one field. The program searches through the text in the entire field even if all you're looking for is the phone number. This kind of text search isn't very efficient, but it's flexible because the user doesn't need to decide how to divide the card into fields.

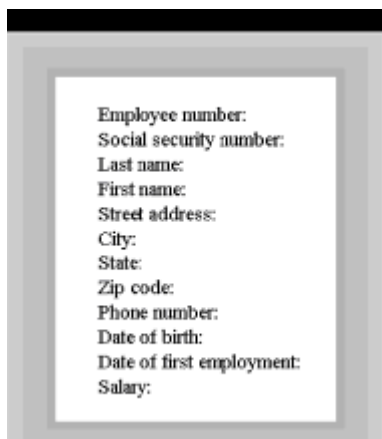

Figure 1.2: A record with multiple fields

In a more full-featured database program, you can usually designate any field as the key. In Figure 1.2, for example, you could search by zip code and the program would find all employees who live in that zip code.

Search Key

The key value you're looking for in a search is called the *search key*. The search key is compared with the key field of each record in turn. If there's a match, the record can be returned or displayed. If there's no match, the user can be informed of this fact.

Object-Oriented Programming

This section is for those of you who haven't been exposed to object-oriented programming. However, caveat emptor. We cannot, in a few pages, do justice to all the innovative new ideas associated with OOP. Our goal is merely to make it possible for you

to understand the example programs in the text. What we say here won't transform you into an object-oriented Java programmer, but it should make it possible for you to follow the example programs.

If after reading this section and examining some of the sample code in the following chapters you still find the whole OOP business as alien as quantum physics, then you may need a more thorough exposure to OOP. See the reading list in [Appendix B, "Further Reading,"](#) for suggestions.

Problems with Procedural Languages

OOP was invented because procedural languages, such as C, Pascal, and BASIC, were found to be inadequate for large and complex programs. Why was this?

The problems have to do with the overall organization of the program. Procedural programs are organized by dividing the code into functions (called procedures or subroutines in some languages). Groups of functions could form larger units called modules or files.

Crude Organizational Units

One difficulty with this kind of function-based organization was that it focused on functions at the expense of data. There weren't many options when it came to data. To simplify slightly, data could be local to a particular function or it could be global—accessible to all functions. There was no way (at least not a flexible way) to specify that some functions could access a variable and others couldn't.

This caused problems when several functions needed to access the same data. To be available to more than one function, such variables had to be global, but global data could be accessed inadvertently by any function in the program. This led to frequent programming errors. What was needed was a way to fine-tune data accessibility, allowing variables to be available to functions with a need to access it, but hiding it from others.

Poor Modeling of the Real World

It is also hard to conceptualize a real-world problem using procedural languages. Functions carry out a task, while data stores information, but most real-world objects do both these things. The thermostat on your furnace, for example, carries out tasks (turning the furnace on and off) but also stores information (the actual current temperature and the desired temperature).

If you wrote a thermostat control program, you might end up with two functions, `furnace_on()` and `furnace_off()`, but also two global variables, `currentTemp` (supplied by a thermometer) and `desiredTemp` (set by the user). However, these functions and variables wouldn't form any sort of programming unit; there would be no unit in the program you could call `thermostat`. The only such unit would be in the programmer's mind.

For large programs, which might contain hundreds of entities like thermostats, this procedural approach made things chaotic, error-prone, and sometimes impossible to implement at all.

Objects in a Nutshell

The idea of *objects* arose in the programming community as a solution to the problems with procedural languages.

Objects

Here's the amazing breakthrough that is the key to OOP: An object contains *both functions and variables*. A `thermostat` object, for example, would contain not only `furnace_on()` and `furnace_off()` functions, but also `currentTemp` and `desiredTemp`. Incidentally, before going further we should note that in Java, functions are called *methods* and variables are called *fields*.

This new entity, the object, solves several problems simultaneously. Not only does a programming object correspond more accurately to objects in the real world, it also solves the problem engendered by global data in the procedural model. The `furnace_on()` and `furnace_off()` methods can access `currentTemp` and `desiredTemp`. These variables are hidden from methods that are not part of `thermostat`, however, so they are less likely to be accidentally changed by a rogue method.

Classes

You might think that the idea of an object would be enough for one programming revolution, but there's more. Early on, it was realized that you might want to make several objects of the same type. Maybe you're writing a furnace control program for an entire apartment house, for example, and you need several dozen `thermostat` objects in your program. It seems a shame to go to the trouble of specifying each one separately. Thus, the idea of classes was born.

A *class* is a specification—a blueprint—for one or more objects. Here's how a `thermostat` class, for example, might look in Java:

```
class thermostat
{
    private float currentTemp();
    private float desiredTemp();

    public void furnace_on()
    {
        // method body goes here
    }

    public void furnace_off()
    {
        // method body goes here
    }
} // end class thermostat
```

The Java keyword `class` introduces the class specification, followed by the name you want to give the class; here it's `thermostat`. Enclosed in curly brackets are the fields and methods (variables and functions) that make up the class. We've left out the body of the methods; normally there would be many lines of program code for each one.

C programmers will recognize this syntax as similar to a structure, while C++ programmers will notice that it's very much like a class in C++, except that there's no semicolon at the end. (Why did we need the semicolon in C++ anyway?)

Creating Objects

Specifying a class doesn't create any objects of that class. (In the same way specifying a structure in C doesn't create any variables.) To actually create objects in Java you must use the keyword `new`. At the same time an object is created, you need to store a

reference to it in a variable of suitable type; that is, the same type as the class.

What's a reference? We'll discuss references in more detail later. In the meantime, think of it as a name for an object. (It's actually the object's address, but you don't need to know that.)

Here's how we would create two references to type `thermostat`, create two new `thermostat` objects, and store references to them in these variables:

```
thermostat therm1, therm2; // create two references

therm1 = new thermostat(); // create two objects and

therm2 = new thermostat(); // store references to them
```

Incidentally, creating an object is also called *instantiating* it, and an object is often referred to as an *instance* of a class.

Accessing Object Methods

Once you've specified a class and created some objects of that class, other parts of your program need to interact with these objects. How do they do that?

Typically, other parts of the program interact with an object's methods (functions), not with its data (fields). For example, to tell the `therm2` object to turn on the furnace, we would say

```
therm2.furnace_on();
```

The dot operator (`.`) associates an object with one of its methods (or occasionally with one of its fields).

At this point we've covered (rather telegraphically) several of the most important features of OOP. To summarize:

- Objects contain both methods (functions) and fields (data).
- A class is a specification for any number of objects.
- To create an object, you use the keyword `new` in conjunction with the class name.
- To invoke a method for a particular object you use the dot operator.

These concepts are deep and far-reaching. It's almost impossible to assimilate them the first time you see them, so don't worry if you feel a bit confused. As you see more classes and what they do, the mist should start to clear.

A Runnable Object-Oriented Program

Let's look at an object-oriented program that runs and generates actual output. It features a class called `BankAccount` that models a checking account at a bank. The program creates an account with an opening balance, displays the balance, makes a deposit and a withdrawal, and then displays the new balance. Here's the listing for `bank.java`:

```
// bank.java
```

```

// demonstrates basic OOP syntax

// to run this program: C>java BankApp

import java.io.*;                                // for I/O

////////////////////////////////////

class BankAccount

{
    private double balance;                        // account balance

    public BankAccount(double openingBalance) // constructor
    {
        balance = openingBalance;
    }

    public void deposit(double amount)           // makes deposit
    {
        balance = balance + amount;
    }

    public void withdraw(double amount)         // makes
withdrawal
    {
        balance = balance - amount;
    }

    public void display()                        // displays
balance
    {
        System.out.println("balance=" + balance);
    }
} // end class BankAccount

////////////////////////////////////

class BankApp
{
    public static void main(String[] args)
    {
        BankAccount bal = new BankAccount(100.00); // create acct

        System.out.print("Before transactions, ");
        bal.display();                               // display balance

        bal.deposit(74.35);                          // make deposit
        bal.withdraw(20.00);                          // make withdrawal

        System.out.print("After transactions, ");
        bal.display();                               // display balance
    } // end main()
} // end class BankApp

```

Here's the output from this program:

```
Before transactions, balance=100
```

```
After transactions, balance=154.35
```

There are two classes in `bank.java`. The first one, `BankAccount`, contains the fields and methods for our bank account. We'll examine it in detail in a moment. The second class, `BankApp`, plays a special role.

The BankApp Class

To execute the program from a DOS box, you type `java BankApp` following the C: prompt:

```
C:java BankApp
```

This tells the `java` interpreter to look in the `BankApp` class for the method called `main()`. Every Java application must have a `main()` method; execution of the program starts at the beginning of `main()`, as you can see in the `bank.java` listing. (You don't need to worry yet about the `String[] args` argument in `main()`.)

The `main()` method creates an object of class `BankAccount`, initialized to a value of 100.00, which is the opening balance, with this statement:

```
BankAccount bal = new BankAccount(100.00); // create acct
```

The `System.out.print()` method displays the string used as its argument, `Before transactions,`, and the account displays its balance with the following statement:

```
bal.display();
```

The program then makes a deposit to, and a withdrawal from, the account:

```
bal.deposit(74.35);  
bal.withdraw(20.00);
```

Finally, the program displays the new account balance and terminates.

The BankAccount Class

The only data field in the `BankAccount` class is the amount of money in the account, called `balance`. There are three methods. The `deposit()` method adds an amount to the balance, `withdrawal()` subtracts an amount, and `display()` displays the balance.

Constructors

The `BankAccount` class also features a constructor. A *constructor* is a special method that's called automatically whenever a new object is created. A constructor always has exactly the same name as the class, so this one is called `BankAccount()`. This constructor has one argument, which is used to set the opening balance when the account is created.

A constructor allows a new object to be initialized in a convenient way. Without the constructor in this program, you would have needed an additional call to `deposit()` to put the opening balance in the account.

Public and Private

Notice the keywords `public` and `private` in the `BankAccount` class. These keywords are *access modifiers* and determine what methods can access a method or field. The `balance` field is preceded by `private`. A field or method that is private can only be accessed by methods that are part of the same class. Thus, `balance` cannot be accessed by statements in `main()`, because `main()` is not a method in `BankAccount`.

However, all the methods in `BankAccount` have the access modifier `public`, so they can be accessed by methods in other classes. That's why statements in `main()` can call `deposit()`, `withdrawal()`, and `display()`.

Data fields in a class are typically made private and methods are made public. This protects the data; it can't be accidentally modified by methods of other classes. Any outside entity that needs to access data in a class must do so using a method of the same class. Data is like a queen bee, kept hidden in the middle of the hive, fed and cared for by worker-bee methods.

Inheritance and Polymorphism

We'll briefly mention two other key features of object-oriented programming: inheritance and polymorphism.

Inheritance is the creation of one class, called the *extended* or derived class, from another class called the *base* class. The extended class has all the features of the base class, plus some additional features. For example, a `secretary` class might be derived from a more general `employee` class, and include a field called `typingSpeed` that the `employee` class lacked.

In Java, inheritance is also called *subclassing*. The base class may be called the *superclass*, and the extended class may be called the *subclass*.

Inheritance makes it easy to add features to an existing class and is an important aid in the design of programs with many related classes. Inheritance thus makes it easy to reuse classes for a slightly different purpose, a key benefit of OOP.

Polymorphism involves treating objects of different classes in the same way. For polymorphism to work, these different classes must be derived from the same base class. In practice, polymorphism usually involves a method call that actually executes different methods for objects of different classes.

For example, a call to `display()` for a `secretary` object would invoke a `display` method in the `secretary` class, while the exact same call for a `manager` object would invoke a different `display` method in the `manager` class. Polymorphism simplifies and clarifies program design and coding.

For those not familiar with them, inheritance and polymorphism involve significant additional complexity. To keep the focus on data structures and algorithms, we have avoided these features in our example programs. Inheritance and polymorphism are important and powerful aspects of OOP but are not necessary for the explanation of data structures and algorithms.

Software Engineering

In recent years, it has become fashionable to begin a book on data structures and algorithms with a chapter on software engineering. We don't follow that approach, but let's briefly examine software engineering and see how it fits into the topics we discuss in this book.

Software engineering is the study of how to create large and complex computer programs, involving many programmers. It focuses on the overall design of the program and on the creation of that design from the needs of the end users. Software engineering is concerned with life cycle of a software project, which includes specification, design, verification, coding, testing, production, and maintenance.

It's not clear that mixing software engineering on one hand, and data structures and algorithms on the other, actually helps the student understand either topic. Software engineering is rather abstract and is difficult to grasp until you've been involved yourself in a large project. Data structures and algorithms, on the other hand, is a nuts-and-bolts discipline concerned with the details of coding and data storage.

Accordingly we focus on the nuts-and-bolts aspects of data structures and algorithms. How do they really work? What structure or algorithm is best in a particular situation? What do they look like translated into Java code? As we noted, our intent is to make the material as easy to understand as possible. For further reading, we mention some books on software engineering in [Appendix B](#).

Java for C++ Programmers

If you're a C++ programmer who has not yet encountered Java, you might want to read this section. We'll mention several ways in which Java differs from C++.

This section is not intended to be a primer on Java. We don't even cover all the differences between C++ and Java. We're only interested in a few Java features that might make it hard for C++ programmers to figure out what's going on in the example programs.

No Pointers

The biggest difference between C++ and Java is that Java doesn't use pointers. To a C++ programmer this may at first seem quite amazing. How can you get along without pointers?

Throughout this book we'll be using pointer-free code to build complex data structures. You'll see that it's not only possible, but actually easier than using C++ pointers.

Actually Java only does away with *explicit* pointers. Pointers, in the form of memory addresses, are still there, under the surface. It's sometimes said that in Java, *everything* is a pointer. This is not completely true, but it's close. Let's look at the details.

References

Java treats primitive data types (such as `int`, `float`, and `double`) differently than objects. Look at these two statements:

```
int intVar;           // an int variable called intVar
BankAccount bc1;     // reference to a BankAccount object
```

In the first statement, a memory location called `intVar` actually holds a numerical value such as 127 (assuming such a value has been placed there). However, the memory location `bc1` does not hold the data of a `BankAccount` object. Instead, it contains the *address* of a `BankAccount` object that is actually stored elsewhere in memory. The

name `bc1` is a *reference* to this object; it's not the object itself.

Actually, `bc1` won't hold a reference if it has not been assigned an object at some prior point in the program. Before being assigned an object, it holds a reference to a special object called `null`. In the same way, `intVar` won't hold a numerical value if it's never been assigned one. The compiler will complain if you try to use a variable that has never been assigned a value.

In C++, the statement

```
BankAccount bc1;
```

actually creates an object; it sets aside enough memory to hold all the object's data. In Java, all this statement creates is a place to put an object's memory address. You can think of a reference as a pointer with the syntax of an ordinary variable. (C++ has reference variables, but they must be explicitly specified with the `&` symbol.)

Assignment

It follows that the assignment operator (`=`) operates differently with Java objects than with C++ objects. In C++, the statement

```
bc2 = bc1;
```

copies all the data from an object called `bc1` into a different object called `bc2`. Following this statement are two objects with the same data. In Java, on the other hand, this same assignment statement copies the memory address that `bc1` refers to into `bc2`. Both `bc1` and `bc2` now refer to exactly the same object; they are references to it.

This can get you into trouble if you're not clear on what the assignment operator does. Following the assignment statement shown above, the statement

```
bc1.withdraw(21.00);
```

and the statement

```
bc2.withdraw(21.00);
```

both withdraw \$21 from the same bank account object.

Suppose you actually want to copy data from one object to another. In this case you must make sure you have two separate objects to begin with, and then copy each field separately. The equal sign won't do the job.

The `new` Operator

Any object in Java must be created using `new`. However, in Java, `new` returns a reference, not a pointer as in C++. Thus, pointers aren't necessary to use `new`. Here's one way to create an object:

```
BankAccount ba1;  
ba1 = new BankAccount();
```

Eliminating pointers makes for a more secure system. As a programmer, you can't find out the actual address of `ba1`, so you can't accidentally corrupt it. However, you probably don't need to know it unless you're planning something wicked.

How do you release memory that you've acquired from the system with `new` and no longer need? In C++, you use `delete`. In Java, you don't need to worry about it. Java periodically looks through each block of memory that was obtained with `new` to see if valid references to it still exist. If there are no such references, the block is returned to the free memory store. This is called *garbage collection*.

In C++ almost every programmer at one time or another forgets to delete memory blocks, causing "memory leaks" that consume system resources, leading to bad performance and even crashing the system. Memory leaks can't happen in Java (or at least hardly ever).

Arguments

In C++, pointers are often used to pass objects to functions to avoid the overhead of copying a large object. In Java, objects are always passed as references. This also avoids copying the object.

```
void method1()
{
    BankAccount bal = new BankAccount(350.00);
    method2(bal);
}

void method2(BankAccount acct)
{
}
```

In this code, the references `bal` and `acct` both refer to the same object.

Primitive data types, on the other hand, are always passed by value. That is, a new variable is created in the function and the value of the argument is copied into it.

Equality and Identity

In Java, if you're talking about primitive types, the equality operator (`==`) will tell you whether two variables have the same value:

```
int intVar1 = 27;
int intVar2 = intVar1;
if(intVar1 == intVar2)
    System.out.println("They're equal");
```

This is the same as the syntax in C and C++, but in Java, because they use references, relational operators work differently with objects. The equality operator, when applied to objects, tells you whether two references are identical; that is, whether they refer to the same object:

```
carPart cp1 = new carPart("fender");
carPart cp2 = cp1;
if(cp1 == cp2)
    System.out.println("They're Identical");
```

In C++ this operator would tell you if two objects contained the same data. If you want to see whether two objects contain the same data in Java, you must use the `equals()` method of the `Object` class:

```

carPart cp1 = new carPart("fender");
carPart cp2 = cp1;
if( cp1.equals(cp2) )
    System.out.println("They're equal");

```

This works because all objects in Java are implicitly derived from the `Object` class.

Overloaded Operators

This is easy: there are no overloaded operators in Java. In C++, you can redefine `+`, `*`, `=`, and most other operators so they behave differently for objects of a particular class. No such redefinition is possible in Java. Instead, use a method such as `add()`.

Primitive Variable Types

The primitive or built-in variable types in Java are shown in Table 1.2.

Table 1.2: Primitive Data Types

Name	Size in Bits	Range of Values
boolean	1	true or false
byte	8	-128 to +127
char	16	'\u0000' to '\uFFFF'
short	16	-32,768 to +32,767
int	32	-2,147,483,648 to +2,147,483,647
long	64	-9,223,372,036,854,775,808 to +9,223,372,036,854,775,807
float	32	approximately 10^{-38} to 10^{+38} ; 7 significant digits
double	64	approximately 10^{-308} to 10^{+308} ; 15 significant digits

Unlike C and C++, which use integers for `true/false` values, `boolean` is a distinct type in Java.

Type `char` is unsigned and uses two bytes to accommodate the Unicode character representation scheme, which can handle international characters.

The `int` type varies in size in C and C++, depending on the specific computer platform; in Java an `int` is always 32 bits.

Literals of type `float` use the suffix `F` (for example, `3.14159F`); literals of type `double` need no suffix. Literals of type `long` use suffix `L` (as in `45L`); literals of the other integer types need no suffix.

Java is more strongly typed than C and C++; many conversions that were automatic in those languages require an explicit cast in Java.

All types not shown in Table 1.2, such as `String`, are classes.

Input/Output

For the console-mode applications we'll be using for example programs in this book, some clunky-looking but effective constructions are available for input and output. They're quite different from the workhorse `cout` and `cin` approach in C++ and `printf()` and `scanf()` in C.

All the input/output routines we show here require the line

```
import java.io.*;
```

at the beginning of your source file.

Output

You can send any primitive type (numbers and characters), and `String` objects as well, to the display with these statements:

```
System.out.print(var);    // displays var, no linefeed
System.out.println(var);  // displays var, then starts new line
```

The first statement leaves the cursor on the same line; the second statement moves it to the beginning of the next line.

Because output is buffered, you'll need to use a `println()` method as the last statement in a series to actually display everything. It causes the contents of the buffer to be transferred to the display:

```
System.out.print(var1);    // nothing appears
System.out.print(var2);    // nothing appears
System.out.println(var3);  // var1, var2, and var3 are all
displayed
```

You can also use `System.out.flush()` to cause the buffer to be displayed without going to a new line:

```
System.out.print("Enter your name: ");
System.out.flush();
```

Inputting a String

Input is considerably more involved than output. In general, you want to read any input as a `String` object. If you're actually inputting something else, such as a character or number, you then convert the `String` object to the desired type.

String input is fairly baroque. Here's how it looks:

```
public static String getString() throws IOException
{
    InputStreamReader isr = new InputStreamReader(System.in);
    BufferedReader br = new BufferedReader(isr);
    String s = br.readLine();
    return s;
}
```

This method returns a `String` object, which is composed of characters typed on the keyboard and terminated with the **Enter** key.

Besides importing `java.io.*`, you'll also need to add `throws IOException` to all input methods, as shown in the preceding code. The details of the `InputStreamReader` and `BufferedReader` classes need not concern us here. This approach was introduced with version 1.1.3 of Sun Microsystems' Java Development Kit (JDK).

Earlier versions of the JDK used the `System.in` object to read individual characters, which were then concatenated to form a `String` object. The termination of the input was signaled by a newline (`'\n'`) character, generated when the user pressed **Enter**.

Here's the code for this older approach:

```
public String getString() throws IOException
{
    String s = "";
    int ch;

    while( (ch=System.in.read()) != -1 && (char)ch != '\n' )
        s += (char)ch;
    return s;
}
```

Here characters are read as integers, which allows the negative value `-1` to signal an end-of-file (EOF). The `while` loop reads characters until an end-of-file or a newline occurs. You'll need to use this version of `getString()` if you're using older versions of the JDK.

Inputting a Character

Suppose you want your program's user to enter a character. (By *enter* we mean typing something and pressing the **Enter** key.) The user may enter a single character or (incorrectly) more than one. Therefore, the safest way to read a character involves reading a `String` and picking off its first character with the `charAt()` method:

```
public static char getChar() throws IOException
{
    String s = getString();
    return s.charAt(0);
}
```

The `charAt()` method of the `String` class returns a character at the specified position in the `String` object; here we get the first one. The approach shown avoids extraneous

characters being left in the input buffer. Such characters can cause problems with subsequent input.

Inputting Integers

To read numbers, you make a `String` object as shown before and convert it to the type you want using a conversion method. Here's a method, `getInt()`, that converts input into type `int` and returns it:

```
public int getInt() throws IOException
{
    String s = getString();
    return Integer.parseInt(s);
}
```

The `parseInt()` method of class `Integer` converts the string to type `int`. A similar routine, `parseLong()`, can be used to convert type `long`.

For simplicity, we don't show any error-checking in the input routines in the example programs. The user must type appropriate input or an exception will occur. With the code shown here the exception will cause the program to terminate. In a serious program you should analyze the input string before attempting to convert it, and also catch any exceptions and process them appropriately.

Inputting Floating-Point Numbers

Types `float` and `double` can be handled in somewhat the same way as integers, but the conversion process is more complex. Here's how you read a number of type `double`:

```
public int getDouble() throws IOException
{
    String s = getString();
    Double aDub = Double.valueOf(s);
    return aDub.doubleValue();
}
```

The `String` is first converted to an object of type `Double` (uppercase D), which is a "wrapper" class for type `double`. A method of `Double` called `doubleValue()` then converts the object to type `double`.

For type `float`, there's an equivalent `Float` class, which has equivalent `valueOf()` and `floatValue()` methods.

Java Library Data Structures

The Java `java.util` package contains data structures, such as `Vector` (an extensible array), `Stack`, `Dictionary`, and `Hashtable`. In this book we'll largely ignore these built-in classes. We're interested in teaching fundamentals, not in the details of a particular data-structure implementation.

However, such class libraries, whether those that come with Java or others available from third-party developers, can offer a rich source of versatile, debugged storage classes. This book should equip you with the knowledge you'll need to know what sort of data structure you need and the fundamentals of how it works. Then you can decide whether you should write your own classes or use pre-written library classes. If you use a class library, you'll know which classes you need and whether a particular implementation works in your

situation.

Summary

- A data structure is the organization of data in a computer's memory or in a disk file.
- The correct choice of data structure allows major improvements in program efficiency.
- Examples of data structures are arrays, stacks, and linked lists.
- An algorithm is a procedure for carrying out a particular task.
- In Java, an algorithm is usually implemented by a class method.
- Many of the data structures and algorithms described in this book are most often used to build databases.
- Some data structures are used as programmer's tools: they help execute an algorithm.
- Other data structures model real-world situations, such as telephone lines running between cities.
- A database is a unit of data storage comprising many similar records.
- A record often represents a real-world object, such as an employee or a car part.
- A record is divided into fields. Each field stores one characteristic of the object described by the record.
- A key is a field in a record that's used to carry out some operation on the data. For example, personnel records might be sorted by a `LastName` field.
- A database can be searched for all records whose key field has a certain value. This value is called a search key.

Summary

- A data structure is the organization of data in a computer's memory or in a disk file.
- The correct choice of data structure allows major improvements in program efficiency.
- Examples of data structures are arrays, stacks, and linked lists.
- An algorithm is a procedure for carrying out a particular task.
- In Java, an algorithm is usually implemented by a class method.
- Many of the data structures and algorithms described in this book are most often used to build databases.
- Some data structures are used as programmer's tools: they help execute an algorithm.
- Other data structures model real-world situations, such as telephone lines running between cities.

- A database is a unit of data storage comprising many similar records.
- A record often represents a real-world object, such as an employee or a car part.
- A record is divided into fields. Each field stores one characteristic of the object described by the record.
- A key is a field in a record that's used to carry out some operation on the data. For example, personnel records might be sorted by a `LastName` field.
- A database can be searched for all records whose key field has a certain value. This value is called a search key.

The Array Workshop Applet

Suppose that you're coaching a kids-league baseball team and you want to keep track of which players are present at the practice field. What you need is an attendance-monitoring program for your laptop; a program that maintains a database of the players who have shown up for practice. You can use a simple data structure to hold this data. There are several actions you would like to be able to perform:

- Insert a player into the data structure when the player arrives at the field.
- Check to see if a particular player is present by searching for his or her number in the structure.
- Delete a player from the data structure when the player goes home.

These three operations will be the fundamental ones in most of the data storage structures we'll study in this book.

In this book we'll often begin the discussion of a particular data structure by demonstrating it with a Workshop applet. This will give you a feeling for what the structure and its algorithms do, before we launch into a detailed discussion and demonstrate actual example code. The Workshop applet called Array shows how an array can be used to implement insertion, searching, and deletion. Start up this applet, as described in [Appendix A](#), with

```
C:appletviewer Array.html
```

Figure 2.1 shows what you'll see. There's an array with 20 elements, 10 of which have data items in them. You can think of these items as representing your baseball players. Imagine that each player has been issued a team shirt with the player's number on the back. To make things visually interesting, the shirts come in a wide variety of colors. You can see each player's number and shirt color in the array.

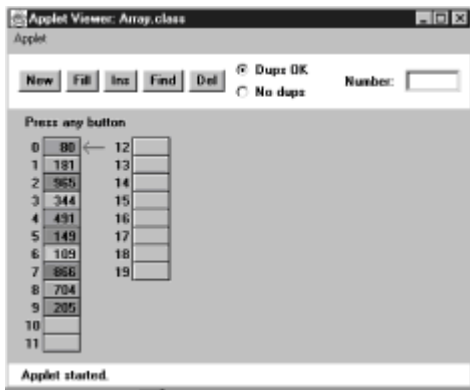

Figure 2.1: The Array Workshop applet

This applet demonstrates the three fundamental procedures mentioned above:

- The Ins button inserts a new data item.
- The Find button searches for specified data item.
- The Del button deletes a specified data item.

Using the New button, you can create a new array of a size you specify. You can fill this array with as many data items as you want using the Fill button. Fill creates a set of items and randomly assigns them numbers and colors. The numbers are in the range 0 to 999. You can't create an array of more than 60 cells, and you can't, of course, fill more data items than there are array cells.

Also, when you create a new array, you'll need to decide whether duplicate items will be allowed; we'll return to this question in a moment. The default value is no duplicates and the No Dups radio button is selected to indicate this.

Insertion

Start with the default arrangement of 20 cells and 10 data items and the No Dups button checked. You insert a baseball player's number into the array when the player arrives at the practice field, having been dropped off by a parent. To insert a new item, press the Ins button once. You'll be prompted to enter the value of the item:

```
Enter key of item to insert
```

Type a number, say 678, into the text field in the upper-right corner of the applet. (Yes, it is hard to get three digits on the back of a kid's shirt.) Press Ins again and the applet will confirm your choice:

```
Will insert item with key 678
```

A final press of the button will cause a data item, consisting of this value and a random color, to appear in the first empty cell in the array. The prompt will say something like:

```
Inserted item with key 678 at index 10
```

Each button press in a Workshop applet corresponds to a step that an algorithm carries out. The more steps required, the longer the algorithm takes. In the Array Workshop applet the insertion process is very fast, requiring only a single step. This is because a

new item is always inserted in the first vacant cell in the array, and the algorithm knows where this is because it knows how many items are already in the array. The new item is simply inserted in the next available space. Searching and deletion, however, are not so fast.

In no-duplicates mode you're on your honor not to insert an item with the same key as an existing item. If you do, the applet displays an error message, but it won't prevent the insertion. The assumption is that you won't make this mistake.

Searching

Click the Find button. You'll be prompted for the key number of the person you're looking for. Pick a number that appears on an item somewhere in the middle of the array. Type in the number and repeatedly press the Find button. At each button press, one step in the algorithm is carried out. You'll see the red arrow start at cell 0 and move methodically down the cells, examining a new one each time you push the button. The index number in the message

```
Checking next cell, index = 2
```

will change as you go along. When you reach the specified item, you'll see the message

```
Have found item with key 505
```

or whatever key value you typed in. Assuming duplicates are not allowed, the search will terminate as soon as an item with the specified key value is found.

If you have selected a key number that is not in the array, the applet will examine every occupied cell in the array before telling you that it can't find that item.

Notice that (again assuming duplicates are not allowed) the search algorithm must look through an average of half the data items to find a specified item. Items close to the beginning of the array will be found sooner, and those toward the end will be found later. If N is the number of items, then the average number of steps needed to find an item is $N/2$. In the worst-case scenario, the specified item is in the last occupied cell, and N steps will be required to find it.

As we noted, the time an algorithm takes to execute is proportional to the number of steps, so searching takes much longer on the average ($N/2$ steps) than insertion (one step).

Deletion

To delete an item you must first find it. After you type in the number of the item to be deleted, repeated button presses will cause the arrow to move, step by step, down the array until the item is located. The next button press deletes the item and the cell becomes empty. (Strictly speaking, this step isn't necessary because we're going to copy over this cell anyway, but deleting the item makes it clearer what's happening.)

Implicit in the deletion algorithm is the assumption that *holes* are not allowed in the array. A hole is one or more empty cells that have filled cells above them (at higher index numbers). If holes are allowed, all the algorithms become more complicated because they must check to see if a cell is empty before examining its contents. Also, the algorithms become less efficient because they must waste time looking at unoccupied cells. For these reasons, occupied cells must be arranged contiguously: no holes allowed.

Therefore, after locating the specified item and deleting it, the applet must shift the contents of each subsequent cell down one space to fill in the hole. Figure 2.2 shows an

example.

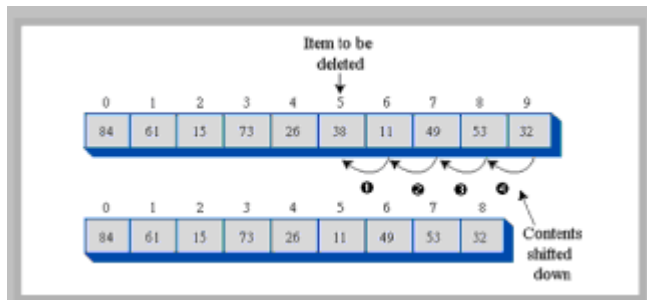

Figure2.2: Deleting an item

If the item in cell 5 (38, in the figure) is deleted, then the item in 6 would shift into 5, the item in 7 would shift into 6, and so on to the last occupied cell. During the deletion process, once the item is located, the applet will shift down the contents of the higher-indexed cells as you continue to press the Del button.

A deletion requires (assuming no duplicates are allowed) searching through an average of $N/2$ elements, and then moving the remaining elements (an average of $N/2$ moves) to fill up the resulting hole. This is N steps in all.

The Duplicates Issue

When you design a data storage structure, you need to decide whether items with duplicate keys will be allowed. If you're talking about a personnel file and the key is an employee number, then duplicates don't make much sense; there's no point in assigning the same number to two employees. On the other hand, if the key value is last names, then there's a distinct possibility several employees will have the same key value, so duplicates should be allowed.

Of course, for the baseball players, duplicate numbers should not be allowed. It would be hard to keep track of the players if more than one wore the same number.

The Array Workshop applet lets you select either option. When you use New to create a new array, you're prompted to specify both its size and whether duplicates are permitted. Use the radio buttons Dups OK or No Dups to make this selection.

If you're writing a data storage program in which duplicates are not allowed, you may need to guard against human error during an insertion by checking all the data items in the array to ensure that none of them already has the same key value as the item being inserted. This is inefficient, however, and increases the number of steps required for an insertion from one to N . For this reason, our applet does not perform this check.

Searching with Duplicates

Allowing duplicates complicates the search algorithm, as we noted. Even if it finds a match, it must continue looking for possible additional matches until the last occupied cell. At least this is one approach; you could also stop after the first match. It depends on whether the question is "Find me everyone with blue eyes" or "Find me someone with blue eyes."

When the Dups OK button is selected, the applet takes the first approach, finding all items matching the search key. This always requires N steps, because the algorithm must go all the way to the last occupied cell.

Insertion with Duplicates

Insertion is the same with duplicates allowed as when they're not: a single step inserts the new item. But remember, if duplicates are not allowed, and there's a possibility the user will attempt to input the same key twice, you may need to check every existing item before doing an insertion.

Deletion with Duplicates

Deletion may be more complicated when duplicates are allowed, depending on exactly how "deletion" is defined. If it means to delete only the first item with a specified value, then, on the average, only $N/2$ comparisons and $N/2$ moves are necessary. This is the same as when no duplicates are allowed.

But if deletion means to delete every item with a specified key value, then the same operation may require multiple deletions. This will require checking N cells and (probably) moving more than $N/2$ cells. The average depends on how the duplicates are distributed throughout the array.

The applet assumes this second meaning and deletes multiple items with the same key. This is complicated, because each time an item is deleted, subsequent items must be shifted farther. For example, if three items are deleted, then items beyond the last deletion will need to be shifted three spaces. To see how this works, set the applet to Dups OK and insert three or four items with the same key. Then try deleting them.

Table 2.1 shows the average number of comparisons and moves for the three operations, first where no duplicates are allowed and then where they are allowed. N is the number of items in the array. Inserting a new item counts as one move.

You can explore these possibilities with the Array Workshop applet.

Table 2.1: Duplicates OK Versus No Duplicates

	No Duplicates	Duplicates OK
Search	$N/2$ comparisons	N comparisons
Insertion	No comparisons, one move	No comparisons, one move
Deletion	$N/2$ comparisons, $N/2$ moves	N comparisons, more than $N/2$ moves

The difference between N and $N/2$ is not usually considered very significant, except when fine-tuning a program. Of more importance, as we'll discuss toward the end of this chapter, is whether an operation takes one step, N steps, $\log(N)$ steps, or N^2 steps.

Not Too Swift

One of the significant things to notice when using the Array applet is the slow and methodical nature of the algorithms. With the exception of insertion, the algorithms involve stepping through some or all of the cells in the array. Different data structures offer much

faster (but more complex) algorithms. We'll see one, the binary search on an ordered array, [later in this chapter](#), and others throughout this book.

The Basics of Arrays in Java

The preceding section showed graphically the primary algorithms used for arrays. Now we'll see how to write programs to carry out these algorithms, but we first want to cover a few of the fundamentals of arrays in Java.

If you're a Java expert, you can skip ahead to the next section, but even C and C++ programmers should stick around. Arrays in Java use syntax similar to that in C and C++ (and not that different from other languages), but there are nevertheless some unique aspects to the Java approach.

Creating an Array

As we noted in [Chapter 1](#), there are two kinds of data in Java: primitive types (such as `int` and `double`), and objects. In many programming languages (even object-oriented ones like C++) arrays are a primitive type, but in Java they're treated as objects. Accordingly you must use the `new` operator to create an array:

```
int[] intArray;           // defines a reference to an array

intArray = new int[100];  // creates the array, and
                           // sets intArray to refer to it
```

or the equivalent single-statement approach:

```
int[] intArray = new int[100];
```

The `[]` operator is the sign to the compiler we're naming an array object and not an ordinary variable. You can also use an alternative syntax for this operator, placing it after the name instead of the type:

```
int intArray[] = new int[100]; // alternative syntax
```

However, placing the `[]` after the `int` makes it clear that the `[]` is part of the type, not the name.

Because an array is an object, its name—`intArray` in the code above—is a reference to an array; it's not the array itself. The array is stored at an address elsewhere in memory, and `intArray` holds only this address.

Arrays have a `length` field, which you can use to find the size, in bytes, of an array:

```
int arrayLength = intArray.length; // find array length
```

Remember that this is the total number of bytes occupied by the array, not the number of data items you have placed in it. As in most programming languages, you can't change the size of an array after it's been created.

Accessing Array Elements

Array elements are accessed using square brackets. This is similar to how other languages work:

```
temp = intArray[3]; // get contents of fourth element of array
intArray[7] = 66;   // insert 66 into the eighth cell
```

Remember that in Java, as in C and C++, the first element is numbered 0, so that the indices in an array of 10 elements run from 0 to 9.

If you use an index that's less than 0 or greater than the size of the array less 1, you'll get the "Array Index Out of Bounds" runtime error. This is an improvement on C and C++, which don't check for out-of-bounds indices, thus causing many program bugs.

Initialization

Unless you specify otherwise, an array of integers is automatically initialized to 0 when it's created. Unlike C++, this is true even of arrays defined within a method (function). If you create an array of objects, like this:

```
autoData[] carArray = new autoData[4000];
```

then, until they're given explicit values, the array elements contain the special `null` object. If you attempt to access an array element that contains `null`, you'll get the runtime error "Null Pointer Assignment." The moral is to make sure you assign something to an element before attempting to access it.

You can initialize an array of a primitive type to something besides 0 using this syntax:

```
int[] intArray = { 0, 3, 6, 9, 12, 15, 18, 21, 24, 27 };
```

Perhaps surprisingly, this single statement takes the place of both the reference declaration and the use of `new` to create the array. The numbers within the curly braces are called the *initialization list*. The size of the array is determined by the number of values in this list.

An Array Example

Let's look at some example programs that show how an array can be used. We'll start with an old-fashioned procedural version, and then show the equivalent objectoriented approach. Listing 2.1 shows the old-fashioned version, called `array.java`.

Listing 2.1 `array.java`

```
// array.java
// demonstrates Java arrays
// to run this program: C>java ArrayApp
import java.io.*;           // for I/O
////////////////////////////////////
class ArrayApp
{
    public static void main(String[] args) throws IOException
    {
        int[] arr;           // reference
        arr = new int[100];  // make array
        int nElems = 0;      // number of items
        int j;               // loop counter
        int searchKey;       // key of item to search for
```

```

//-----
-
    arr[0] = 77;           // insert 10 items
    arr[1] = 99;
    arr[2] = 44;
    arr[3] = 55;
    arr[4] = 22;
    arr[5] = 88;
    arr[6] = 11;
    arr[7] = 00;
    arr[8] = 66;
    arr[9] = 33;
    nElems = 10;         // now 10 items in array

//-----
-
    for(j=0; j<nElems; j++) // display items
        System.out.print(arr[j] + " ");
    System.out.println("");

//-----
-
    searchKey = 66;       // find item with key 66
    for(j=0; j<nElems; j++) // for each element,
        if(arr[j] == searchKey) // found item?
            break;           // yes, exit before end
    if(j == nElems)       // at the end?
        System.out.println("Can't find " + searchKey); // yes
    else
        System.out.println("Found " + searchKey); // no

//-----
-
    searchKey = 55;       // delete item with key 55
    for(j=0; j<nElems; j++) // look for it
        if(arr[j] == searchKey)
            break;
    for(int k=j; k<nElems; k++) // move higher ones
down    arr[k] = arr[k+1];
        nElems--;         // decrement size

//-----
-
    for(j=0; j<nElems; j++) // display items
        System.out.print( arr[j] + " ");
    System.out.println("");
} // end main()
} // end class ArrayApp

```

In this program, we create an array called `arr`, place 10 data items (kids' numbers) in it, search for the item with value 66 (the shortstop, Louisa), display all the items, remove the item with value 55 (Freddy, who had a dentist appointment), and then display the remaining nine items. The output of the program looks like this:

```
77 99 44 55 22 88 11 0 66 33
Found 66
77 99 44 22 88 11 0 66 33
```

The data we're storing in this array is type `int`. We've chosen a primitive type to simplify the coding. Generally the items stored in a data structure consist of several fields, so they are represented by objects rather than primitive types. We'll see an example of this toward the end of this chapter.

Insertion

Inserting an item into the array is easy; we use the normal array syntax

```
arr[0] = 77;
```

We also keep track of how many items we've inserted into the array with the `nElems` variable.

Searching

The `searchKey` variable holds the value we're looking for. To search for an item, we step through the array, comparing `searchKey` with each element. If the loop variable `j` reaches the last occupied cell with no match being found, then the value isn't in the array. Appropriate messages are displayed: "Found 66" or "Can't find 27."

Deletion

Deletion begins with a search for the specified item. For simplicity we assume (perhaps rashly) that the item is present. When we find it, we move all the items with higher index values down one element to fill in the "hole" left by the deleted element, and we decrement `nElems`. In a real program, we'd also take appropriate action if the item to be deleted could not be found.

Display

Displaying all the elements is straightforward: we step through the array, accessing each one with `arr[j]` and displaying it.

Program Organization

The organization of `array.java` leaves something to be desired. There is only one class, `ArrayApp`, and this class has only one method, `main()`. The program is essentially an old-fashioned procedural program. Let's see if we can make it easier to understand (among other benefits) by making it more object-oriented.

We're going to provide a gradual introduction to an object-oriented approach, using two steps. In the first, we'll separate the data storage structure (the array) from the rest of the program. This remaining part of the program will become a *user* of the structure. In the second step, we'll improve the communication between the storage structure and its user.

Dividing a Program into Classes

The `array.java` program essentially consisted of one big method. We can reap many benefits by dividing the program into classes. What classes? The data storage structure itself is one candidate, and the part of the program that uses this data structure is

another. By dividing the program into these two classes we can clarify the functionality of the program, making it easier to design and understand (and in real programs to modify and maintain).

In `array.java` we used an array as a data storage structure, but we treated it simply as a language element. Now we'll encapsulate the array in a class, called `LowArray`. We'll also provide class methods by which objects of other classes (the `LowArrayApp` class in this case) can access the array. These methods allow communication between `LowArray` and `LowArrayApp`.

Our first design of the `LowArray` class won't be entirely successful, but it will demonstrate the need for a better approach. The `lowArray.java` program in Listing 2.2 shows how it looks.

Listing 2.2 The `lowArray.java` Program

```
// lowArray.java
// demonstrates array class with low-level interface
// to run this program: C>java LowArrayApp
import java.io.*;                // for I/O
////////////////////////////////////
class LowArray
{
    private double[] a;          // ref to array a

    public LowArray(int size)    // constructor
    {
        a = new double[size];
    }

                                // put element into array
    public void setElem(int index, double value)
    {
        a[index] = value;
    }

    public double getElem(int index) // get element from array
    {
        return a[index];
    }
} // end class LowArray

////////////////////////////////////

class LowArrayApp
{
    public static void main(String[] args)
    {
        LowArray arr;           // reference
        arr = new LowArray(100); // create LowArray object
        int nElems = 0;         // number of items in array
        int j;                  // loop variable

        arr.setElem(0, 77);     // insert 10 items
        arr.setElem(1, 99);
    }
}
```

```

arr.setElem(2, 44);
arr.setElem(3, 55);
arr.setElem(4, 22);
arr.setElem(5, 88);
arr.setElem(6, 11);
arr.setElem(7, 00);
arr.setElem(8, 66);
arr.setElem(9, 33);
nElems = 10;                // now 10 items in array

//-----
-
for(j=0; j<nElems; j++)      // display items
    System.out.print(arr.getElem(j) + " ");
System.out.println("");

//-----
-
int searchKey = 26;          // search for data item
for(j=0; j<nElems; j++)     // for each element,
    if(arr.getElem(j) == searchKey) // found item?
        break;
if(j == nElems)             // no
    System.out.println("Can't find " + searchKey);
else                        // yes
    System.out.println("Found " + searchKey);

//-----
-
                                // delete value 55
for(j=0; j<nElems; j++)     // look for it
    if(arr.getElem(j) == 55)
        break;
for(int k=j; k<nElems; k++) // move higher ones
down    arr.setElem(k, arr.getElem(k+1) );
        nElems--;          // decrement size

//-----
-
for(j=0; j<nElems; j++)     // display items
    System.out.print( arr.getElem(j) + " ");
System.out.println("");
} // end main()
} // end class LowArrayApp

```

The output from this program is similar to that from `array.java`, except that we try to find a non-existent key value (26) before deleting the item with the key value 55:

```
77 99 44 55 22 88 11 0 66 33
```

```
Can't find 26
```

```
77 99 44 22 88 11 0 66 33
```

Classes `LowArray` and `LowArrayApp`

In `lowArray.java`, we essentially wrap the class `LowArray` around an ordinary Java array. The array is hidden from the outside world inside the class; it's private, so only `LowArray` class methods can access it. There are three `LowArray` methods: `setElem()` and `getElem()`, which insert and retrieve an element, respectively; and a constructor, which creates an empty array of a specified size.

Another class, `LowArrayApp`, creates an object of the `LowArray` class and uses it to store and manipulate data. Think of `LowArray` as a tool, and `LowArrayApp` as a user of the tool. We've divided the program into two classes with clearly defined roles. This is a valuable first step in making a program object-oriented.

A class used to store data objects, as is `LowArray` in the `lowArray.java` program, is sometimes called a *container class*. Typically, a container class not only stores the data but provides methods for accessing the data, and perhaps also sorting it and performing other complex actions on it.

Class Interfaces

We've seen how a program can be divided into separate classes. How do these classes interact with each other? Communication between classes, and the division of responsibility between them, are important aspects of object-oriented programming.

This is especially true when a class may have many different users. Typically a class can be used over and over by different users (or the same user) for different purposes. For example, it's possible that someone might use the `LowArray` class in some other program to store the serial numbers of their traveler's checks. The class can handle this just as well as it can store the numbers of baseball players.

If a class is used by many different programmers, the class should be designed so that it's easy to use. The way that a class user relates to the class is called the class *interface*. Because class fields are typically private, when we talk about the interface we usually mean the class methods: what they do and what their arguments are. It's by calling these methods that a class user interacts with an object of the class. One of the important advantages conferred by object-oriented programming is that a class interface can be designed to be as convenient and efficient as possible. Figure 2.3 is a fanciful interpretation of the `LowArray` interface.

Not So Convenient

The interface to the `LowArray` class in `lowArray.java` is not particularly convenient. The methods `setElem()` and `getElem()` operate on a low conceptual level, performing exactly the same tasks as the `[]` operator in an ordinary Java array. The class user, represented by the `main()` method in the `LowArrayApp` class, ends up having to carry out the same low-level operations it did in the non-class version of an array in the `array.java` program. The only difference was that it related to `setElem()` and `getElem()` instead of the `[]` operator. It's not clear that this is an improvement.

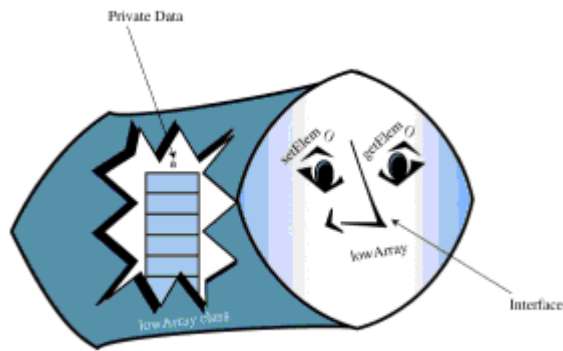

Figure 2.3: The *LowArray* interface

Also notice that there's no convenient way to display the contents of the array. Somewhat crudely, the `LowArrayApp` class simply uses a `for` loop and the `getElem()` method for this purpose. We could avoid repeated code by writing a separate method for `LowArrayApp` that it could call to display the array contents, but is it really the responsibility of the `LowArrayApp` class to provide this method?

Thus `lowArray.java` demonstrates how you can divide a program into classes, but it really doesn't buy us too much in practical terms. Let's see how to redistribute responsibilities between the classes to obtain more of the advantages of OOP.

Who's Responsible for What?

In the `lowArray.java` program, the `main()` routine in the `LowArrayApp` class, the user of the data storage structure must keep track of the indices to the array. For some users of an array who need random access to array elements and don't mind keeping track of the index numbers, this arrangement might make sense. For example, sorting an array, as we'll see in the [next chapter](#), can make efficient use of this direct "hands-on" approach.

However, in a typical program the user of the data storage device won't find access to the array indices to be helpful or relevant. In the Cardfile program in [Chapter 1](#), for example, if the card data were stored in an array, and you wanted to insert a new card, it would be easier not to have to worry about exactly where in the array it is going to go.

The `highArray.java` Example

Our next example program shows an improved interface for the storage structure class, called `HighArray`. Using this interface, the class user (the `HighArrayApp` class) no longer needs to think about index numbers. The `setElem()` and `getElem()` methods are gone, replaced by `insert()`, `find()`, and `delete()`. These new methods don't require an index number as an argument, because the class takes responsibility for handling index numbers. The user of the class (`HighArrayApp`) is free to concentrate on the *what* instead of the *how*: what's going to be inserted, deleted, and accessed, instead of exactly how these activities are carried out.

Figure 2.4 shows the `HighArray` interface and Listing 2.3 shows the `highArray.java` program.

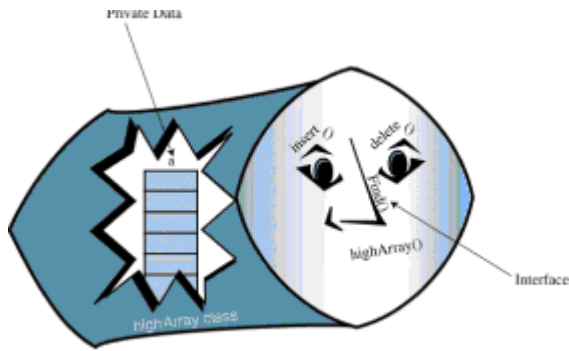

Figure 2.4: The *HighArray* interface

Listing 2.3 The *highArray.java* Program

```
// highArray.java
// demonstrates array class with high-level interface
// to run this program: C>java HighArrayApp
import java.io.*;                               // for I/O
/////////////////////////////////////////////////
class HighArray
{
    private double[] a;                          // ref to array a
    private int nElems;                          // number of data items

    //-----
-   public HighArray(int max)                    // constructor
    {
        a = new double[max];                    // create the array
        nElems = 0;                             // no items yet
    }

    //-----
-   public boolean find(double searchKey)
    {
        // find specified value
        int j;
        for(j=0; j<nElems; j++)                  // for each element,
            if(a[j] == searchKey)               // found item?
                break;                          // exit loop before end
        if(j == nElems)                          // gone to end?
            return false;                       // yes, can't find it
        else
            return true;                        // no, found it
    } // end find()

    //-----
-   public void insert(double value)            // put element into array
    {
        a[nElems] = value;                      // insert it
    }
}
```

```

        nElems++;                // increment size
    }

//-----
-
public boolean delete(double value)
{
    int j;
    for(j=0; j<nElems; j++)      // look for it
        if( value == a[j] )
            break;
    if(j==nElems)                // can't find it
        return false;
    else                          // found it
    {
        for(int k=j; k<nElems; k++) // move higher ones down
            a[k] = a[k+1];
        nElems--;                // decrement size
        return true;
    }
} // end delete()

//-----
-
public void display()           // displays array contents
{
    for(int j=0; j<nElems; j++)  // for each element,
        System.out.print(a[j] + " "); // display it
    System.out.println("");
}

//-----
-
} // end class HighArray

////////////////////////////////////

class HighArrayApp
{
    public static void main(String[] args)
    {
        int maxSize = 100;        // array size
        HighArray arr;           // reference to array
        arr = new HighArray(maxSize); // create the array

        arr.insert(77);          // insert 10 items
        arr.insert(99);
        arr.insert(44);
        arr.insert(55);
        arr.insert(22);
        arr.insert(88);
        arr.insert(11);
        arr.insert(00);
    }
}

```

```

arr.insert(66);
arr.insert(33);

arr.display();           // display items

int searchKey = 35;      // search for item
if( arr.find(searchKey) )
    System.out.println("Found " + searchKey);
else
    System.out.println("Can't find " + searchKey);

arr.delete(00);          // delete 3 items
arr.delete(55);
arr.delete(99);

arr.display();           // display items again
} // end main()

} // end class HighArrayApp

```

The `HighArray` class is now wrapped around the array. In `main()`, we create an array of this class and carry out almost the same operations as in the `lowArray.java` program: we insert 10 items, search for an item—one that isn't there—and display the array contents. Because it's so easy, we delete three items (0, 55, and 99) instead of one, and finally display the contents again. Here's the output:

```

77 99 44 55 22 88 11 0 66 33
Can't find 35
77 44 22 88 11 66 33

```

Notice how short and simple `main()` is. The details that had to be handled by `main()` in `lowArray.java` are now handled by `HighArray` class methods.

In the `HighArray` class, the `find()` method looks through the array for the item whose key value was passed to it as an argument. It returns `true` or `false`, depending on whether it finds the item or not.

The `insert()` method places a new data item in the next available space in the array. A field called `nElements` keeps track of the number of array cells that are actually filled with data items. The `main()` method no longer needs to worry about how many items are in the array.

The `delete()` method searches for the element whose key value was passed to it as an argument, and when it finds it, shifts all the elements in higher index cells down one cell, thus writing over the deleted value; it then decrements `nElements`.

We've also included a `display()` method, which displays all the values stored in the array.

The User's Life Made Easier

In `lowArray.java`, the code in `main()` to search for an item took eight lines; in `highArray.java`, it takes only one. The class user, the `HighArrayApp` class, need not worry about index numbers or any other array details. Amazingly, the class user does not even need to know what kind of data structure the `HighArray` class is using to store

the data. The structure is hidden behind the interface. In fact, in the next section, we'll see the same interface used with a somewhat different data structure.

Abstraction

The process of separating the *how* from the *what*—how an operation is performed inside a class, as opposed to what's visible to the class user—is called *abstraction*. Abstraction is an important aspect of software engineering. By abstracting class functionality we make it easier to design a program, because we don't need to think about implementation details at too early a stage in the design process.

The Ordered Workshop Applet

Imagine an array in which the data items are arranged in order of ascending key values; that is, with the smallest value at index 0, and each cell holding a value larger than the cell below. Such an array is called an *ordered array*.

When we insert an item into this array, the correct location must be found for the insertion: just above a smaller value and just below a larger one. Then all the larger values must be moved up to make room.

Why would we want to arrange data in order? One advantage is that we can speed up search times dramatically using a *binary search*.

Start the Ordered Workshop applet. You'll see an array; it's similar to the one in the Array Workshop applet, but the data is ordered. Figure 2.5 shows how this looks.

In the ordered array we've chosen to not allow duplicates. As we saw earlier, this speeds up searching somewhat but slows down insertion.

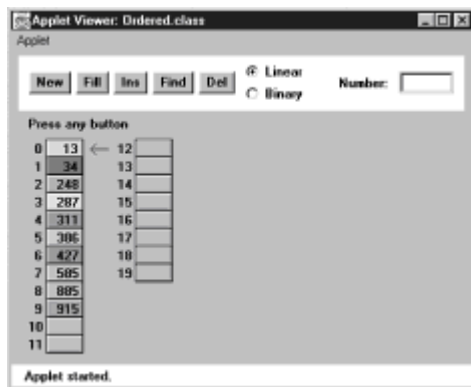

Figure 2.5: The Ordered Workshop applet

Linear Search

Two search algorithms are available for the Ordered Workshop applet: linear and binary. Linear search is the default. Linear searches operate in much the same way as the searches in the unordered array in the Array applet: the red arrow steps along, looking for a match. The difference is that in the ordered array, the search quits if an item with a larger key is found.

Try this out. Make sure the Linear radio button is selected. Then use the Find button to search for a non-existent value that, if it were present, would fit somewhere in the middle of the array. In Figure 2.5, this might be 400. You'll see that the search terminates when the first item larger than 400 is reached, it's 427 in the figure. The algorithm knows there's

no point looking further.

Try out the Ins and Del buttons as well. Use Ins to insert an item with a key value that will go somewhere in the middle of the existing items. You'll see that insertion requires moving all the items with larger key values larger than the item being inserted.

Use the Del button to delete an item from the middle of the array. Deletion works much the same as it did in the Array applet, shifting items with higher index numbers down to fill in the hole left by the deletion. In the ordered array, however, the deletion algorithm can quit partway through if it doesn't find the item, just as the search routine can.

Binary Search

The payoff for using an ordered array comes when we use a binary search. This kind of search is much faster than a linear search, especially for large arrays.

The Guess-a-Number Game

Binary search uses the same approach you did as a kid (if you were smart) to guess a number in the well-known children's guessing game. In this game, a friend asks you to guess a number she's thinking of between 1 and 100. When you guess a number, she'll tell you one of three things: your guess is larger than the number she's thinking of, it's smaller, or you guessed correctly.

To find the number in the fewest guesses, you should always start by guessing 50. If she says your guess is too low, you deduce the number is between 51 and 100, so your next guess should be 75 (halfway between 51 and 100). If she says it's too high, you deduce the number is between 1 and 49, so your next guess should be 25.

Each guess allows you to divide the range of possible values in half. Finally, the range is only one number long, and that's the answer.

Notice how few guesses are required to find the number. If you used a linear search, guessing first 1, then 2, then 3, and so on, it would take you, on the average, 50 guesses to find the number. In a binary search each guess divides the range of possible values in half, so the number of guesses required is far fewer. Table 2.2 shows a game session when the number to be guessed is 33.

Table 2.2: Guessing a Number

Step Number	Number Guessed	Result	Range of Possible Values
0			1-100
1	50	Too high	1-49
2	25	Too low	26-49
3	37	Too high	26-36
4	31	Too low	32-36

5	34	Too high	32-33
6	32	Too low	33-33
7	33	Correct	

The correct number is identified in only seven guesses. This is the maximum. You might get lucky and guess the number before you've worked your way all the way down to a range of one. This would happen if the number to be guessed was 50, for example, or 34.

Binary Search in the Ordered Workshop Applet

To perform a binary search with the Ordered Workshop applet, you must use the New button to create a new array. After the first press you'll be asked to specify the size of the array (maximum 60) and which kind of searching scheme you want: linear or binary. Choose binary by clicking the Binary radio button. After the array is created, use the Fill button to fill it with data items. When prompted, type the amount (not more than the size of the array). A few more presses fills in all the items.

Once the array is filled, pick one of the values in the array and see how the Find button can be used to locate it. After a few preliminary presses, you'll see the red arrow pointing to the algorithm's current guess, and you'll see the range shown by a vertical blue line adjacent to the appropriate cells. Figure 2.6 depicts the situation when the range is the entire array.

At each press of the Find button the range is halved and a new guess is chosen in the middle of the range. Figure 2.7 shows the next step in the process.

Even with a maximum array size of 60 items, a half-dozen button presses suffices to locate any item.

Try using the binary search with different array sizes. Can you figure out how many steps are necessary before you run the applet? We'll return to this question in the last section of this chapter.

Notice that the insertion and deletion operations also employ the binary search (when it's selected). The place where an item should be inserted is found with a binary search, as is an item to be deleted. In this applet, items with duplicate keys are not permitted.

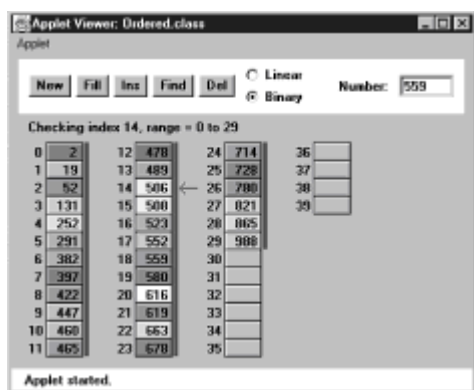

Figure 2.6: Initial range in binary search

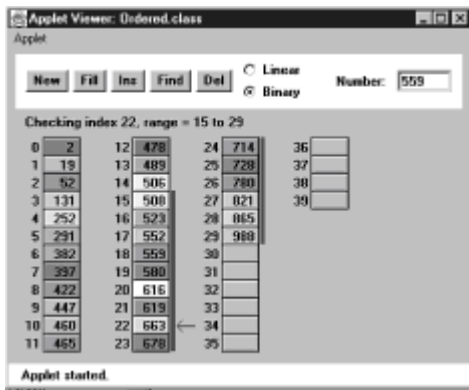

Figure 2.7: Range in step 2 of binary search

Java Code for an Ordered Array

Let's examine some Java code that implements an ordered array. We'll use the `OrdArray` class to encapsulate the array and its algorithms. The heart of this class is the `find()` method, which uses a binary search to locate a specified data item. We'll examine this method in detail before showing the complete program.

Binary Search with the `find()` Method

The `find()` method searches for a specified item by repeatedly dividing in half the range of array elements to be considered. Here's how this method looks:

```
public int find(double searchKey)
{
    int lowerBound = 0;
    int upperBound = nElems-1;
    int curIn;

    while(true)
    {
        curIn = (lowerBound + upperBound) / 2;
        if(a[curIn]==searchKey)
            return curIn;           // found it
        else if(lowerBound > upperBound)
            return nElems;         // can't find it
        else                        // divide range
        {
            if(a[curIn] < searchKey)
                lowerBound = curIn + 1; // it's in upper half
            else
                upperBound = curIn - 1; // it's in lower half
        } // end else divide range
    } // end while

} // end find()
```

The method begins by setting the `lowerBound` and `upperBound` variables to the first and last occupied cells in the array. This specifies the range where the item we're looking for, `searchKey`, may be found. Then, within the `while` loop, the current index, `curIn`,

is set to the middle of this range.

If we're lucky, `curIn` may already be pointing to the desired item, so we first check if this is true. If it is, we've found the item so we return with its index, `curIn`.

Each time through the loop we divide the range in half. Eventually it will get so small it can't be divided any more. We check for this in the next statement: If `lowerBound` is greater than `upperBound`, the range has ceased to exist. (When `lowerBound` equals `upperBound` the range is one and we need one more pass through the loop.) We can't continue the search without a valid range, but we haven't found the desired item, so we return `nElems`, the total number of items. This isn't a valid index, because the last filled cell in the array is `nElems-1`. The class user interprets this value to mean that the item wasn't found.

If `curIn` is not pointing at the desired item, and the range is still big enough, then we're ready to divide the range in half. We compare the value at the current index, `a[curIn]`, which is in the middle of the range, with the value to be found, `searchKey`.

If `searchKey` is larger, then we know we should look in the upper half of the range. Accordingly, we move `lowerBound` up to `curIn`.

Actually we move it one cell beyond `curIn`, because we've already checked `curIn` itself at the beginning of the loop.

If `searchKey` is smaller than `a[curIn]`, we know we should look in the lower half of the range. So we move `upperBound` down to one cell below `curIn`. Figure 2.8 shows how the range is altered in these two situations.

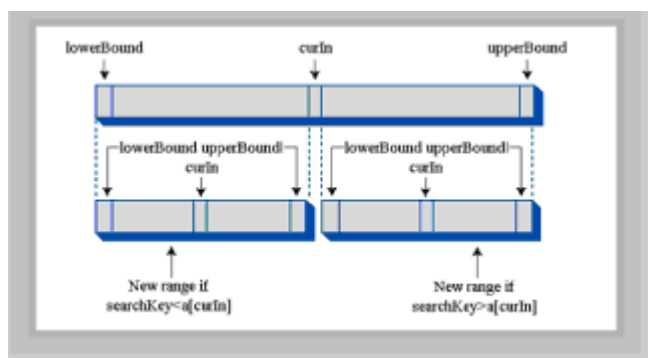

Figure 2.8: Dividing the range in a binary search

The `OrdArray` Class

In general, the `orderedArray.java` program is similar to `highArray.java`. The main difference is that `find()` uses a binary search, as we've seen.

We could have used a binary search to locate the position where a new item will be inserted. This involves a variation on the `find()` routine, but for simplicity we retain the linear search in `insert()`. The speed penalty may not be important because, as we've seen, an average of half the items must be moved anyway when an insertion is performed, so insertion will not be very fast even if we locate the item with a binary search. However, for the last ounce of speed, you could change the initial part of `insert()` to a binary search (as is done in the `Ordered Workshop` applet). Similarly, the `delete()` method could call `find()` to figure out the location of the item to be deleted.

The `OrdArray` class includes a new `size()` method, which returns the number of data items currently in the array. This is helpful for the class user, `main()`, when it calls `find()`. If `find()` returns `nElems`, which `main()` can discover with `size()`, then the search was unsuccessful. Listing 2.4 shows the complete listing for the `orderedArray.java` program.

Listing 2.4 The `orderedArray.java` Program

```
// orderedArray.java
// demonstrates ordered array class
// to run this program: C>java OrderedApp
import java.io.*;                                // for I/O
/////////////////////////////////////////////////
class OrdArray
{
    private double[] a;                          // ref to array a
    private int nElems;                          // number of data items

    //-----
-   public OrdArray(int max)                    // constructor
    {
        a = new double[max];                    // create array
        nElems = 0;
    }

    //-----
-   public int size()
        { return nElems; }

    //-----
-   public int find(double searchKey)
    {
        int lowerBound = 0;
        int upperBound = nElems-1;
        int curIn;

        while(true)
        {
            curIn = (lowerBound + upperBound ) / 2;
            if(a[curIn]==searchKey)
                return curIn;                    // found it           else
if(lowerBound > upperBound)
            return nElems;                        // can't find it
            else
                // divide range
            {
                if(a[curIn] < searchKey)
                    lowerBound = curIn + 1; // it's in upper half
                else
                    upperBound = curIn - 1; // it's in lower half
            } // end else divide range
        } // end while
    }
}
```

```

        } // end find()

//-----
-
public void insert(double value) // put element into array
{
    int j;
    for(j=0; j<nElems; j++) // find where it goes
        if(a[j] > value) // (linear search)
            break;
    for(int k=nElems; k>j; k--) // move higher ones up
        a[k] = a[k-1];
    a[j] = value; // insert it
    nElems++; // increment size
} // end insert()

//-----
-
public boolean delete(double value)
{
    int j = find(value);
    if(j==nElems) // can't find it
        return false;
    else // found it
    {
        for(int k=j; k<nElems; k++) // move higher ones down
            a[k] = a[k+1];
        nElems--; // decrement size
        return true;
    }
} // end delete()

//-----
-
public void display() // displays array contents
{
    for(int j=0; j<nElems; j++) // for each element,
        System.out.print(a[j] + " "); // display it
    System.out.println("");
}

//-----
-
} // end class OrdArray

////////////////////////////////////

class OrderedApp
{
    public static void main(String[] args)
    {
        int maxSize = 100; // array size
        OrdArray arr; // reference to array
        arr = new OrdArray(maxSize); // create the array
    }
}

```

```

arr.insert(77);           // insert 10 items
arr.insert(99);
arr.insert(44);
arr.insert(55);
arr.insert(22);
arr.insert(88);
arr.insert(11);
arr.insert(00);
arr.insert(66);
arr.insert(33);

int searchKey = 55;      // search for item
if( arr.find(searchKey) != arr.size() )
    System.out.println("Found " + searchKey);
else
    System.out.println("Can't find " + searchKey);

arr.display();          // display items

arr.delete(00);         // delete 3 items
arr.delete(55);
arr.delete(99);

arr.display();          // display items again
} // end main()

} // end class OrderedApp

```

Advantages of Ordered Arrays

What have we gained by using an ordered array? The major advantage is that search times are much faster than in an unordered array. The disadvantage is that insertion takes longer, because all the data items with a higher key value must be moved up to make room. Deletions are slow in both ordered and unordered arrays, because items must be moved down to fill the hole left by the deleted item.

Ordered arrays are therefore useful in situations in which searches are frequent, but insertions and deletions are not. An ordered array might be appropriate for a database of company employees, for example. Hiring new employees and laying off existing ones would probably be infrequent occurrences compared with accessing an existing employee's record for information or updating it to reflect changes in salary, address, and so on.

A retail store inventory, on the other hand, would not be a good candidate for an ordered array because the frequent insertions and deletions, as items arrived in the store and were sold, would run slowly.

Logarithms

In this section we'll explain how logarithms are used to calculate the number of steps necessary in a binary search. If you're a math major, you can probably skip this section. If math makes you break out in a rash, you can also skip it, except for taking a long, hard look at Table 2.3.

We've seen that a binary search provides a significant speed increase over a linear search. In the number guessing game, with a range from 1 to 100, it takes a maximum of seven guesses to identify any number using a binary search; just as in an array of 100 records, it takes seven comparisons to find a record with a specified key value. How about other ranges? Table 2.3 shows some representative ranges and the number of comparisons needed for a binary search.

Table 2.3: Comparisons needed in Binary Search

Range	Comparisons Needed
10	4
100	7
1,000	10
10,000	14
100,000	17
1,000,000	20
10,000,000	24
100,000,000	27
1,000,000,000	30

Notice the differences between binary search times and linear search times. For very small numbers of items, the difference isn't dramatic. Searching 10 items would take an average of five comparisons with a linear search ($N/2$), and a maximum of four comparisons with a binary search. But the more items there are, the bigger the difference. With 100 items, there are 50 comparisons in a linear search, but only seven in a binary search. For 1,000 items, the numbers are 500 versus 10, and for 1,000,000 items, they're 500,000 versus 20. We can conclude that for all but very small arrays, the binary search is greatly superior.

The Equation

You can verify the results of Table 2.3 by repeatedly dividing a range (from the first column) in half until it's too small to divide further. The number of divisions this process requires is the number of comparisons shown in the second column.

Repeatedly dividing the range by two is an algorithmic approach to finding the number of comparisons. You might wonder if you could also find the number using a simple equation. Of course, there is such an equation and it's worth exploring here because it pops up from time to time in the study of data structures. This formula involves logarithms. (Don't panic yet.)

The numbers in Table 2.3 leave out some interesting data. They don't answer questions like, "What is the exact size of the maximum range that can be searched in five steps?" To solve this, we must create a similar table, but one that starts at the beginning, with a range of one, and works up from there by multiplying the range by two each time. Table 2.4 shows how this looks for the first ten steps.

Table 2.4: Powers of Two

Step s, Same as $\log_2(r)$	Range r	Range Expressed as Power of 2 (2^s)
0	1	2^0
1	2	2^1
2	4	2^2
3	8	2^3
4	16	2^4
5	32	2^5
6	64	2^6
7	128	2^7
8	256	2^8
9	512	2^9
10	1024	2^{10}

For our original problem with a range of 100, we can see that six steps doesn't produce a range quite big enough (64), while seven steps covers it handily (128). Thus, the seven steps that are shown for 100 items in [Table 2.3](#) are correct, as are the 10 steps for a range of 1000.

Doubling the range each time creates a series that's the same as raising two to a power, as shown in the third column of Table 2.4. We can express this as a formula. If s represents steps (the number of times you multiply by two—that is, the power to which two is raised) and r represents the range, then the equation is

$$r = 2^s$$

If you know s, the number of steps, this tells you r, the range. For example, if s is 6, the range is 2^6 , or 64.

The Opposite of Raising Two to a Power

But our original question was the opposite: given the range, we want to know how many comparisons it will take to complete a search. That is, given r , we want an equation that gives us s .

Raising something to a power is the inverse of a logarithm. Here's the formula we want, expressed with a logarithm:

$$s = \log_2(r)$$

This says that the number of steps (comparisons) is equal to the logarithm to the base 2 of the range. What's a logarithm? The base-2 logarithm of a number r is the number of times you must multiply two by itself to get r . In [Table 2.4](#), we show that the numbers in the first column, s , are equal to $\log_2(r)$.

How do you find the logarithm of a number without doing a lot of dividing? Pocket calculators and most computer languages have a log function. This is usually log to the base 10, but you can convert easily to base 2 by multiplying by 3.322. For example, $\log_{10}(100) = 2$, so $\log_2(100) = 2$ times 3.322, or 6.644. Rounded up to the whole number 7, this is what appears in the column to the right of 100 in [Table 2.4](#).

In any case, the point here isn't to calculate logarithms. It's more important to understand the relationship between a number and its logarithm. Look again at [Table 2.3](#), which compares the number of items and the number of steps needed to find a particular item. Every time you multiply the number of items (the range) by a factor of 10, you add only three or four steps (actually 3.322, before rounding off to whole numbers) to the number needed to find a particular element. This is because, as a number grows larger, its logarithm doesn't grow nearly as fast. We'll compare this logarithmic growth rate with that of other mathematical functions when we talk about Big O notation later in this chapter.

Storing Objects

In the Java examples we've shown so far, we've stored primitive variables of type `double` in our data structures. This simplifies the program examples, but it's not representative of how you use data storage structures in the real world. Usually, the data items (records) you want to store are combinations of many fields. For a personnel record, you would store last name, first name, age, Social Security number, and so forth. For a stamp collection, you'd store the name of the country that issued the stamp, its catalog number, condition, current value, and so on.

In our next Java example, we'll show how objects, rather than variables of primitive types, can be stored.

The Person Class

In Java, a data record is usually represented by a class object. Let's examine a typical class used for storing personnel data. Here's the code for the `Person` class:

```
class Person
{
    private String lastName;
    private String firstName;
    private int age;

    //-----
-
    public Person(String last, String first, int a)
        {
            // constructor
```

```

        lastName = last;
        firstName = first;
        age = a;
    }

//-----
-
public void displayPerson()
    {
        System.out.print("    Last name: " + lastName);
        System.out.print(", First name: " + firstName);
        System.out.println(", Age: " + age);
    }

//-----
-
public String getLast()          // get last name
    { return lastName; }
} // end class Person

```

We show only three variables in this class, for a person's last name, first name, and age. Of course, records for most applications would contain many additional fields.

A constructor enables a new `Person` object to be created and its fields initialized. The `displayPerson()` method displays a `Person` object's data, and the `getLast()` method returns the `Person`'s last name; this is the key field used for searches.

The `classDataArray.java` Program

The program that makes use of the `Person` class is similar to the `highArray.java` program that stored items of type `double`. Only a few changes are necessary to adapt that program to handle `Person` objects. Here are the major ones:

- The type of the array `a` is changed to `Person`.
- The key field (the last name) is now a `String` object, so comparisons require the `equals()` method rather than the `==` operator. The `getLast()` method of `Person` obtains the last name of a `Person` object, and `equals()` does the comparison:

```
if( a[j].getLast().equals(searchName) ) // found item?
```

- The `insert()` method creates a new `Person` object and inserts it in the array, instead of inserting a `double` value.

The `main()` method has been modified slightly, mostly to handle the increased quantity of output. We still insert 10 items, display them, search for one, delete three items, and display them all again. Here's the listing for `classDataArray.java`:

```

// classDataArray.java
// data items as class objects
// to run this program: C>java ClassDataApp
import java.io.*;          // for I/O
////////////////////////////////////
class Person
    {

```



```

private String lastName;
private String firstName;
private int age;

//-----
-
public Person(String last, String first, int a)
    {
        // constructor
        lastName = last;
        firstName = first;
        age = a;
    }

//-----
-
public void displayPerson()
    {
        System.out.print("  Last name: " + lastName);
        System.out.print(", First name: " + firstName);
        System.out.println(", Age: " + age);
    }

//-----
-
public String getLast()          // get last name
    { return lastName; }
} // end class Person

////////////////////////////////////

class ClassDataArray
    {
        private Person[] a;          // reference to array
        private int nElems;          // number of data items

//-----
-
public ClassDataArray(int max)    // constructor
    {
        a = new Person[max];        // create the array
        nElems = 0;                 // no items yet
    }

//-----
-
public Person find(String searchName)
    {
        // find specified value
        int j;
        for(j=0; j<nElems; j++)      // for each element,
            if( a[j].getLast().equals(searchName) ) // found
item?
                break;              // exit loop before
end
        if(j == nElems)             // gone to end?
            return null;            // yes, can't find it
    }

```

```

        else
            return a[j];                // no, found it
    } // end find()

//-----
-
                                // put Person into array
public void insert(String last, String first, int age)
    {
        a[nElems] = new Person(last, first, age);
        nElems++;                       // increment size
    }

//-----
-
public boolean delete(String searchName)
    {
        // delete Person from
array
        int j;
        for(j=0; j<nElems; j++)          // look for it
            if( a[j].getLast().equals(searchName) )
                break;
        if(j==nElems)                   // can't find it
            return false;
        else                             // found it
            {
                for(int k=j; k<nElems; k++) // shift down
                    a[k] = a[k+1];
                nElems--;                 // decrement size
                return true;
            }
    } // end delete()

//-----
-
public void displayA()                 // displays array contents
    {
        for(int j=0; j<nElems; j++)     // for each element,
            a[j].displayPerson();       // display it
    }

//-----
-
    } // end class ClassDataArray

////////////////////////////////////

class ClassDataApp
    {
        public static void main(String[] args)
            {
                int maxSize = 100;       // array size
                ClassDataArray arr;      // reference to array
                arr = new ClassDataArray(maxSize); // create the array
            }
    }

```

```

// insert 10 items
arr.insert("Evans", "Patty", 24);
arr.insert("Smith", "Lorraine", 37);
arr.insert("Yee", "Tom", 43);
arr.insert("Adams", "Henry", 63);
arr.insert("Hashimoto", "Sato", 21);
arr.insert("Stimson", "Henry", 29);
arr.insert("Velasquez", "Jose", 72);
arr.insert("Lamarque", "Henry", 54);
arr.insert("Vang", "Minh", 22);
arr.insert("Creswell", "Lucinda", 18);

arr.displayA(); // display items

String searchKey = "Stimson"; // search for item
Person found;
found=arr.find(searchKey);
if(found != null)
    {
        System.out.print("Found ");
        found.displayPerson();
    }
else
    System.out.println("Can't find " + searchKey);

System.out.println("Deleting Smith, Yee, and Creswell");
arr.delete("Smith"); // delete 3 items
arr.delete("Yee");
arr.delete("Creswell");

arr.displayA(); // display items again
} // end main()

} // end class ClassDataApp

```

Here's the output of this program:

```

Last name: Evans, First name: Patty, Age: 24
Last name: Smith, First name: Lorraine, Age: 37
Last name: Yee, First name: Tom, Age: 43
Last name: Adams, First name: Henry, Age: 63
Last name: Hashimoto, First name: Sato, Age: 21
Last name: Stimson, First name: Henry, Age: 29
Last name: Velasquez, First name: Jose, Age: 72
Last name: Lamarque, First name: Henry, Age: 54
Last name: Vang, First name: Minh, Age: 22
Last name: Creswell, First name: Lucinda, Age: 18
Found    Last name: Stimson, First name: Henry, Age: 29
Deleting Smith, Yee, and Creswell
Last name: Evans, First name: Patty, Age: 24
Last name: Adams, First name: Henry, Age: 63
Last name: Hashimoto, First name: Sato, Age: 21

```

```
Last name: Stimson, First name: Henry, Age: 29
Last name: Velasquez, First name: Jose, Age: 72
Last name: Lamarque, First name: Henry, Age: 54

Last name: Vang, First name: Minh, Age: 22
```

This program shows that class objects can be handled by data storage structures in much the same way as primitive types. (Note that a serious program using the last name as a key would need to account for duplicate last names, which would complicate the programming as discussed earlier.)

Big O Notation

Automobiles are divided by size into several categories: subcompacts, compacts, midsize, and so on. These categories provide a quick idea what size car you're talking about, without needing to mention actual dimensions. Similarly, it's useful to have a shorthand way to say how efficient a computer algorithm is. In computer science, this rough measure is called Big O notation.

You might think that in comparing algorithms you would say things like "Algorithm A is twice as fast as algorithm B," but in fact this sort of statement isn't too meaningful. Why not? Because the proportion can change radically as the number of items changes. Perhaps you increase the number of items by 50%, and now A is three times as fast as B. Or you have half as many items, and A and B are now equal. What you need is a comparison that's related to the number of items. Let's see how this looks for the algorithms we've seen so far.

Insertion in an Unordered Array: Constant

Insertion into an unordered array is the only algorithm we've seen that doesn't depend on how many items are in the array. The new item is always placed in the next available position, at `a[nElements]`, and `nElements` is then incremented. This requires the same amount of time no matter how big `N`—the number of items in the array—is. We can say that the time, `T`, to insert an item into an unsorted array is a constant `K`:

$$T = K$$

In a real situation, the actual time (in microseconds or whatever) required by the insertion is related to the speed of the microprocessor, how efficiently the compiler has generated the program code, and other factors. The constant `K` in the equation above is used to account for all such factors. To find out what `K` is in a real situation, you need to measure how long an insertion took. (Software exists for this very purpose.) `K` would then be equal to that time.

Linear Search: Proportional to N

We've seen that, in a linear search of items in an array, the number of comparisons that must be made to find a specified item is, on the average, half of the total number of items. Thus, if `N` is the total number of items, the search time `T` is proportional to half of `N`:

$$T = K * N / 2$$

As with insertions, discovering the value of `K` in this equation would require timing a search for some (probably large) value of `N`, and then using the resulting value of `T` to calculate `K`. Once you knew `K`, then you could calculate `T` for any other value of `N`.

For a handier formula, we could lump the 2 into the K. Our new K is equal to the old K divided by 2. Now we have

$$T = K * N$$

This says that average linear search times are proportional to the size of the array. If an array is twice as big, it will take twice as long to search.

Binary Search: Proportional to log(N)

Similarly, we can concoct a formula relating T and N for a binary search:

$$T = K * \log_2(N)$$

As we saw earlier, the time is proportional to the base 2 logarithm of N. Actually, because any logarithm is related to any other logarithm by a constant (3.322 to go from base 2 to base 10), we can lump this constant into K as well. Then we don't need to specify the base:

$$T = K * \log(N)$$

Don't Need the Constant

Big O notation looks like these formulas, but it dispenses with the constant K. When comparing algorithms you don't really care about the particular microprocessor chip or compiler; all you want to compare is how T changes for different values of N, not what the actual numbers are. Therefore, the constant isn't needed.

Big O notation uses the uppercase letter O, which you can think of as meaning "order of." In Big O notation, we would say that a linear search takes O(N) time, and a binary search takes O(log N) time. Insertion into an unordered array takes O(1), or constant time. (That's the numeral 1 in the parentheses.)

Table 2.5: Running times in Big O Notation

Algorithm	Running Time in Big O Notation
Linear search	O(N)
Binary search	O(log N)
Insertion in unordered array	O(1)
Insertion in ordered array	O(N)
Deletion in unordered array	O(N)
Deletion in ordered array	O(N)

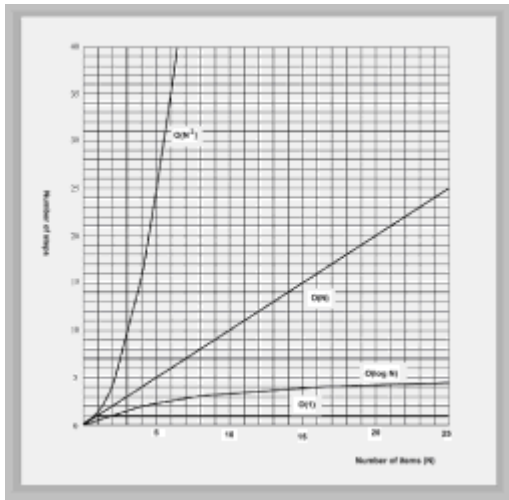

Figure 2.9: Graph of Big O times

[Table 2.5](#) summarizes the running times of the algorithms we've discussed so far.

Figure 2.9 graphs some Big O relationships between time and number of items. Based on this graph, we might rate the various Big O values (very subjectively) like this: $O(1)$ is excellent, $O(\log N)$ is good, $O(N)$ is fair, and $O(N^2)$ is poor. $O(N^2)$ occurs in the bubble sort and also in certain graph algorithms that we'll look at later in this book.

The idea in Big O notation isn't to give an actual figure for running time, but to convey how the running times are affected by the number of items. This is the most meaningful way to compare algorithms, except perhaps actually measuring running times in a real installation.

Why Not Use Arrays for Everything?

They seem to get the job done, so why not use arrays for all data storage? We've already seen some of their disadvantages. In an unordered array you can insert items quickly, in $O(1)$ time, but searching takes slow $O(N)$ time. In an ordered array you can search quickly, in $O(\log N)$ time, but insertion takes $O(N)$ time. For both kinds of arrays, deletion takes $O(N)$ time, because half the items (on the average) must be moved to fill in the hole.

It would be nice if there were data structures that could do everything—insertion, deletion, and searching—quickly, ideally in $O(1)$ time, but if not that, then in $O(\log N)$ time. In the chapters ahead, we'll see how closely this ideal can be approached, and the price that must be paid in complexity.

Another problem with arrays is that their size is fixed when the array is first created with `new`. Usually when the program first starts, you don't know exactly how many items will be placed in the array later on, so you guess how big it should be. If your guess is too large, you'll waste memory by having cells in the array that are never filled. If your guess is too small, you'll overflow the array, causing at best a message to the program's user, and at worst a program crash.

Other data structures are more flexible and can expand to hold the number of items inserted in them. The linked list, discussed in [Chapter 5, "Linked Lists,"](#) is such a structure.

We should mention that Java includes a class called `Vector` that acts much like an array but is expandable. This added capability comes at the expense of some loss of efficiency.

You might want to try creating your own vector class. If the class user is about to overflow the internal array in this class, the insertion algorithm creates a new array of larger size, copies the old array contents to the new array, and then inserts the new item. All this would be invisible to the class user.

Summary

- Arrays in Java are objects, created with the `new` operator.
- Unordered arrays offer fast insertion but slow searching and deletion.
- Wrapping an array in a class protects the array from being inadvertently altered.
- A class interface comprises the methods (and occasionally fields) that the class user can access.
- A class interface can be designed to make things simple for the class user.
- A binary search can be applied to an ordered array.
- The logarithm to the base B of a number A is (roughly) the number of times you can divide A by B before the result is less than 1.
- Linear searches require time proportional to the number of items in an array.
- Binary searches require time proportional to the logarithm of the number of items.
- Big O notation provides a convenient way to compare the speed of algorithms.
- An algorithm that runs in $O(1)$ time is the best, $O(\log N)$ is good, $O(N)$ is fair, and $O(N^2)$ is pretty bad.

Chapter 3: Simple Sorting

Overview

As soon as you create a significant database, you'll probably think of reasons to sort it in various ways. You need to arrange names in alphabetical order, students by grade, customers by zip code, home sales by price, cities in order of increasing population, countries by GNP, stars by magnitude, and so on.

Sorting data may also be a preliminary step to searching it. As we saw in the [last chapter](#), a binary search, which can be applied only to sorted data, is much faster than a linear search.

Because sorting is so important and potentially so time-consuming, it has been the subject of extensive research in computer science, and some very sophisticated methods have been developed. In this chapter we'll look at three of the simpler algorithms: the bubble sort, the selection sort, and the insertion sort. Each is demonstrated with its own Workshop applet. In [Chapter 7, "Advanced Sorting,"](#) we'll look at more sophisticated approaches: Shellsort and quicksort.

The techniques described in this chapter, while unsophisticated and comparatively slow, are nevertheless worth examining. Besides being easier to understand, they are actually better in some circumstances than the more sophisticated algorithms. The insertion sort,

for example, is preferable to quicksort for small files and for almost-sorted files. In fact, an insertion sort is commonly used as a part of a quicksort implementation.

The example programs in this chapter build on the array classes we developed in the [last chapter](#). The sorting algorithms are implemented as methods of similar array classes.

Be sure to try out the Workshop applets included in this chapter. They are more effective in explaining how the sorting algorithms work than prose and static pictures could ever be.

How Would You Do It?

Imagine that your kids-league baseball team (mentioned in [Chapter 1, "Overview,"](#)) is lined up on the field, as shown in Figure 3.1. The regulation nine players, plus an extra, have shown up for practice. You want to arrange the players in order of increasing height (with the shortest player on the left), for the team picture. How would you go about this sorting process?

As a human being, you have advantages over a computer program. You can see all the kids at once, and you can pick out the tallest kid almost instantly; you don't need to laboriously measure and compare everyone. Also, the kids don't need to occupy particular places. They can jostle each other, push each other a little to make room, and stand behind or in front of each other. After some ad hoc rearranging, you would have no trouble in lining up all the kids, as shown in [Figure 3.2](#).

A computer program isn't able to glance over the data in this way. It can only compare two players at once, because that's how the comparison operators work. This tunnel vision on the part of algorithms will be a recurring theme. Things may seem simple to us humans, but the algorithm can't see the big picture and must, therefore, concentrate on the details and follow some simple rules.

The three algorithms in this chapter all involve two steps, executed over and over until the data is sorted:

1. Compare two items.
2. Swap two items or copy one item.

However, each algorithm handles the details in a different way.



Figure 3.1: The unordered baseball team



Figure 3.2: The ordered baseball team

Bubble Sort

The bubble sort is notoriously slow, but it's conceptually the simplest of the sorting algorithms, and for that reason is a good beginning for our exploration of sorting techniques.

Bubble-Sorting the Baseball Players

Imagine that you're nearsighted (like a computer program) so that you can see only two of the baseball players at the same time, if they're next to each other and if you stand very close to them. Given this impediment, how would you sort them? Let's assume there are N players, and the positions they're standing in are numbered from 0 on the left to $N-1$ on the right.

The bubble sort routine works like this. You start at the left end of the line and compare the two kids in positions 0 and 1. If the one on the left (in 0) is taller, you swap them. If the one on the right is taller, you don't do anything. Then you move over one position and compare the kids in positions 1 and 2. Again, if the one on the left is taller, you swap them. This is shown in Figure 3.3.

Here are the rules you're following:

1. Compare two players.
2. If the one on the left is taller, swap them.
3. Move one position right.

You continue down the line this way until you reach the right end. You have by no means finished sorting the kids, but you do know that the tallest kid is on the right. This must be true, because as soon as you encounter the tallest kid, you'll end up swapping him every time you compare two kids, until eventually he (or she) will reach the right end of the line. This is why it's called the bubble sort: as the algorithm progresses, the biggest items "bubble up" to the top end of the array. [Figure 3.4](#) shows the baseball players at the end of the first pass.

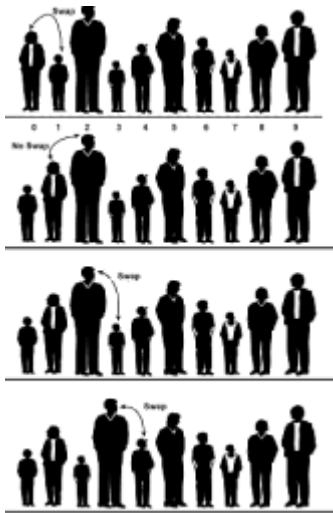

Figure 3.3: Bubble sort: beginning of first pass



Figure 3.4: Bubble sort: end of first pass

After this first pass through all the data, you've made $N-1$ comparisons and somewhere between 0 and $N-1$ swaps, depending on the initial arrangement of the players. The item at the end of the array is sorted and won't be moved again.

Now you go back and start another pass from the left end of the line. Again you go toward the right, comparing and swapping when appropriate. However, this time you can stop one player short of the end of the line, at position $N-2$, because you know the last position, at $N-1$, already contains the tallest player. This rule could be stated as:

4. When you reach the first sorted player, start over at the left end of the line.

You continue this process until all the players are in order. This is all much harder to describe than it is to demonstrate, so let's watch the bubbleSort Workshop applet at work.

The bubbleSort Workshop Applet

Start the bubbleSort Workshop applet. You'll see something that looks like a bar graph, with the bar heights randomly arranged, as shown in Figure 3.5.

The Run Button

This is a two-speed graph: you can either let it run by itself or you can single-step through the process. To get a quick idea of what happens, click the Run button. The algorithm will bubble sort the bars. When it finishes, in 10 seconds or so, the bars will be sorted, as

shown in Figure 3.6.

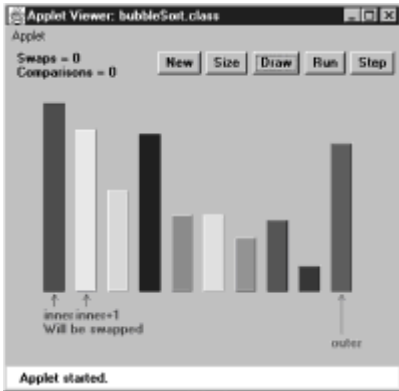

Figure 3.5: The bubbleSort Workshop applet

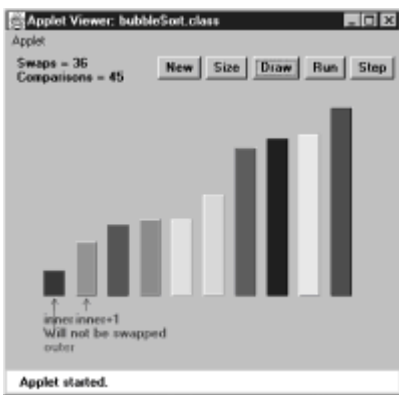

Figure 3.6: After the bubble sort

The New Button

To do another sort, press the New button. New creates a new set of bars and initializes the sorting routine. Repeated presses of New toggle between two arrangements of bars: a random order as shown in Figure 3.5, and an inverse ordering where the bars are sorted backward. This inverse ordering provides an extra challenge for many sorting algorithms.

The Step Button

The real payoff for using the bubbleSort Workshop applet comes when you single-step through a sort. You'll be able to see exactly how the algorithm carries out each step.

Start by creating a new randomly arranged graph with New. You'll see three arrows pointing at different bars. Two arrows, labeled `inner` and `inner+1`, are side-by-side on the left. Another arrow, `outer`, starts on the far right. (The names are chosen to correspond to the inner and outer loop variables in the nested loops used in the algorithm.)

Click once on the Step button. You'll see the `inner` and the `inner+1` arrows move together one position to the right, swapping the bars if it's appropriate. These arrows correspond to the two players you compared, and possibly swapped, in the baseball scenario.

A message under the arrows tells you whether the contents of `inner` and `inner+1` will be swapped, but you know this just from comparing the bars: if the taller one is on the left, they'll be swapped. Messages at the top of the graph tell you how many swaps and comparisons have been carried out so far. (A complete sort of 10 bars requires 45 comparisons and, on the average, about 22 swaps.)

Continue pressing Step. Each time `inner` and `inner+1` finish going all the way from 0 to `outer`, the `outer` pointer moves one position to the left. At all times during the sorting process, all the bars to the right of `outer` are sorted; those to the left of (and at) `outer` are not.

The Size Button

The Size button toggles between 10 bars and 100 bars. Figure 3.7 shows what the 100 random bars look like.

You probably don't want to single-step through the sorting process for 100 bars unless you're unusually patient. Press Run instead, and watch how the blue `inner` and `inner+1` pointers seem to find the tallest unsorted bar and carry it down the row to the right, inserting it just to the left of the sorted bars.

[Figure 3.8](#) shows the situation partway through the sorting process. The bars to the right of the red (longest) arrow are sorted. The bars to the left are beginning to look sorted, but much work remains to be done.

If you started a sort with Run and the arrows are whizzing around, you can freeze the process at any point by pressing the Step button. You can then single-step to watch the details of the operation, or press Run again to return to high-speed mode.

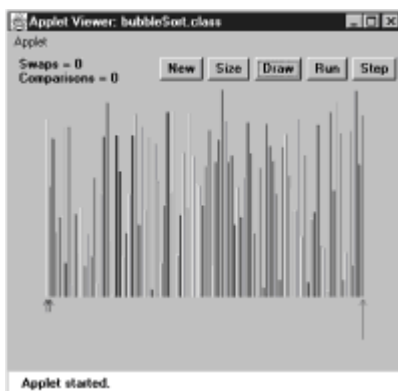

Figure 3.7: The bubbleSort applet with 100 bars



Figure 3.8: 100 partly sorted bars

The Draw Button

Sometimes while running the sorting algorithm at full speed, the computer takes time off to perform some other task. This can result in some bars not being drawn. If this happens, you can press the Draw button to redraw all the bars. Doing so pauses the run, so you'll need to press the Run button again to continue.

You can press Draw at any time there seems to be a glitch in the display.

Java Code for a Bubble Sort

In the `bubbleSort.java` program, shown in Listing 3.1, a class called `ArrayBub` encapsulates an array `a[]`, which holds variables of type `double`.

In a more serious program, the data would probably consist of objects, but we use a primitive type for simplicity. (We'll see how objects are sorted in the `objectSort.java` program in the last section of this chapter.) Also, to reduce the size of the listing, we don't show `find()` and `delete()` methods with the `ArrayBub` class, although they would normally be part of a such a class.

Listing 3.1 The `bubbleSort.java` Program

```
// bubbleSort.java
// demonstrates bubble sort
// to run this program: C>java BubbleSortApp
//-----
-
class ArrayBub
{
    private double[] a;           // ref to array a
    private int nElems;          // number of data items

//-----
-
    public ArrayBub(int max)      // constructor
    {
        a = new double[max];     // create the array
        nElems = 0;              // no items yet
    }

//-----
-
    public void insert(double value) // put element into array
    {
        a[nElems] = value;       // insert it
        nElems++;                // increment size
    }

//-----
-
    public void display()         // displays array contents
    {
```

```

        for(int j=0; j<nElems; j++)          // for each element,
            System.out.print(a[j] + " "); // display it
        System.out.println("");
    }

//-----
-
    public void bubbleSort()
    {
        int out, in;
        for(out=nElems-1; out>1; out--) // outer loop
(backward)
            for(in=0; in<out; in++) // inner loop (forward)
                if( a[in] > a[in+1] ) // out of order?
                    swap(in, in+1); // swap them
    } // end bubbleSort()

//-----
-
    private void swap(int one, int two)
    {
        double temp = a[one];
        a[one] = a[two];
        a[two] = temp;
    }

//-----
-
    } // end class ArrayBub

////////////////////////////////////
class BubbleSortApp
{
    public static void main(String[] args)
    {
        int maxSize = 100; // array size
        ArrayBub arr; // reference to array
        arr = new ArrayBub(maxSize); // create the array
        arr.insert(77); // insert 10 items
        arr.insert(99);
        arr.insert(44);
        arr.insert(55);
        arr.insert(22);
        arr.insert(88);
        arr.insert(11);
        arr.insert(00);
        arr.insert(66);
        arr.insert(33);

        arr.display(); // display items

        arr.bubbleSort(); // bubble sort them

        arr.display(); // display them again
    }
}

```

```

        } // end main()

    } // end class BubbleSortApp

```

The constructor and the `insert()` and `display()` methods of this class are similar to those we've seen before. However, there's a new method: `bubbleSort()`. When this method is invoked from `main()`, the contents of the array are rearranged into sorted order.

The `main()` routine inserts 10 items into the array in random order, displays the array, calls `bubbleSort()` to sort it, and then displays it again. Here's the output:

```

77 99 44 55 22 88 11 0 66 33
0 11 22 33 44 55 66 77 88 99

```

The `bubbleSort()` method is only four lines long. Here it is, extracted from the listing:

```

public void bubbleSort()
{
    int out, in;

    for(out=nElems-1; out>1; out--) // outer loop (backward)
        for(in=0; in<out; in++) // inner loop (forward)
            if( a[in] > a[in+1] ) // out of order?
                swap(in, in+1); // swap them
} // end bubbleSort()

```

The idea is to put the smallest item at the beginning of the array (index 0) and the largest item at the end (index `nElems-1`). The loop counter `out` in the outer `for` loop starts at the end of the array, at `nElems-1`, and decrements itself each time through the loop. The items at indices greater than `out` are always completely sorted. The `out` variable moves left after each pass by `in` so that items that are already sorted are no longer involved in the algorithm.

The inner loop counter `in` starts at the beginning of the array and increments itself each cycle of the inner loop, exiting when it reaches `out`. Within the inner loop, the two array cells pointed to by `in` and `in+1` are compared and swapped if the one in `in` is larger than the one in `in+1`.

For clarity, we use a separate `swap()` method to carry out the swap. It simply exchanges the two values in the two array cells, using a temporary variable to hold the value of the first cell while the first cell takes on the value in the second, then setting the second cell to the temporary value. Actually, using a separate `swap()` method may not be a good idea in practice, because the function call adds a small amount of overhead. If you're writing your own sorting routine, you may prefer to put the swap instructions in line to gain a slight increase in speed.

Invariants

In many algorithms there are conditions that remain unchanged as the algorithm proceeds. These conditions are called *invariants*. Recognizing invariants can be useful in understanding the algorithm. In certain situations they may also be helpful in debugging; you can repeatedly check that the invariant is true, and signal an error if it isn't.

In the `bubbleSort.java` program, the invariant is that the data items to the right of `outer` are sorted. This remains true throughout the running of the algorithm. (On the first

pass, nothing has been sorted yet, and there are no items to the right of `outer` because it starts on the rightmost element.)

Efficiency of the Bubble Sort

As you can see by watching the Workshop applet with 10 bars, the `inner` and `inner+1` arrows make 9 comparisons on the first pass, 8 on the second, and so on, down to 1 comparison on the last pass. For 10 items this is

$$9 + 8 + 7 + 6 + 5 + 4 + 3 + 2 + 1 = 45$$

In general, where N is the number of items in the array, there are $N-1$ comparisons on the first pass, $N-2$ on the second, and so on. The formula for the sum of such a series is

$$(N-1) + (N-2) + (N-3) + \dots + 1 = N*(N-1)/2$$

$N*(N-1)/2$ is 45 when N is 10.

Thus the algorithm makes about $N^2/2$ comparisons (ignoring the -1 , which doesn't make much difference, especially if N is large).

There are fewer swaps than there are comparisons, because two bars are swapped only if they need to be. If the data is random, a swap is necessary about half the time, so there will be about $N^2/4$ swaps. (Although in the worst case, with the initial data inversely sorted, a swap is necessary with every comparison.)

Both swaps and comparisons are proportional to N^2 . Because constants don't count in Big O notation, we can ignore the 2 and the 4 and say that the bubble sort runs in $O(N^2)$ time. This is slow, as you can verify by running the Workshop applet with 100 bars.

Whenever you see nested loops such as those in the bubble sort and the other sorting algorithms in this chapter, you can suspect that an algorithm runs in $O(N^2)$ time. The outer loop executes N times, and the inner loop executes N (or perhaps N divided by some constant) times for each cycle of the outer loop. This means you're doing something approximately $N*N$ or N^2 times.

Selection Sort

The selection sort improves on the bubble sort by reducing the number of swaps necessary from $O(N^2)$ to $O(N)$. Unfortunately, the number of comparisons remains $O(N^2)$. However, the selection sort can still offer a significant improvement for large records that must be physically moved around in memory, causing the swap time to be much more important than the comparison time. (Typically this isn't the case in Java, where references are moved around, not entire objects.)

Selection sort on the Baseball Players

Let's consider the baseball players again. In the selection sort, you can no longer compare only players standing next to each other. Thus you'll need to remember a certain player's height; you can use a notebook to write it down. A magenta-colored towel will also come in handy.

A Brief Description

What's involved is making a pass through all the players and picking (or *selecting*, hence the name of the sort) the shortest one. This shortest player is then swapped with the

player on the left end of the line, at position 0. Now the leftmost player is sorted, and won't need to be moved again. Notice that in this algorithm the sorted players accumulate on the left (lower indices), while in the bubble sort they accumulated on the right.

The next time you pass down the row of players, you start at position 1, and, finding the minimum, swap with position 1. This continues until all the players are sorted.

A More Detailed Description

In more detail, start at the left end of the line of players. Record the leftmost player's height in your notebook and throw the magenta towel on the ground in front of this person. Then compare the height of the next player to the right with the height in your notebook. If this player is shorter, cross out the height of the first player, and record the second player's height instead. Also move the towel, placing it in front of this new "shortest" (for the time being) player. Continue down the row, comparing each player with the minimum. Change the minimum value in your notebook, and move the towel, whenever you find a shorter player. When you're done, the magenta towel will be in front of the shortest player.

Swap this shortest player with the player on the left end of the line. You've now sorted one player. You've made $N-1$ comparisons, but only one swap.

On the next pass, you do exactly the same thing, except that you can completely ignore the player on the left, because this player has already been sorted. Thus the algorithm starts the second pass at position 1 instead of 0. With each succeeding pass, one more player is sorted and placed on the left, and one less player needs to be considered when finding the new minimum. [Figure 3.9](#) shows how this looks for the first three passes.

The selectSort Workshop Applet

To see how the selection sort looks in action, try out the selectSort Workshop applet. The buttons operate the same way as those in the bubbleSort applet. Use New to create a new array of 10 randomly arranged bars. The red arrow called `outer` starts on the left; it points to the leftmost unsorted bar. Gradually it will move right as more bars are added to the sorted group on its left.

The magenta `min` arrow also starts out pointing to the leftmost bar; it will move to record the shortest bar found so far. (The magenta `min` arrow corresponds to the towel in the baseball analogy.) The blue `inner` arrow marks the bar currently being compared with the minimum.

As you repeatedly press Step, `inner` moves from left to right, examining each bar in turn and comparing it with the bar pointed to by `min`. If the `inner` bar is shorter, `min` jumps over to this new, shorter bar. When `inner` reaches the right end of the graph, `min` points to the shortest of the unsorted bars. This bar is then swapped with `outer`, the leftmost unsorted bar.

[Figure 3.10](#) shows the situation midway through a sort. The bars to the left of `outer` are sorted, and `inner` has scanned from `outer` to the right end, looking for the shortest bar. The `min` arrow has recorded the position of this bar, which will be swapped with `outer`.

Use the Size button to switch to 100 bars, and sort a random arrangement. You'll see how the magenta `min` arrow hangs out with a perspective minimum value for a while, and then jumps to a new one when the blue `inner` arrow finds a smaller candidate. The red `outer` arrow moves slowly but inexorably to the right, as the sorted bars accumulate to its left.

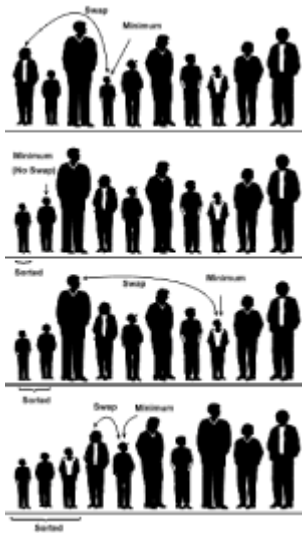

Figure 3.9: Selection sort on baseball players

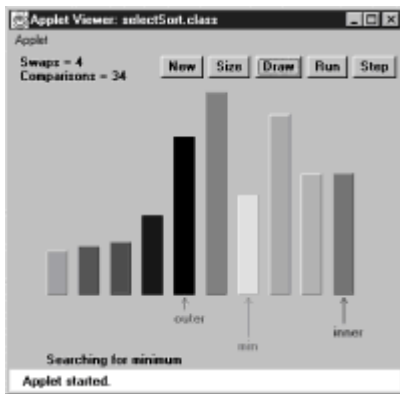

Figure 3.10: The selectSort Workshop appletred

Java Code for Selection Sort

The listing for the `selectSort.java` program is similar to that for `bubbleSort.java`, except that the container class is called `ArraySel` instead of `ArrayBub`, and the `bubbleSort()` method has been replaced by `selectSort()`. Here's how this method looks:

```
public void selectionSort()
{
    int out, in, min;

    for(out=0; out<nElems-1; out++)    // outer loop
    {
        min = out;                    // minimum
        for(in=out+1; in<nElems; in++) // inner loop
            if(a[in] < a[min] )       // if min greater,
                min = in;             // we have a new min
        swap(out, min);               // swap them
    } // end for(outer)
} // end selectionSort()
```

The outer loop, with loop variable `out`, starts at the beginning of the array (index 0) and proceeds toward higher indices. The inner loop, with loop variable `in`, begins at `out` and likewise proceeds to the right.

At each new position of `in`, the elements `a[in]` and `a[min]` are compared. If `a[in]` is smaller, then `min` is given the value of `in`. At the end of the inner loop, `min` points to the minimum value, and the array elements pointed to by `out` and `min` are swapped. Listing 3.2 shows the complete `selectSort.java` program.

Listing 3.2 The `selectSort.java` Program

```
// selectSort.java
// demonstrates selection sort
// to run this program: C>java SelectSortApp
//-----
-
class ArraySel
{
    private double[] a;           // ref to array a
    private int nElems;          // number of data items

//-----
-
    public ArraySel(int max)      // constructor
    {
        a = new double[max];     // create the array
        nElems = 0;              // no items yet
    }

//-----
-
    public void insert(double value) // put element into array
    {
        a[nElems] = value;       // insert it
        nElems++;                // increment size
    }

//-----
-
    public void display()         // displays array contents
    {
        for(int j=0; j<nElems; j++) // for each element,
            System.out.print(a[j] + " "); // display it
        System.out.println("");
    }

//-----
-
    public void selectionSort()
    {
        int out, in, min;

        for(out=0; out<nElems-1; out++) // outer loop
        {
```

```

        min = out;                // minimum
        for(in=out+1; in<nElems; in++) // inner loop
            if(a[in] < a[min] )      // if min greater,
                min = in;           // we have a new min
        swap(out, min);            // swap them
    } // end for(outer)
} // end selectionSort()

//-----
-
private void swap(int one, int two)
{
    double temp = a[one];
    a[one] = a[two];
    a[two] = temp;
}

//-----
-
} // end class ArraySel

////////////////////////////////////

class SelectSortApp
{
    public static void main(String[] args)
    {
        int maxSize = 100;        // array size
        ArraySel arr;            // reference to array
        arr = new ArraySel(maxSize); // create the array

        arr.insert(77);          // insert 10 items
        arr.insert(99);
        arr.insert(44);
        arr.insert(55);
        arr.insert(22);
        arr.insert(88);
        arr.insert(11);
        arr.insert(00);
        arr.insert(66);
        arr.insert(33);

        arr.display();           // display items

        arr.selectionSort();     // selection-sort them

        arr.display();           // display them again
    } // end main()
} // end class SelectSortApp

//-----
-

```

The output from `selectSort.java` is identical to that from `bubbleSort.java`:

```
77 99 44 55 22 88 11 0 66 33
0 11 22 33 44 55 66 77 88 99
```

Invariant

In the `selectSort.java` program, the data items with indices less than or equal to `outer` are always sorted.

Efficiency of the Selection Sort

The selection sort performs the same number of comparisons as the bubble sort: $N*(N-1)/2$. For 10 data items, this is 45 comparisons. However, 10 items require fewer than 10 swaps. With 100 items, 4,950 comparisons are required, but fewer than 100 swaps. For large values of N , the comparison times will dominate, so we would have to say that the selection sort runs in $O(N^2)$ time, just as the bubble sort did. However, it is unquestionably faster because there are so few swaps. For smaller values of N , it may in fact be considerably faster, especially if the swap times are much larger than the comparison times.

Insertion Sort

In most cases the insertion sort is the best of the elementary sorts described in this chapter. It still executes in $O(N^2)$ time, but it's about twice as fast as the bubble sort and somewhat faster than the selection sort in normal situations. It's also not too complex, although it's slightly more involved than the bubble and selection sorts. It's often used as the final stage of more sophisticated sorts, such as quicksort.

Insertion sort on the Baseball Players

Start with your baseball players lined up in random order. (They wanted to play a game, but clearly there's no time for that.) It's easier to think about the insertion sort if we begin in the middle of the process, when the team is half sorted.

Partial Sorting

At this point there's an imaginary marker somewhere in the middle of the line. (Maybe you throw a red T-shirt on the ground in front of a player.) The players to the left of this marker are *partially sorted*. This means that they are sorted among themselves; each one is taller than the person to his left. However, they aren't necessarily in their final positions, because they may still need to be moved when previously unsorted players are inserted between them.

Note that partial sorting did not take place in the bubble sort and selection sort. In these algorithms a group of data items was completely sorted at any given time; in the insertion sort a group of items is only partially sorted.

The Marked Player

The player where the marker is, whom we'll call the "marked" player, and all the players on her right, are as yet unsorted. This is shown in Figure 3.11.a.

What we're going to do is insert the marked player in the appropriate place in the (partially) sorted group. However, to do this, we'll need to shift some of the sorted players to the right to make room. To provide a space for this shift, we take the marked player out of line. (In the program this data item is stored in a temporary variable.) This is shown in

Figure 3.11.b.

Now we shift the sorted players to make room. The tallest sorted player moves into the marked player's spot, the next-tallest player into the tallest player's spot, and so on.

When does this shifting process stop? Imagine that you and the marked player are walking down the line to the left. At each position you shift another player to the right, but you also compare the marked player with the player about to be shifted. The shifting process stops when you've shifted the last player that's taller than the marked player. The last shift opens up the space where the marked player, when inserted, will be in sorted order. This is shown in Figure 3.11.c.



Figure 3.11: The insertion sort on baseball players

Now the partially sorted group is one player bigger, and the unsorted group is one player smaller. The marker T-shirt is moved one space to the right, so it's again in front of the leftmost unsorted player. This process is repeated until all the unsorted players have been inserted (hence the name *insertion* sort) into the appropriate place in the partially sorted group.

The insertSort Workshop Applet

Use the insertSort Workshop applet to demonstrate the insertion sort. Unlike the other sorting applets, it's probably more instructive to begin with 100 random bars rather than 10.

Sorting 100 Bars

Change to 100 bars with the Size button, and click Run to watch the bars sort themselves before your very eyes. You'll see that the short red `outer` arrow marks the dividing line between the partially sorted bars to the left and the unsorted bars to the right. The blue `inner` arrow keeps starting from `outer` and zipping to the left, looking for the proper place to insert the marked bar. Figure 3.12 shows how this looks when about half the bars are partially sorted.

The marked bar is stored in the temporary variable pointed to by the magenta arrow at the right end of the graph, but the contents of this variable are replaced so often it's hard to see what's there (unless you slow down to single-step mode).

Sorting 10 Bars

To get down to the details, use `Size` to switch to 10 bars. (If necessary, use `New` to make sure they're in random order.)

At the beginning, `inner` and `outer` point to the second bar from the left (array index 1), and the first message is `Will copy outer to temp`. This will make room for the shift. (There's no arrow for `inner-1`, but of course it's always one bar to the left of `inner`.)

Click the `Step` button. The bar at `outer` will be copied to `temp`. A copy means that there are now two bars with the same height and color shown on the graph. This is slightly misleading, because in a real Java program there are actually two references pointing to the same object, not two identical objects. However, showing two identical bars is meant to convey the idea of copying the reference.

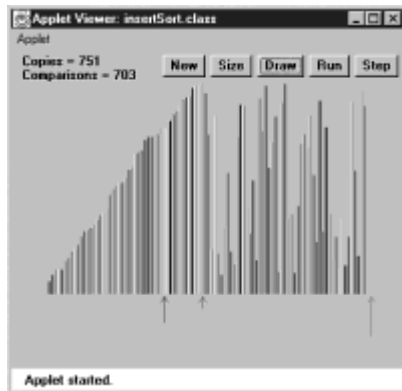

Figure 3.12: The `insertSort` Workshop applet with 100 bars

What happens next depends on whether the first two bars are already in order (smaller on the left). If they are, you'll see `Have compared inner-1 and temp`, no copy necessary.

If the first two bars are not in order, the message is `Have compared inner-1 and temp`, `will copy inner-1 to inner`. This is the shift that's necessary to make room for the value in `temp` to be reinserted. There's only one such shift on this first pass; more shifts will be necessary on subsequent passes. The situation is shown in Figure 3.1.

On the next click, you'll see the copy take place from `inner-1` to `inner`. Also, the `inner` arrow moves one space left. The new message is `Now inner is 0`, so no copy necessary. The shifting process is complete.

No matter which of the first two bars was shorter, the next click will show you `Will copy temp to inner`. This will happen, but if the first two bars were initially in order, you won't be able to tell a copy was performed, because `temp` and `inner` hold the same bar. Copying data over the top of the same data may seem inefficient, but the algorithm runs faster if it doesn't check for this possibility, which happens comparatively infrequently.

Now the first two bars are partially sorted (sorted with respect to each other), and the `outer` arrow moves one space right, to the third bar (index 2). The process repeats, with the `Will copy outer to temp` message. On this pass through the sorted data, there may be no shifts, one shift, or two shifts, depending on where the third bar fits among the first two.

Continue to single-step the sorting process. Again, it's easier to see what's happening after the process has run long enough to provide some sorted bars on the left. Then you can see how just enough shifts take place to make room for the reinsertion of the bar

from `temp` into its proper place.

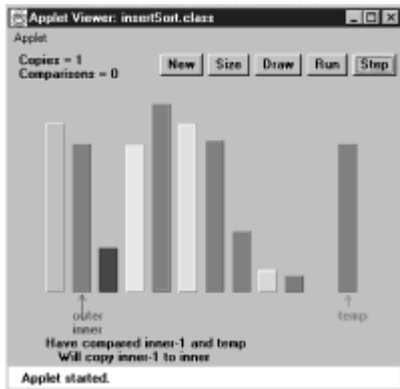

Figure 3.13: The insertSort Workshop applet with 10 bars

Java Code for Insertion Sort

Here's the method that carries out the insertion sort, extracted from the `insertSort.java` program:

```
public void insertionSort()
{
    int in, out;

    for(out=1; out<nElems; out++)    // out is dividing line
    {
        double temp = a[out];        // remove marked item
        in = out;                    // start shifts at out
        while(in>0 && a[in-1] >= temp) // until one is smaller,
        {
            a[in] = a[in-1];        // shift item right,
            --in;                    // go left one position
        }
        a[in] = temp;                // insert marked item
    } // end for

} // end insertionSort()
```

In the outer `for` loop, `out` starts at 1 and moves right. It marks the leftmost unsorted data. In the inner `while` loop, `in` starts at `out` and moves left, until either `temp` is smaller than the array element there, or it can't go left any further. Each pass through the `while` loop shifts another sorted element one space right.

It may be hard to see the relation between the steps in the Workshop applet and the code, so [Figure 3.14](#) is a flow diagram of the `insertionSort()` method, with the corresponding messages from the insertSort Workshop applet. Listing 3.3 shows the complete `insertSort.java` program.

Listing 3.3 The insertSort.java Program

```
// insertSort.java
// demonstrates insertion sort
```



```

// to run this program: C>java InsertSortApp
//-----
-
class ArrayIns
{
    private double[] a;           // ref to array a
    private int nElems;          // number of data items

//-----
-
    public ArrayIns(int max)      // constructor
    {
        a = new double[max];     // create the array
        nElems = 0;              // no items yet
    }

//-----
-
    public void insert(double value) // put element into array
    {
        a[nElems] = value;       // insert it
        nElems++;                // increment size
    }

//-----
-
    public void display()         // displays array contents
    {
        for(int j=0; j<nElems; j++) // for each element,
            System.out.print(a[j] + " "); // display it
        System.out.println("");
    }

//-----
-
    public void insertionSort()
    {
        int in, out;

        for(out=1; out<nElems; out++) // out is dividing line
        {
            double temp = a[out];     // remove marked item
            in = out;                 // start shifts at out
            while(in>0 && a[in-1] >= temp) // until one is
smaller,
            {
                a[in] = a[in-1];     // shift item right,
                --in;                 // go left one position
            }
            a[in] = temp;             // insert marked item
        } // end for
    } // end insertionSort()

//-----
-

```

```

    } // end class ArrayIns

////////////////////////////////////

class InsertSortApp
{
    public static void main(String[] args)
    {
        int maxSize = 100;           // array size
        ArrayIns arr;                // reference to array
        arr = new ArrayIns(maxSize); // create the array

        arr.insert(77);              // insert 10 items
        arr.insert(99);
        arr.insert(44);
        arr.insert(55);
        arr.insert(22);
        arr.insert(88);
        arr.insert(11);
        arr.insert(00);
        arr.insert(66);
        arr.insert(33);

        arr.display();              // display items

        arr.insertionSort();        // insertion-sort them

        arr.display();              // display them again
    } // end main()
} // end class InsertSortApp

```

Here's the output from the `insertSort.java` program; it's the same as that from the other programs in this chapter:

```

77 99 44 55 22 88 11 0 66 33
0 11 22 33 44 55 66 77 88 99

```

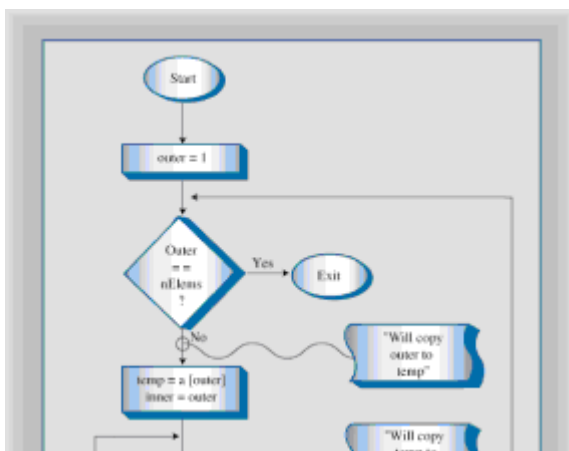

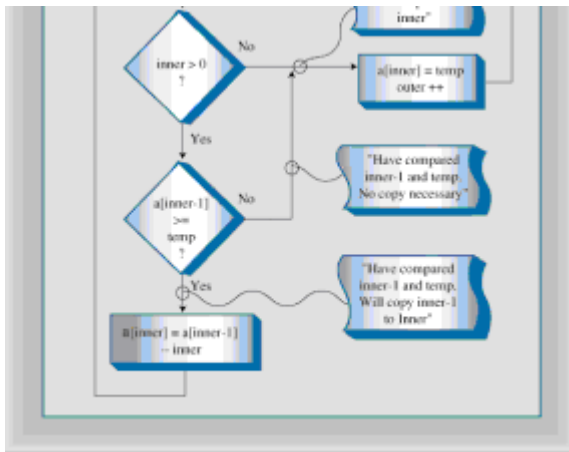

Figure 3.14: Flow diagram for `insertSort()`

Invariants in the Insertion Sort

At the end of each pass, following the insertion of the item from `temp`, the data items with smaller indices than `outer` are partially sorted.

Efficiency of the Insertion Sort

How many comparisons and copies does this algorithm require? On the first pass, it compares a maximum of one item. On the second pass, it's a maximum of two items, and so on, up to a maximum of $N-1$ comparisons on the last pass. This is

$$1 + 2 + 3 + \dots + N-1 = N*(N-1)/2$$

However, because on each pass an average of only half of the maximum number of items are actually compared before the insertion point is found, we can divide by 2, which gives:

$$N*(N-1)/4$$

The number of copies is approximately the same as the number of comparisons. However, a copy isn't as time-consuming as a swap, so for random data this algorithm runs twice as fast as the bubble sort and faster than the selection sort.

In any case, like the other sort routines in this chapter, the insertion sort runs in $O(N^2)$ time for random data.

For data that is already sorted or almost sorted, the insertion sort does much better. When data is in order, the condition in the `while` loop is never true, so it becomes a simple statement in the outer loop, which executes $N-1$ times. In this case the algorithm runs in $O(N)$ time. If the data is almost sorted, insertion sort runs in almost $O(N)$ time, which makes it a simple and efficient way to order a file that is only slightly out of order.

However, for data arranged in inverse sorted order, every possible comparison and shift is carried out, so the insertion sort runs no faster than the bubble sort. You can check this using the reverse-sorted data option (toggled with `New`) in the `insertSort` Workshop applet.

Sorting Objects

For simplicity we've applied the sorting algorithms we've looked at thus far to a primitive

data type: double. However, sorting routines will more likely be applied to objects than primitive types. Accordingly, we show a Java program, `objectSort.java`, that sorts an array of `Person` objects (last seen in the `classDataArray.java` program in [Chapter 2](#)).

Java Code for Sorting Objects

The algorithm used is the insertion sort from the last section. The `Person` objects are sorted on `lastName`; this is the key field. The `objectSort.java` program is shown in Listing 3.4.

Listing 3.4 The `objectSort.java` Program

```
// objectSort.java
// demonstrates sorting objects (uses insertion sort)
// to run this program: C>java ObjectSortApp
////////////////////////////////////
class Person
{
    private String lastName;
    private String firstName;
    private int age;

    //-----
-   public Person(String last, String first, int a)
        {                               // constructor
            lastName = last;
            firstName = first;
            age = a;
        }

    //-----
-   public void displayPerson()
        {
            System.out.print("  Last name: " + lastName);
            System.out.print(", First name: " + firstName);
            System.out.println(", Age: " + age);
        }

    //-----
-   public String getLast()             // get last name
        { return lastName; }
    } // end class Person

////////////////////////////////////

class ArrayInOb
{
    private Person[] a;                 // ref to array a
    private int nElems;                 // number of data items
```

```

//-----
-
    public ArrayInOb(int max)          // constructor
    {
        a = new Person[max];          // create the array
        nElems = 0;                   // no items yet
    }

//-----
-
                                // put person into array
    public void insert(String last, String first, int age)
    {
        a[nElems] = new Person(last, first, age);
        nElems++;                      // increment size
    }

//-----
-
    public void display()             // displays array contents
    {
        for(int j=0; j<nElems; j++)    // for each element,
            a[j].displayPerson();      // display it
        System.out.println("");
    }

//-----
-
    public void insertionSort()
    {
        int in, out;

        for(out=1; out<nElems; out++)  // out is dividing line
        {
            Person temp = a[out];      // remove marked person
            in = out;                   // start shifting at out

            while(in>0 &&                // until smaller one
found,                a[in-1].getLast().compareTo(temp.getLast())>0)
            {
                a[in] = a[in-1];       // shift item to the right
                --in;                   // go left one position
            }
            a[in] = temp;               // insert marked item
        } // end for
    } // end insertionSort()

//-----
-
    } // end class ArrayInOb

////////////////////////////////////

```

```

class ObjectSortApp
{
public static void main(String[] args)
{
    int maxSize = 100;           // array size
    ArrayInOb arr;              // reference to array
    arr = new ArrayInOb(maxSize); // create the array

    arr.insert("Evans", "Patty", 24);
    arr.insert("Smith", "Doc", 59);
    arr.insert("Smith", "Lorraine", 37);
    arr.insert("Smith", "Paul", 37);
    arr.insert("Yee", "Tom", 43);
    arr.insert("Hashimoto", "Sato", 21);
    arr.insert("Stimson", "Henry", 29);
    arr.insert("Velasquez", "Jose", 72);
    arr.insert("Vang", "Minh", 22);
    arr.insert("Creswell", "Lucinda", 18);

    System.out.println("Before sorting:");
    arr.display();           // display items

    arr.insertionSort();    // insertion-sort them

    System.out.println("After sorting:");
    arr.display();          // display them again
} // end main()
} // end class ObjectSortApp

```

Here's the output of this program:

Before sorting:

```

Last name: Evans, First name: Patty, Age: 24
Last name: Smith, First name: Doc, Age: 59
Last name: Smith, First name: Lorraine, Age: 37
Last name: Smith, First name: Paul, Age: 37
Last name: Yee, First name: Tom, Age: 43
Last name: Hashimoto, First name: Sato, Age: 21
Last name: Stimson, First name: Henry, Age: 29
Last name: Velasquez, First name: Jose, Age: 72
Last name: Vang, First name: Minh, Age: 22
Last name: Creswell, First name: Lucinda, Age: 18

```

After sorting:

```

Last name: Creswell, First name: Lucinda, Age: 18
Last name: Evans, First name: Patty, Age: 24
Last name: Hashimoto, First name: Sato, Age: 21
Last name: Smith, First name: Doc, Age: 59
Last name: Smith, First name: Lorraine, Age: 37
Last name: Smith, First name: Paul, Age: 37
Last name: Stimson, First name: Henry, Age: 29
Last name: Vang, First name: Minh, Age: 22

```

```
Last name: Velasquez, First name: Jose, Age: 72
Last name: Yee, First name: Tom, Age: 43
```

Lexicographical Comparisons

The `insertionSort()` method is similar to that in `insertSort.java`, but it has been adapted to compare the `lastName` key values of records rather than the value of a primitive type.

We use the `compareTo()` method of the `String` class to perform the comparisons in the `insertionSort()` method. Here's the expression that uses it:

```
a[in-1].getLast().compareTo(temp.getLast()) > 0
```

The `compareTo()` method returns different integer values depending on the lexicographical (that is, alphabetical) ordering of the `String` for which it's invoked and the `String` passed to it as an argument, as shown in Table 3.1.

Table 3.1: Operation of the `compareTo()` method

<code>s2.compareTo(s1)</code>	Return Value
<code>s1 < s2</code>	< 0
<code>s1 equals s2</code>	0
<code>s1 > s2</code>	> 0

For example, if `s1` is "cat" and `s2` is "dog", the function will return a number less than 0. In the program this method is used to compare the last name of `a[in-1]` with the last name of `temp`.

Stability

Sometimes it matters what happens to data items that happen to have equal keys. For example, you may have employee data arranged alphabetically by last names. (That is, the last names were used as key values in the sort.) Now you want to sort the data by zip code, but you want all the items with the same zip code to continue to be sorted by last names. You want the algorithm to sort only what needs to be sorted, and leave everything else in its original order. Some sorting algorithms retain this secondary ordering; they're said to be *stable*.

All the algorithms in this chapter are stable. For example, notice the output of the `objectSort.java` program. There are three persons with the last name of Smith. Initially the order is Doc Smith, Lorraine Smith, and Paul Smith. After the sort, this ordering is preserved, despite the fact that the various Smith objects have been moved to new locations.

Comparing the Simple Sorts

There's probably no point in using the bubble sort unless you don't have your algorithm book handy. The bubble sort is so simple you can write it from memory. Even so, it's practical only if the amount of data is small. (For a discussion of what "small" means, see [Chapter 15, "When to Use What."](#))

The selection sort minimizes the number of swaps, but the number of comparisons is still high. It might be useful when the amount of data is small and swapping data items is very time-consuming compared with comparing them.

The insertion sort is the most versatile of the three and is the best bet in most situations, assuming the amount of data is small or the data is almost sorted. For larger amounts of data, quicksort is generally considered the fastest approach; we'll examine quicksort in [Chapter 7](#).

We've compared the sorting algorithms in terms of speed. Another consideration for any algorithm is how much memory space it needs. All three of the algorithms in this chapter carry out their sort *in place*, meaning that, beside the initial array, very little extra memory is required. All the sorts require an extra variable to store an item temporarily while it's being swapped.

You can recompile the example programs, such as `bubbleSort.java`, to sort larger amounts of data. By timing them for larger sorts, you can get an idea of the differences between them and how long it takes to sort different amounts of data on your particular system.

Summary

- The sorting algorithms in this chapter all assume an array as a data storage structure.
- Sorting involves comparing the keys of data items in the array and moving the items (actually references to the items) around until they're in sorted order.
- All the algorithms in this chapter execute in $O(N^2)$ time. Nevertheless, some can be substantially faster than others.
- An invariant is a condition that remains unchanged while an algorithm runs.

The bubble sort is the least efficient, but the simplest, sort.

- The insertion sort is the most commonly used of the $O(N^2)$ sorts described in this chapter.
- A sort is stable if the order of elements with the same key is retained.
- None of the sorts in this chapter require more than a single temporary variable in addition to the original array.

Part II

Chapter List

[Chapter 4:](#) [Stacks and Queues](#)

[Chapter](#) [Linked Lists](#)

[5:](#)

[Chapter](#) [Recursion](#)

[6:](#)

Chapter 4: Stacks and Queues

Overview

In this chapter we'll examine three data storage structures: the stack, the queue, and the priority queue. We'll begin by discussing how these structures differ from arrays; then we'll examine each one in turn. In the [last section](#), we'll look at an operation in which the stack plays a significant role: parsing arithmetic expressions.

A Different Kind of Structure

There are significant differences between the data structures and algorithms we've seen in previous chapters and those we'll look at now. We'll discuss three of these differences before we examine the new structures in detail.

Programmer's Tools

The array—the data storage structure we've been examining thus far—as well as many other structures we'll encounter later in this book (linked lists, trees, and so on), are appropriate for the kind of data you might find in a database application. They're typically used for personnel records, inventories, financial data, and so on; data that corresponds to real-world objects or activities. These structures facilitate access to data: they make it easy to insert, delete, and search for particular items.

The structures and algorithms we'll examine in this chapter, on the other hand, are more often used as programmer's tools. They're primarily conceptual aids rather than full-fledged data storage devices. Their lifetime is typically shorter than that of the database-type structures. They are created and used to carry out a particular task during the operation of a program; when the task is completed, they're discarded.

Restricted Access

In an array, any item can be accessed, either immediately—if its index number is known—or by searching through a sequence of cells until it's found. In the data structures in this chapter, however, access is restricted: only one item can be read or removed at a given time.

The interface of these structures is designed to enforce this restricted access. Access to other items is (in theory) not allowed.

More Abstract

Stacks, queues, and priority queues are more abstract entities than arrays and many other data storage structures. They're defined primarily by their interface: the permissible operations that can be carried out on them. The underlying mechanism used to implement them is typically not visible to their user.

For example, the underlying mechanism for a stack can be an array, as shown in this chapter, or it can be a linked list. The underlying mechanism for a priority queue can be an array or a special kind of tree called a *heap*. We'll return to the topic of one data structure being implemented by another when we discuss Abstract Data Types (ADTs) in [Chapter 5, "Linked Lists."](#)

Stacks

A stack allows access to only one data item: the last item inserted. If you remove this item, then you can access the next-to-last item inserted, and so on. This is a useful capability in many programming situations. In this section, we'll see how a stack can be used to check whether parentheses, braces, and brackets are balanced in a computer program source file. At the end of this chapter, we'll see a stack playing a vital role in parsing (analyzing) arithmetic expressions such as $3*(4+5)$.

A stack is also a handy aid for algorithms applied to certain complex data structures. In [Chapter 8, "Binary Trees,"](#) we'll see it used to help traverse the nodes of a tree. In [Chapter 13, "Graphs,"](#) we'll apply it to searching the vertices of a graph (a technique that can be used to find your way out of a maze).

Most microprocessors use a stack-based architecture. When a method is called, its return address and arguments are pushed onto a stack, and when it returns they're popped off. The stack operations are built into the microprocessor.

Some older pocket calculators used a stack-based architecture. Instead of entering arithmetic expressions using parentheses, you pushed intermediate results onto a stack. We'll learn more about this approach when we discuss parsing arithmetic expressions in the [last section](#) in this chapter.

The Postal Analogy

To understand the idea of a stack, consider an analogy provided by the U. S. Postal Service. Many people, when they get their mail, toss it onto a stack on the hall table or into an "in" basket at work. Then, when they have a spare moment, they process the accumulated mail from the top down. First they open the letter on the top of the stack and take appropriate action—paying the bill, throwing it away, or whatever. When the first letter has been disposed of, they examine the next letter down, which is now the top of the stack, and deal with that. Eventually they work their way down to the letter on the bottom of the stack (which is now the top). Figure 4.1 shows a stack of mail.

This "do the top one first" approach works all right as long as you can easily process all the mail in a reasonable time. If you can't, there's the danger that letters on the bottom of the stack won't be examined for months, and the bills they contain will become overdue.

Of course, many people don't rigorously follow this top-to-bottom approach. They may, for example, take the mail off the bottom of the stack, so as to process the oldest letter first. Or they might shuffle through the mail before they begin processing it and put higher-priority letters on top. In these cases, their mail system is no longer a stack in the computer-science sense of the word. If they take letters off the bottom, it's a queue; and if they prioritize it, it's a priority queue. We'll look at these possibilities later.

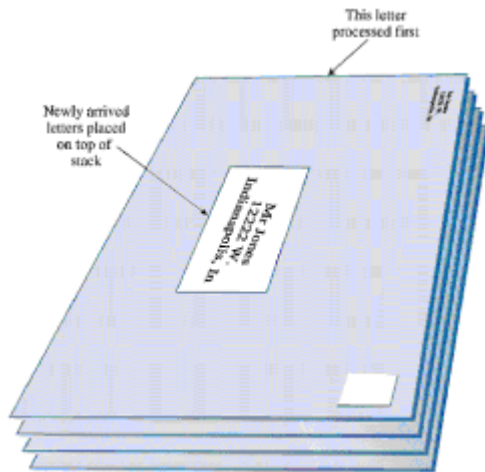

Figure 4.1: A stack of letters

Another stack analogy is the tasks you perform during a typical workday. You're busy on a long-term project (A), but you're interrupted by a coworker asking you for temporary help with another project (B). While you're working on B, someone in accounting stops by for a meeting about travel expenses (C), and during this meeting you get an emergency call from someone in sales and spend a few minutes troubleshooting a bulky product (D). When you're done with call D, you resume meeting C; when you're done with C, you resume project B, and when you're done with B you can (finally!) get back to project A. Lower priority projects are "stacked up" waiting for you to return to them.

Placing a data item on the top of the stack is called *pushing* it. Removing it from the top of the stack is called *poping* it. These are the primary stack operations. A stack is said to be a Last-In-First-Out (LIFO) storage mechanism, because the last item inserted is the first one to be removed.

The Stack Workshop Applet

Let's use the Stack Workshop applet to get an idea how stacks work. When you start up the applet, you'll see four buttons: New, Push, Pop, and Peek, as shown in Figure 4.2.

The Stack Workshop applet is based on an array, so you'll see an array of data items. Although it's based on an array, a stack restricts access, so you can't access it as you would an array. In fact, the concept of a stack and the underlying data structure used to implement it are quite separate. As we noted earlier, stacks can also be implemented by other kinds of storage structures, such as linked lists.

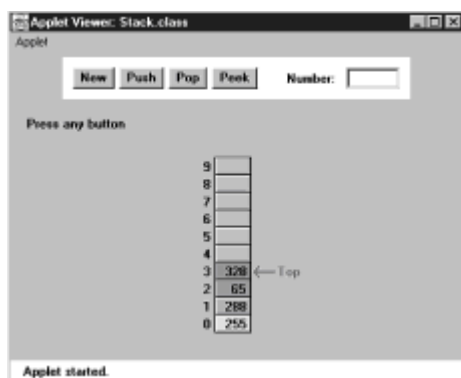

Figure 4.2: The Stack Workshop applet

New

The stack in the Workshop applet starts off with four data items already inserted. If you want to start with an empty stack, the New button creates a new stack with no items. The next three buttons carry out the significant stack operations.

Push

To insert a data item on the stack, use the button labeled Push. After the first press of this button, you'll be prompted to enter the key value of the item to be pushed. After typing it into the text field, a few more presses will insert the item on the top of the stack.

A red arrow always points to the top of the stack; that is, the last item inserted. Notice how, during the insertion process, one step (button press) increments (moves up) the Top arrow, and the next step actually inserts the data item into the cell. If you reversed the order, you'd overwrite the existing item at Top. When writing the code to implement a stack, it's important to keep in mind the order in which these two steps are executed.

If the stack is full and you try to push another item, you'll get the `Can't insert: stack is full` message. (Theoretically, an ADT stack doesn't become full, but the array implementing it does.)

Pop

To remove a data item from the top of the stack, use the Pop button. The value popped appears in the Number text field; this corresponds to a `pop()` routine returning a value.

Again, notice the two steps involved: first the item is removed from the cell pointed to by Top; then Top is decremented to point to the highest occupied cell. This is the reverse of the sequence used in the push operation.

The pop operation shows an item actually being removed from the array, and the cell color becoming gray to show the item has been removed. This is a bit misleading, in that deleted items actually remain in the array until written over by new data. However, they cannot be accessed once the Top marker drops below their position, so conceptually they are gone, as the applet shows.

When you've popped the last item off the stack, the Top arrow points to -1 , below the lowest cell. This indicates that the stack is empty. If the stack is empty and you try to pop an item, you'll get the `Can't pop: stack is empty` message.

Peek

Push and pop are the two primary stack operations. However, it's sometimes useful to be able to read the value from the top of the stack without removing it. The peek operation does this. By pushing the Peek button a few times, you'll see the value of the item at Top copied to the Number text field, but the item is not removed from the stack, which remains unchanged.

Notice that you can only peek at the top item. By design, all the other items are invisible to the stack user.

Stack Size

Stacks are typically small, temporary data structures, which is why we've shown a stack of only 10 cells. Of course, stacks in real programs may need a bit more room than this, but it's surprising how small a stack needs to be. A very long arithmetic expression, for

example, can be parsed with a stack of only a dozen or so cells.

Java Code for a Stack

Let's examine a program, `Stack.java`, that implements a stack using a class called `StackX`. Listing 4.1 contains this class and a short `main()` routine to exercise it.

Listing 4.1 The `Stack.java` Program

```
// Stack.java
// demonstrates stacks
// to run this program: C>java StackApp
import java.io.*;           // for I/O
////////////////////////////////////
class StackX
{
    private int maxSize;      // size of stack array
    private double[] stackArray;
    private int top;         // top of stack

//-----
-   public StackX(int s)      // constructor
    {
        maxSize = s;        // set array size
        stackArray = new double[maxSize]; // create array
        top = -1;           // no items yet
    }

//-----
-   public void push(double j) // put item on top of stack
    {
        stackArray[++top] = j; // increment top, insert item
    }

//-----
-   public double pop()      // take item from top of stack
    {
        return stackArray[top--]; // access item, decrement top
    }

//-----
-   public double peek()    // peek at top of stack
    {
        return stackArray[top];
    }

//-----
-   public boolean isEmpty() // true if stack is empty
    {
```

```

        return (top == -1);
    }

//-----
-
    public boolean isFull()    // true if stack is full
    {
        return (top == maxSize-1);
    }

//-----
-
    } // end class StackX

////////////////////////////////////

class StackApp
{
    public static void main(String[] args)
    {
        StackX theStack = new StackX(10); // make new stack
        theStack.push(20);                // push items onto stack
        theStack.push(40);
        theStack.push(60);
        theStack.push(80);

        while( !theStack.isEmpty() )     // until it's empty,
        {                                  // delete item from
stack
            double value = theStack.pop();
            System.out.print(value);      // display it
            System.out.print(" ");
        } // end while
        System.out.println("");
    } // end main()

} // end class StackApp

```

The `main()` method in the `StackApp` class creates a stack that can hold 10 items, pushes 4 items onto the stack, and then displays all the items by popping them off the stack until it's empty. Here's the output:

```
80 60 40 20
```

Notice how the order of the data is reversed. Because the last item pushed is the first one popped; the 80 appears first in the output.

This version of the `StackX` class holds data elements of type `double`. As noted in the [last chapter](#), you can change this to any other type, including object types.

StackX Class Methods

The constructor creates a new stack of a size specified in its argument. The fields of the stack comprise a variable to hold its maximum size (the size of the array), the array itself, and a variable `top`, which stores the index of the item on the top of the stack. (Note that

we need to specify a stack size only because the stack is implemented using an array. If it had been implemented using a linked list, for example, the size specification would be unnecessary.)

The `push()` method increments `top` so it points to the space just above the previous `top`, and stores a data item there. Notice that `top` is incremented before the item is inserted.

The `pop()` method returns the value at `top` and then decrements `top`. This effectively removes the item from the stack; it's inaccessible, although the value remains in the array (until another item is pushed into the cell).

The `peek()` method simply returns the value at `top`, without changing the stack.

The `isEmpty()` and `isFull()` methods return true if the stack is empty or full, respectively. The `top` variable is at `-1` if the stack is empty and `maxSize-1` if the stack is full.

Figure 4.3 shows how the stack class methods work.

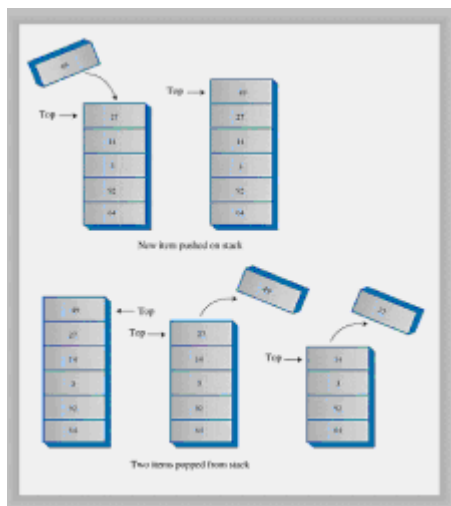

Figure 4.3: Operation of the `StackX` class methods

Error Handling

There are different philosophies about how to handle stack errors. What happens if you try to push an item onto a stack that's already full, or pop an item from a stack that's empty?

We've left the responsibility for handling such errors up to the class user. The user should always check to be sure the stack is not full before inserting an item:

```
if( !theStack.isFull() )
    insert(item);
else
    System.out.print("Can't insert, stack is full");
```

In the interest of simplicity, we've left this code out of the `main()` routine (and anyway, in this simple program, we know the stack isn't full because it has just been initialized). We do include the check for an empty stack when `main()` calls `pop()`.

Many stack classes check for these errors internally, in the `push()` and `pop()` methods. This is the preferred approach. In Java, a good solution for a stack class that discovers such errors is to throw an exception, which can then be caught and processed by the class user.

Stack Example 1: Reversing a Word

For our first example of using a stack, we'll examine a very simple task: reversing a word. When you run the program, it asks you to type in a word. When you press Enter, it displays the word with the letters in reverse order.

A stack is used to reverse the letters. First the characters are extracted one by one from the input string and pushed onto the stack. Then they're popped off the stack and displayed. Because of its last-in-first-out characteristic, the stack reverses the order of the characters. Listing 4.2 shows the code for the `reverse.java` program.

Listing 4.2 The `reverse.java` Program

```
// reverse.java
// stack used to reverse a string
// to run this program: C>java ReverseApp
import java.io.*;                // for I/O
////////////////////////////////////
class StackX
{
    private int maxSize;
    private char[] stackArray;
    private int top;

//-----
-
    public StackX(int max)        // constructor
    {
        maxSize = max;
        stackArray = new char[maxSize];
        top = -1;
    }

//-----
-
    public void push(char j)      // put item on top of stack
    {
        stackArray[++top] = j;
    }

//-----
-
    public char pop()             // take item from top of stack
    {
        return stackArray[top--];
    }

//-----
-
    public char peek()           // peek at top of stack
```



```

    {
    return stackArray[top];
    }

//-----
-
    public boolean isEmpty() // true if stack is empty
    {
    return (top == -1);
    }

//-----
-
    } // end class StackX

////////////////////////////////////

class Reverser
{
    private String input;           // input string
    private String output;         // output string

//-----
-
    public Reverser(String in)     // constructor
    { input = in; }

//-----
-
    public String doRev()          // reverse the string
    {
    int stackSize = input.length(); // get max stack size
    StackX theStack = new StackX(stackSize); // make stack

    for(int j=0; j<input.length(); j++)
    {
input    char ch = input.charAt(j); // get a char from
        theStack.push(ch);         // push it
    }
    output = "";
    while( !theStack.isEmpty() )
    {
        char ch = theStack.pop(); // pop a char,
        output = output + ch;     // append to output
    }
    return output;
    } // end doRev()

//-----
-
    } // end class Reverser

////////////////////////////////////

```

```

class ReverseApp
{
    public static void main(String[] args) throws IOException
    {
        String input, output;
        while(true)
        {
            System.out.print("Enter a string: ");
            System.out.flush();
            input = getString();          // read a string from
kbd
            if( input.equals("") )      // quit if [Enter]
                break;

            // make a Reverser
            Reverser theReverser = new Reverser(input);
            output = theReverser.doRev(); // use it
            System.out.println("Reversed: " + output);
        } // end while
    } // end main()

//-----
-
    public static String getString() throws IOException
    {
        InputStreamReader isr = new InputStreamReader(System.in);
        BufferedReader br = new BufferedReader(isr);
        String s = br.readLine();
        return s;
    }

//-----
-

} // end class ReverseApp

```

We've created a class `Reverser` to handle the reversing of the input string. Its key component is the method `doRev()`, which carries out the reversal, using a stack. The stack is created within `doRev()`, which sizes it according to the length of the input string.

In `main()` we get a string from the user, create a `Reverser` object with this string as an argument to the constructor, call this object's `doRev()` method, and display the return value, which is the reversed string. Here's some sample interaction with the program:

```

Enter a string: part
Reversed: trap
Enter a string:

```

Stack Example 2: Delimiter Matching

One common use for stacks is to parse certain kinds of text strings. Typically the strings are lines of code in a computer language, and the programs parsing them are compilers.

To give the flavor of what's involved, we'll show a program that checks the delimiters in a line of text typed by the user. This text doesn't need to be a line of real Java code

(although it could be) but it should use delimiters the same way Java does. The delimiters are the braces '{'and'}', brackets '['and']', and parentheses '('and')'. Each opening or left delimiter should be matched by a closing or right delimiter; that is, every '{' should be followed by a matching '}' and so on. Also, opening delimiters that occur later in the string should be closed before those occurring earlier. Examples:

```

c[d]           // correct
a{b[c]d}e     // correct
a{b(c)d}e     // not correct; } doesn't match (
a[b{c}d]e}    // not correct; nothing matches final }
a{b(c)        // not correct; Nothing matches opening {

```

Opening Delimiters on the Stack

The program works by reading characters from the string one at a time and placing opening delimiters, when it finds them, on a stack. When it reads a closing delimiter from the input, it pops the opening delimiter from the top of the stack and attempts to match it with the closing delimiter. If they're not the same type (there's an opening brace but a closing parenthesis, for example), then an error has occurred. Also, if there is no opening delimiter on the stack to match a closing one, or if a delimiter has not been matched, an error has occurred. A delimiter that hasn't been matched is discovered because it remains on the stack after all the characters in the string have been read.

Let's see what happens on the stack for a typical correct string:

```
a{b(c[d]e) f}
```

Table 4.1 shows how the stack looks as each character is read from this string. The stack contents are shown in the second column. The entries in this column show the stack contents, reading from the bottom of the stack on the left to the top on the right.

As it's read, each opening delimiter is placed on the stack. Each closing delimiter read from the input is matched with the opening delimiter popped from the top of the stack. If they form a pair, all is well. Nondelimiter characters are not inserted on the stack; they're ignored.

Table 4.1: Stack contents in delimiter matching

Character Read	Stack Contents
A	
{	{
B	{
({{
C	{{
[{{[

```

D      {(
]      {(
E      {(
)      {
F      {
}

```

This approach works because pairs of delimiters that are opened last should be closed first. This matches the last-in-first-out property of the stack.

Java Code for `brackets.java`

The code for the parsing program, `brackets.java`, is shown in Listing 4.3. We've placed `check()`, the method that does the parsing, in a class called `BracketChecker`.

Listing 4.3 The `brackets.java` Program

```

// brackets.java
// stacks used to check matching brackets
// to run this program: C>java BracketsApp
import java.io.*;                // for I/O
////////////////////////////////////
class StackX
{
    private int maxSize;
    private char[] stackArray;
    private int top;

//-----
-   public StackX(int s)        // constructor
    {
        maxSize = s;
        stackArray = new char[maxSize];
        top = -1;
    }

//-----
-   public void push(char j)   // put item on top of stack
    {
        stackArray[++top] = j;
    }

//-----
-

```

```

public char pop()          // take item from top of stack
{
    return stackArray[top--];
}

//-----
-
public char peek()        // peek at top of stack
{
    return stackArray[top];
}

//-----
-
public boolean isEmpty()  // true if stack is empty
{
    return (top == -1);
}

//-----
-
} // end class StackX

////////////////////////////////////

class BracketChecker
{
    private String input;          // input string

//-----
-
    public BracketChecker(String in) // constructor
        { input = in; }

//-----
-
    public void check()
    {
size      int stackSize = input.length(); // get max stack
          StackX theStack = new StackX(stackSize); // make stack

          for(int j=0; j<input.length(); j++) // get chars in turn
          {
              char ch = input.charAt(j); // get char
              switch(ch)
              {
                  case '{': // opening symbols
                  case '[':
                  case '(':
                      theStack.push(ch); // push them
                      break;

                  case '}': // closing symbols

```

```

        case ']':
        case ')':
            if( !theStack.isEmpty() )    // if stack not
empty,
                {
                    char chx = theStack.pop(); // pop and check
                    if( (ch=='}' && chx!='{') ||
                        (ch==']' && chx!='[') ||
                        (ch=='\n' && chx!='(') )
                        System.out.println("Error: "+ch+" at "+j);
                }
            else // prematurely empty
                System.out.println("Error: "+ch+" at "+j);
            break;
        default: // no action on other characters
            break;
    } // end switch
} // end for
// at this point, all characters have been processed
if( !theStack.isEmpty() )
    System.out.println("Error: missing right delimiter");
} // end check()

//-----
-
} // end class BracketChecker

////////////////////////////////////

class BracketsApp
{
    public static void main(String[] args) throws IOException
    {
        String input;
        while(true)
        {
            System.out.print(
                "Enter string containing delimiters: ");
            System.out.flush();
            input = getString(); // read a string from kbd
            if( input.equals("") ) // quit if [Enter]
                break;
                // make a BracketChecker
            BracketChecker theChecker = new BracketChecker(input);
            theChecker.check(); // check brackets
        } // end while
    } // end main()

//-----
-
    public static String getString() throws IOException
    {
        InputStreamReader isr = new InputStreamReader(System.in);

```

```

        BufferedReader br = new BufferedReader(isr);
        String s = br.readLine();
        return s;
    }

//-----
-

    } // end class BracketsApp

```

The `check()` routine makes use of the `StackX` class from the last program. Notice how easy it is to reuse this class. All the code you need is in one place. This is one of the payoffs for object-oriented programming.

The `main()` routine in the `BracketsApp` class repeatedly reads a line of text from the user, creates a `BracketChecker` object with this text string as an argument, and then calls the `check()` method for this `BracketChecker` object. If it finds any errors, the `check()` method displays them; otherwise, the syntax of the delimiters is correct.

If it can, the `check()` method reports the character number where it discovered the error (starting at 0 on the left), and the incorrect character it found there. For example, for the input string

```
a{b(c]d}e
```

the output from `check()` will be

```
Error: ] at 5
```

The Stack as a Conceptual Aid

Notice how convenient the stack is in the `brackets.java` program. You could have set up an array to do what the stack does, but you would have had to worry about keeping track of an index to the most recently added character, as well as other bookkeeping tasks. The stack is conceptually easier to use. By providing limited access to its contents, using the `push()` and `pop()` methods, the stack has made your program easier to understand and less error prone. (Carpenters will also tell you it's safer to use the right tool for the job.)

Efficiency of Stacks

Items can be both pushed and popped from the stack implemented in the `StackX` class in constant $O(1)$ time. That is, the time is not dependent on how many items are in the stack, and is therefore very quick. No comparisons or moves are necessary.

Queues

The word *queue* is British for *line* (the kind you wait in). In Britain, to "queue up" means to get in line. In computer science a queue is a data structure that is similar to a stack, except that in a queue the first item inserted is the first to be removed (FIFO), while in a stack, as we've seen, the last item inserted is the first to be removed (LIFO). A queue works like the line at the movies: the first person to join the rear of the line is the first person to reach the front of the line and buy a ticket. The last person to line up is the last person to buy a ticket (or—if the show is sold out—to fail to buy a ticket). Figure 4.4 shows how this looks.



Figure 4.4: A queue of people

Queues are used as a programmer's tool as stacks are. We'll see an example where a queue helps search a graph in [Chapter 13](#). They're also used to model real-world situations such as people waiting in line at a bank, airplanes waiting to take off, or data packets waiting to be transmitted over the Internet.

There are various queues quietly doing their job in your computer's (or the network's) operating system. There's a printer queue where print jobs wait for the printer to be available. A queue also stores keystroke data as you type at the keyboard. This way, if you're using a word processor but the computer is briefly doing something else when you hit a key, the keystroke won't be lost; it waits in the queue until the word processor has time to read it. Using a queue guarantees the keystrokes stay in order until they can be processed.

The Queue Workshop Applet

Start up the Queue Workshop applet. You'll see a queue with four items preinstalled, as shown in Figure 4.5.

This applet demonstrates a queue based on an array. This is a common approach, although linked lists are also commonly used to implement queues.

The two basic queue operations are inserting an item, which is placed at the rear of the queue, and *removing* an item, which is taken from the front of the queue. This is similar to a person joining the rear of a line of movie-goers, and, having arrived at the front of the line and purchased a ticket, removing themselves from the front of the line.

The terms for insertion and removal in a stack are fairly standard; everyone says *push* and *pop*. Standardization hasn't progressed this far with queues. *Insert* is also called *put* or *add* or *enqueue*, while *remove* may be called *delete*

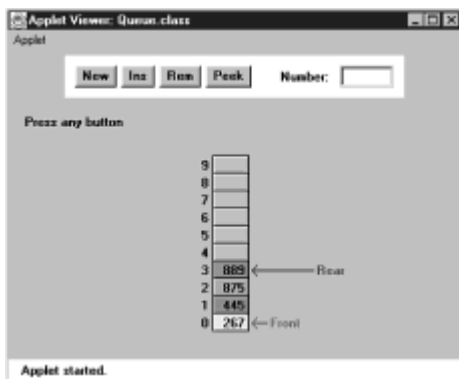

Figure 4.5: The Queue Workshop applet

The rear of the queue, where items are inserted, is also called the *back* or *tail* or *end*. The front, where items are removed, may also be called the *head*. We'll use the terms insert, remove, front, and rear.

Insert

By repeatedly pressing the Ins button in the Queue Workshop applet, you can insert a new item. After the first press, you're prompted to enter a key value for a new item into the Number text field; this should be a number from 0 to 999. Subsequent presses will insert an item with this key at the rear of the queue and increment the Rear arrow so it points to the new item.

Remove

Similarly, you can remove the item at the front of the queue using the Rem button. The person is removed, the person's value is stored in the Number field (corresponding to the `remove()` method returning a value) and the Front arrow is incremented. In the applet, the cell that held the deleted item is grayed to show it's gone. In a normal implementation, it would remain in memory but would not be accessible because Front had moved past it. The insert and remove operations are shown in Figure 4.6.

Unlike the situation in a stack, the items in a queue don't always extend all the way down to index 0 in the array. Once some items are removed, Front will point at a cell with a higher index, as shown in Figure 4.7.

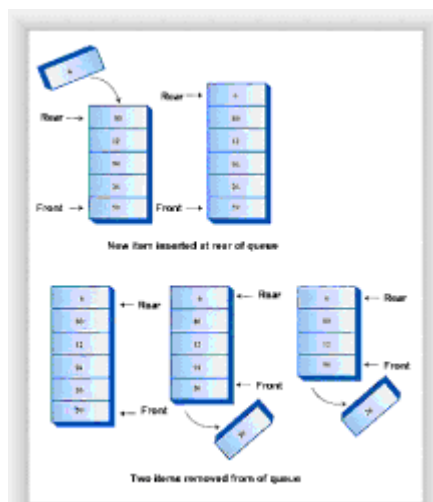

Figure 4.6: Operation of the `Queue` class methods

Notice that in this figure Front lies below Rear in the array; that is, Front has a lower index. As we'll see in a moment, this isn't always true.

Peek

We show one other queue operation, peek. This finds the value of the item at the front of the queue without removing the item. (Like insert and remove, peek when applied to a queue is also called by a variety of other names.) If you press the Peek button, you'll see the value at Front transferred to the Number box. The queue is unchanged.

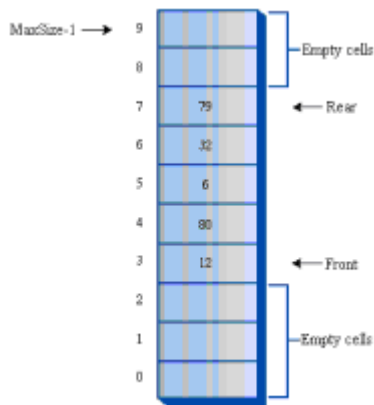

Figure 4.7: A queue with some items removed

This `peek()` method returns the value at the front of the queue. Some queue implementations have a `rearPeek()` and a `frontPeek()` method, but usually you want to know what you're about to remove, not what you just inserted.

New

If you want to start with an empty queue, you can use the New button to create one.

Empty and Full

If you try to remove an item when there are no more items in the queue, you'll get the `Can't remove, queue is empty` error message. If you try to insert an item when all the cells are already occupied, you'll get the `Can't insert, queue is full` message.

A Circular Queue

When you insert a new item in the queue in the Workshop applet, the Front arrow moves upward, toward higher numbers in the array. When you remove an item, Rear also moves upward. Try these operations with the Workshop applet to convince yourself it's true. You may find the arrangement counter-intuitive, because the people in a line at the movies all move forward, toward the front, when a person leaves the line. We could move all the items in a queue whenever we deleted one, but that wouldn't be very efficient. Instead we keep all the items in the same place and move the front and rear of the queue.

The trouble with this arrangement is that pretty soon the rear of the queue is at the end of the array (the highest index). Even if there are empty cells at the beginning of the array, because you've removed them with `Rem`, you still can't insert a new item because `Rear` can't go any further. Or can it? This situation is shown in [Figure 4.8](#).

Wrapping Around

To avoid the problem of not being able to insert more items into the queue even when it's not full, the Front and Rear arrows *wrap around* to the beginning of the array. The result is a *circular queue* (sometimes called a *ring buffer*).

You can see how wraparound works with the Workshop applet. Insert enough items to bring the Rear arrow to the top of the array (index 9). Remove some items from the front of the array. Now, insert another item. You'll see the Rear arrow wrap around from index 9 to index 0; the new item will be inserted there. This is shown in [Figure 4.9](#).

Insert a few more items. The Rear arrow moves upward as you'd expect. Notice that once Rear has wrapped around, it's now below Front, the reverse of the original arrangement. You can call this a *broken sequence*: the items in the queue are in two different sequences in the array.

Delete enough items so that the Front arrow also wraps around. Now you're back to the original arrangement, with Front below Rear. The items are in a single *contiguous sequence*.

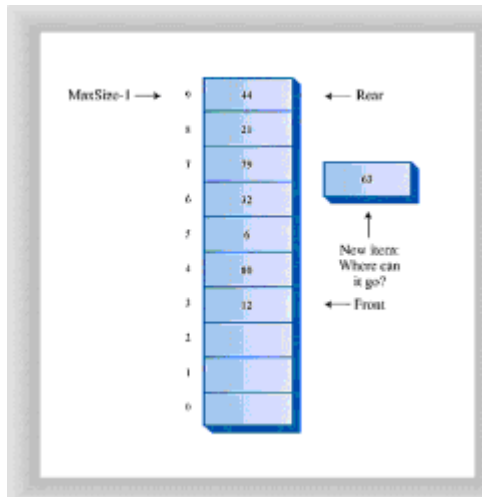

Figure 4.8: Rear arrow at the end of the array

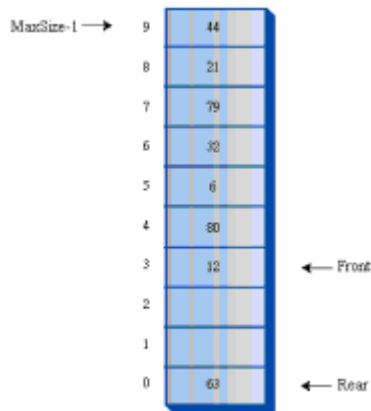

Figure 4.9: Rear arrow wraps around

Java Code for a Queue

The `queue.java` program features a `Queue` class with `insert()`, `remove()`, `peek()`, `isFull()`, `isEmpty()`, and `size()` methods.

The `main()` program creates a queue of five cells, inserts four items, removes three items, and inserts four more. The sixth insertion invokes the wraparound feature. All the items are then removed and displayed. The output looks like this:

```
40 50 60 70 80
```

Listing 4.4 shows the Queue.java program.

Listing 4.4 The Queue.java Program

```
// Queue.java
// demonstrates queue
// to run this program: C>java QueueApp
import java.io.*;          // for I/O
////////////////////////////////////
class Queue
{
    private int maxSize;
    private int[] queArray;
    private int front;
    private int rear;
    private int nItems;

//-----
-   public Queue(int s)      // constructor
    {
        maxSize = s;
        queArray = new int[maxSize];
        front = 0;
        rear = -1;
        nItems = 0;
    }

//-----
-   public void insert(int j) // put item at rear of queue
    {
        if(rear == maxSize-1) // deal with wraparound
            rear = -1;
        queArray[++rear] = j; // increment rear and
insert
        nItems++;           // one more item
    }

//-----
-   public int remove()      // take item from front of queue
    {
        int temp = queArray[front++]; // get value and incr front
        if(front == maxSize)         // deal with wraparound
            front = 0;
        nItems--;                   // one less item
        return temp;
    }

//-----
-   public int peekFront()   // peek at front of queue
    {
```

```

        return queArray[front];
    }

//-----
-
    public boolean isEmpty()    // true if queue is empty
    {
        return (nItems==0);
    }

//-----
-
    public boolean isFull()    // true if queue is full
    {
        return (nItems==maxSize);
    }

//-----
-
    public int size()          // number of items in queue
    {
        return nItems;
    }

//-----
-
} // end class Queue

////////////////////////////////////

class QueueApp
{
    public static void main(String[] args)
    {
        Queue theQueue = new Queue(5); // queue holds 5 items

        theQueue.insert(10);           // insert 4 items
        theQueue.insert(20);
        theQueue.insert(30);
        theQueue.insert(40);

        theQueue.remove();              // remove 3 items
        theQueue.remove();              // (10, 20, 30)
        theQueue.remove();

        theQueue.insert(50);            // insert 4 more items
        theQueue.insert(60);            // (wraps around)
        theQueue.insert(70);
        theQueue.insert(80);

        while( !theQueue.isEmpty() )   // remove and display
        {
            // all items
            int n = theQueue.remove();   // (40, 50, 60, 70, 80)
            System.out.print(n);
        }
    }
}

```

```

        System.out.print(" ");
    }
    System.out.println("");
} // end main()

} // end class QueueApp

```

We've chosen an approach in which `Queue` class fields include not only `front` and `rear`, but also the number of items currently in the queue: `nItems`. Some queue implementations don't use this field; we'll show this alternative later.

The `insert()` Method

The `insert()` method assumes that the queue is not full. We don't show it in `main()`, but normally you should only call `insert()` after calling `isFull()` and getting a return value of `false`. (It's usually preferable to place the check for fullness in the `insert()` routine, and cause an exception to be thrown if an attempt was made to insert into a full queue.)

Normally, insertion involves incrementing `rear` and inserting at the cell `rear` now points to. However, if `rear` is at the top of the array, at `maxSize-1`, then it must wrap around to the bottom of the array before the insertion takes place. This is done by setting `rear` to `-1`, so when the increment occurs `rear` will become 0, the bottom of the array. Finally `nItems` is incremented.

The `remove()` Method

The `remove()` method assumes that the queue is not empty. You should call `isEmpty()` to ensure this is true before calling `remove()`, or build this error-checking into `remove()`.

Removal always starts by obtaining the value at `front` and then incrementing `front`. However, if this puts `front` beyond the end of the array, it must then be wrapped around to 0. The return value is stored temporarily while this possibility is checked. Finally, `nItems` is decremented.

The `peek()` Method

The `peek()` method is straightforward: it returns the value at `front`. Some implementations allow peeking at the rear of the array as well; such routines are called something like `peekFront()` and `peekRear()` or just `front()` and `rear()`.

The `isEmpty()`, `isFull()`, and `size()` Methods

The `isEmpty()`, `isFull()`, and `size()` methods all rely on the `nItems` field, respectively checking if it's 0, if it's `maxSize`, or returning its value.

Implementation Without an Item Count

The inclusion of the field `nItems` in the `Queue` class imposes a slight overhead on the `insert()` and `remove()` methods in that they must respectively increment and decrement this variable. This may not seem like an excessive penalty, but if you're dealing with huge numbers of insertions and deletions, it might influence performance.

Accordingly, some implementations of queues do without an item count and rely on the `front` and `rear` fields to figure out whether the queue is empty or full and how many

items are in it. When this is done, the `isEmpty()`, `isFull()`, and `size()` routines become surprisingly complicated because the sequence of items may be either broken or contiguous, as we've seen.

Also, a strange problem arises. The `front` and `rear` pointers assume certain positions when the queue is full, but they can assume these exact same positions when the queue is empty. The queue can then appear to be full and empty at the same time.

This problem can be solved by making the array one cell larger than the maximum number of items that will be placed in it. Listing 4.5 shows a `Queue` class that implements this no-count approach. This class uses the no-count implementation.

Listing 4.5 The Queue Class Without `nltems`

```
class Queue
{
    private int maxSize;
    private int[] queArray;
    private int front;
    private int rear;

//-----
-
    public Queue(int s)          // constructor
    {
        maxSize = s+1;          // array is 1 cell larger
        queArray = new int[maxSize]; // than requested
        front = 0;
        rear = -1;
    }

//-----
-
    public void insert(int j)    // put item at rear of queue
    {
        if(rear == maxSize-1)
            rear = -1;
        queArray[++rear] = j;
    }

//-----
-
    public int remove()         // take item from front of queue
    {
        int temp = queArray[front++];
        if(front == maxSize)
            front = 0;
        return temp;
    }

//-----
-
    public int peek()           // peek at front of queue
    {
        return queArray[front];
    }
}
```

```

    }

//-----
-
    public boolean isEmpty()    // true if queue is empty
    {
        return ( rear+1==front || (front+maxSize-1==rear) );
    }

//-----
-
    public boolean isFull()    // true if queue is full
    {
        return ( rear+2==front || (front+maxSize-2==rear) );
    }

//-----
-
    public int size()          // (assumes queue not empty)
    {
        if(rear >= front)      // contiguous sequence
            return rear-front+1;
        else                   // broken sequence
            return (maxSize-front) + (rear+1);
    }

//-----
-

    } // end class Queue

```

Notice the complexity of the `isFull()`, `isEmpty()`, and `size()` methods. This no-count approach is seldom needed in practice, so we'll refrain from discussing it in detail.

Efficiency of Queues

As with a stack, items can be inserted and removed from a queue in $O(1)$ time.

Dequeues

A *deque* is a double-ended queue. You can insert items at either end and delete them from either end. The methods might be called `insertLeft()` and `insertRight()`, and `removeLeft()` and `removeRight()`.

If you restrict yourself to `insertLeft()` and `removeLeft()` (or their equivalents on the right), then the deque acts like a stack. If you restrict yourself to `insertLeft()` and `removeRight()` (or the opposite pair), then it acts like a queue.

A deque provides a more versatile data structure than either a stack or a queue, and is sometimes used in container class libraries to serve both purposes. However, it's not used as often as stacks and queues, so we won't explore it further here.

Priority Queues

A priority queue is a more specialized data structure than a stack or a queue. However,

it's a useful tool in a surprising number of situations. Like an ordinary queue, a priority queue has a front and a rear, and items are removed from the front. However, in a priority queue, items are ordered by key value, so that the item with the lowest key (or in some implementations the highest key) is always at the front. Items are inserted in the proper position to maintain the order.

Here's how the mail sorting analogy applies to a priority queue. Every time the postman hands you a letter, you insert it into your pile of pending letters according to its priority. If it must be answered immediately (the phone company is about to disconnect your modem line), it goes on top, while if it can wait for a leisurely answer (a letter from your Aunt Mabel), it goes on the bottom.

When you have time to answer your mail, you start by taking the letter off the top (the front of the queue), thus ensuring that the most important letters are answered first. This is shown in Figure 4.10.

Like stacks and queues, priority queues are often used as programmer's tools. We'll see one used in finding something called a minimum spanning tree for a graph, in [Chapter 14, "Weighted Graphs."](#)

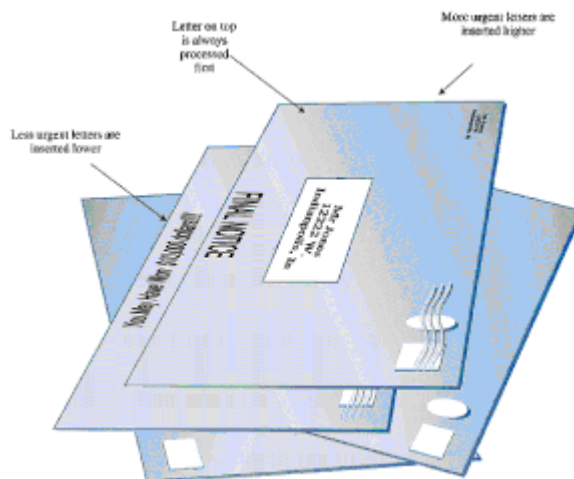

Figure 4.10: Letters in a priority queue

Also, like ordinary queues, priority queues are used in various ways in certain computer systems. In a preemptive multitasking operating system, for example, programs may be placed in a priority queue so the highest-priority program is the next one to receive a time-slice that allows it to execute.

In many situations you want access to the item with the lowest key value (which might represent the cheapest or shortest way to do something). Thus the item with the smallest key has the highest priority. Somewhat arbitrarily, we'll assume that's the case in this discussion, although there are other situations in which the highest key has the highest priority.

Besides providing quick access to the item with the smallest key, you also want a priority queue to provide fairly quick insertion. For this reason, priority queues are, as we noted earlier, often implemented with a data structure called a heap. We'll look at heaps in [Chapter 12](#). In this chapter, we'll show a priority queue implemented by a simple array. This implementation suffers from slow insertion, but it's simpler and is appropriate when the number of items isn't high or insertion speed isn't critical.

The PriorityQ Workshop Applet

The PriorityQ Workshop applet implements a priority queue with an array, in which the items are kept in sorted order. It's an *ascending-priority* queue, in which the item with the smallest key has the highest priority and is accessed with `remove()`. (If the highest-key item were accessed, it would be a *descending-priority* queue.)

The minimum-key item is always at the top (highest index) in the array, and the largest item is always at index 0. Figure 4.11 shows the arrangement when the applet is started. Initially there are five items in the queue.

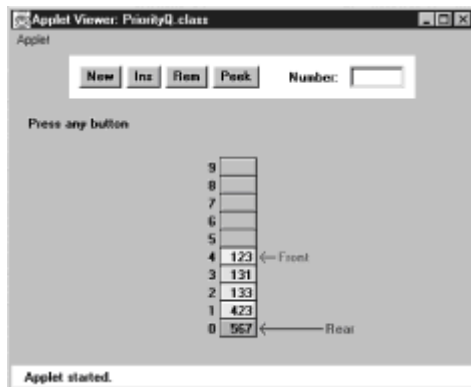

Figure 4.11: The PriorityQ Workshop applet

Insert

Try inserting an item. You'll be prompted to type the new item's key value into the Number field. Choose a number that will be inserted somewhere in the middle of the values already in the queue. For example, in Figure 4.11 you might choose 300. Then, as you repeatedly press Ins, you'll see that the items with smaller keys are shifted up to make room. A black arrow shows which item is being shifted. Once the appropriate position is found, the new item is inserted into the newly created space.

Notice that there's no wraparound in this implementation of the priority queue. Insertion is slow of necessity because the proper in-order position must be found, but deletion is fast. A wraparound implementation wouldn't improve the situation. Note too that the Rear arrow never moves; it always points to index 0 at the bottom of the array.

Delete

The item to be removed is always at the top of the array, so removal is quick and easy; the item is removed and the Front arrow moves down to point to the new top of the array. No comparisons or shifting are necessary.

In the PriorityQ Workshop applet, we show Front and Rear arrows to provide a comparison with an ordinary queue, but they're not really necessary. The algorithms know that the front of the queue is always at the top of the array at `nItems-1`, and they insert items in order, not at the rear. [Figure 4.12](#) shows the operation of the `PriorityQ` class methods.

Peek and New

You can peek at the minimum item (find its value without removing it) with the Peek button, and you can create a new, empty, priority queue with the New button.

Other Implementation Possibilities

The implementation shown in the PriorityQ Workshop applet isn't very efficient for insertion, which involves moving an average of half the items.

Another approach, which also uses an array, makes no attempt to keep the items in sorted order. New items are simply inserted at the top of the array. This makes insertion very quick, but unfortunately it makes deletion slow, because the smallest item must be searched for. This requires examining all the items and shifting half of them, on the average, down to fill in the hole. Generally, the quick-deletion approach shown in the Workshop applet is preferred.

For small numbers of items, or situations where speed isn't critical, implementing a priority queue with an array is satisfactory. For larger numbers of items, or when speed is critical, the heap is a better choice.

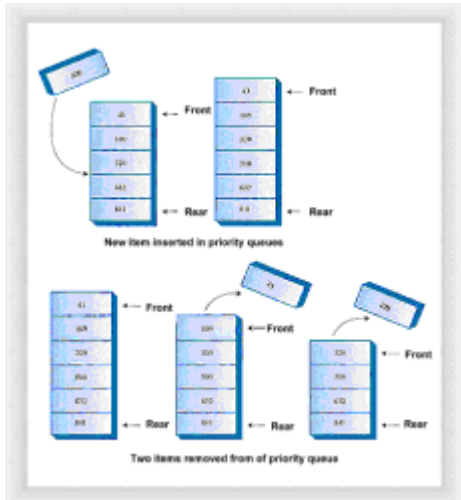

Figure 4.12: Operation of the PriorityQ class methods

Java Code for a Priority Queue

The Java code for a simple array-based priority queue is shown in Listing 4.6.

Listing 4.6 The priorityQ.java Program

```
// priorityQ.java
// demonstrates priority queue
// to run this program: C>java PriorityQApp
import java.io.*;           // for I/O
////////////////////////////////////

class PriorityQ
{
    // array in sorted order, from max at 0 to min at size-1
    private int maxSize;
    private double[] queArray;
    private int nItems;

    //-----
    public PriorityQ(int s) // constructor
    {
```

```

    maxSize = s;
    queArray = new double[maxSize];
    nItems = 0;
}

//-----
public void insert(double item) // insert item
{
    int j;

    if(nItems==0) // if no items,
        queArray[nItems++] = item; // insert at 0
    else // if any items,
        {
            for(j=nItems-1; j>=0; j--) // start at end,
                {
                    if( item > queArray[j] ) // if new item
larger,
                        queArray[j+1] = queArray[j]; // shift upward
                    else // if smaller,
                        break; // done shifting
                } // end for
            queArray[j+1] = item; // insert it
            nItems++;
        } // end else (nItems > 0)
    } // end insert()

//-----
public double remove() // remove minimum item
{ return queArray[--nItems]; }

//-----
public double peekMin() // peek at minimum item
{ return queArray[nItems-1]; }

//-----
public boolean isEmpty() // true if queue is empty
{ return (nItems==0); }

//-----
public boolean isFull() // true if queue is full
{ return (nItems == maxSize); }

//-----
} // end class PriorityQ

////////////////////////////////////

class PriorityQApp
{
    public static void main(String[] args) throws IOException
    {
        PriorityQ thePQ = new PriorityQ(5);

```

```

    thePQ.insert(30);
    thePQ.insert(50);
    thePQ.insert(10);
    thePQ.insert(40);
    thePQ.insert(20);

    while( !thePQ.isEmpty() )
    {
        double item = thePQ.remove();
        System.out.print(item + " "); // 10, 20, 30, 40, 50
    } // end while
    System.out.println("");
} // end main()

//-----

} // end class PriorityQApp

```

In `main()` we insert five items in random order and then remove and display them. The smallest item is always removed first, so the output is

```
10, 20, 30, 40, 50
```

The `insert()` method checks if there are any items; if not, it inserts one at index 0. Otherwise, it starts at the top of the array and shifts existing items upward until it finds the place where the new item should go. Then it inserts it and increments `nItems`. Note that if there's any chance the priority queue is full you should check for this possibility with `isFull()` before using `insert()`.

The `front` and `rear` fields aren't necessary as they were in the `Queue` class, because, as we noted, `front` is always at `nItems-1` and `rear` is always at 0.

The `remove()` method is simplicity itself: it decrements `nItems` and returns the item from the top of the array. The `peekMin()` method is similar, except it doesn't decrement `nItems`. The `isEmpty()` and `isFull()` methods check if `nItems` is 0 or `maxSize`, respectively.

Efficiency of Priority Queues

In the priority-queue implementation we show here, insertion runs in $O(N)$ time, while deletion takes $O(1)$ time. We'll see how to improve insertion time with heaps in [Chapter 12](#).

Parsing Arithmetic Expressions

So far in this chapter, we've introduced three different data storage structures. Let's shift gears now and focus on an important application for one of these structures. This application is *parsing* (that is, analyzing) arithmetic expressions like $2+3$ or $2*(3+4)$ or $((2+4)*7)+3*(9-5)$, and the storage structure it uses is the stack. In the `brackets.java` program, we saw how a stack could be used to check whether delimiters were formatted correctly. Stacks are used in a similar, although more complicated, way for parsing arithmetic expressions.

In some sense this section should be considered optional. It's not a prerequisite to the rest of the book, and writing code to parse arithmetic expressions is probably not something you need to do every day, unless you are a compiler writer or are designing

pocket calculators. Also, the coding details are more complex than any we've seen so far. However, it's educational to see this important use of stacks, and the issues raised are interesting in their own right.

As it turns out, it's fairly difficult, at least for a computer algorithm, to evaluate an arithmetic expression directly. It's easier for the algorithm to use a two-step process:

1. Transform the arithmetic expression into a different format, called postfix notation.
2. Evaluate the postfix expression.

Step 1 is a bit involved, but step 2 is easy. In any case, this two-step approach results in a simpler algorithm than trying to parse the arithmetic expression directly. Of course, for a human it's easier to parse the ordinary arithmetic expression. We'll return to the difference between the human and computer approaches in a moment.

Before we delve into the details of steps 1 and 2, we'll introduce postfix notation.

Postfix Notation

Everyday arithmetic expressions are written with an *operator* (+, −, *, or /) placed between two *operands* (numbers, or symbols that stand for numbers). This is called *infix* notation, because the operator is written inside the operands. Thus we say 2+2 and 4/7, or, using letters to stand for numbers, A+B and A/B.

In postfix notation (which is also called Reverse Polish Notation, or RPN, because it was invented by a Polish mathematician), the operator *follows* the two operands. Thus A+B becomes AB+, and A/B becomes AB/. More complex infix expressions can likewise be translated into postfix notation, as shown in Table 4.2. We'll explain how the postfix expressions are generated in a moment.

Table 4.2: Infix and postfix expressions

Infix	Postfix
A+B−C	AB+C−
A*B/C	AB*C/
A+B*C	ABC*+
A*B+C	AB*C+
A*(B+C)	ABC+*
A*B+C*D	AB*CD*+
(A+B)*(C−D)	AB+CD−*
((A+B)*C)−D	AB+C*D−

$A+B*(C-D)/(E+F)$ ABCDEF+/-*+

Some computer languages also have an operator for raising a quantity to a power (typically the ^ character), but we'll ignore that possibility in this discussion.

Besides infix and postfix, there's also a *prefix* notation, in which the operator is written before the operands: +AB instead of AB+. This is functionally similar to postfix but seldom used.

Translating Infix to Postfix

The next several pages are devoted to explaining how to translate an expression from infix notation into postfix. This is a fairly involved algorithm, so don't worry if every detail isn't clear at first. If you get bogged down, you may want to skip ahead to the section, "[Evaluating Postfix Expressions](#)." In understanding how to create a postfix expression, it may be helpful to see how a postfix expression is evaluated; for example, how the value 14 is extracted from the expression $234+*$, which is the postfix equivalent of $2*(3+4)$. (Notice that in this discussion, for ease of writing, we restrict ourselves to expressions with single-digit numbers, although these expressions may evaluate to multidigit numbers.)

How Humans Evaluate Infix

How do you translate infix to postfix? Let's examine a slightly easier question first: how does a human evaluate a normal infix expression? Although, as we stated earlier, this is difficult for a computer, we humans do it fairly easily because of countless hours in Mr. Klemmer's math class. It's not hard for us to find the answer to $3+4+5$, or $3*(4+5)$. By analyzing how we do this, we can achieve some insight into the translation of such expressions into postfix.

Roughly speaking, when you "solve" an arithmetic expression, you follow rules something like this:

1. You read from left to right. (At least we'll assume this is true. Sometimes people skip ahead, but for purposes of this discussion, you should assume you must read methodically, starting at the left.)
2. When you've read enough to evaluate two operands and an operator, you do the calculation and substitute the answer for these two operands and operator. (You may also need to solve other pending operations on the left, as we'll see later.)
3. This process is continued—going from left to right and evaluating when possible—until the end of the expression.

In Tables 4.3, [4.4](#), and [4.5](#) we're going to show three examples of how simple infix expressions are evaluated. Later, in [Tables 4.6](#), [4.7](#), and [4.8](#), we'll see how closely these evaluations mirror the process of translating infix to postfix.

To evaluate $3+4-5$, you would carry out the steps shown in Table 4.3.

Table 4.3: Evaluating $3+4-5$

Item Read	Expression Parsed So Far	Comments
-----------	--------------------------	----------



3	3	
+	3+	
4	3+4	
-	7	When you see the -, you can evaluate 3+4.
	7-	
5	7-5	
End	2	When you reach the end of the expression, you can evaluate 7-5.



You can't evaluate the 3+4 until you see what operator follows the 4. If it's a * or / you need to wait before applying the + sign until you've evaluated the * or /.

However, in this example the operator following the 4 is a -, which has the same precedence as a +, so when you see the - you know you can evaluate 3+4, which is 7. The 7 then replaces the 3+4. You can evaluate the 7-5 when you arrive at the end of the expression.

[Figure 4.13](#) shows how this looks in more detail. Notice how you go from left to right reading items from the input, and then, when you have enough information, you go from right to left, recalling previously examined input and evaluating each operand-operator-operand combination.

Because of precedence relationships, it's a bit more complicated to evaluate 3+4*5, as shown in Table 4.4.

Table 4.4: Evaluating 3+4*5



Item Read	Expression Parsed So Far	Comments
3	3	
+	3+	
4	3+4	
*	3+4*	Can't evaluate 3+4, because * is higher precedence than +.
5	3+4*5	When you see the 5, you can evaluate 4*5.

$$3+20$$

End

23

When you see the end of the expression, you can evaluate $3+20$.



Here you can't add the 3 until you know the result of $4*5$. Why not? Because multiplication has a higher precedence than addition. In fact, both $*$ and $/$ have a higher precedence than $+$ and $-$, so all multiplications and divisions must be carried out before any additions or subtractions (unless parentheses dictate otherwise; see the next example).

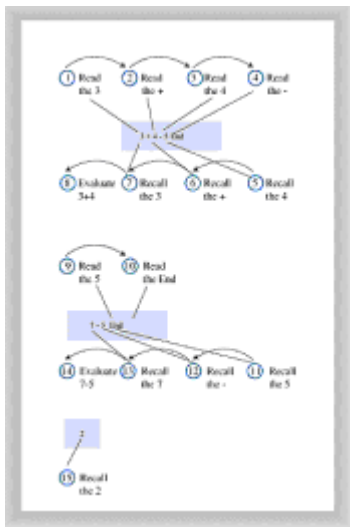

Figure 4.13: Evaluating $3+4*5$

Often you can evaluate as you go from left to right, as in the last example. However, you need to be sure, when you come to an operand-operator-operand combination like $A+B$, that the operator on the right side of the B isn't one with a higher precedence than the $+$. If it does have a higher precedence, as in this example, you can't do the addition yet. However, once you've read the 5, the multiplication can be carried out because it has the highest priority; it doesn't matter if a $*$ or $/$ follows the 5. However, you still can't do the addition until you've found out what's beyond the 5. When you find there's nothing beyond the 5 but the end of the expression, you can go ahead and do the addition. Figure 4.14 shows this process.

Parentheses can be used to override the normal precedence of operators. Table 4.5 shows how you would evaluate $3*(4+5)$. Without the parentheses you'd do the multiplication first; with them you do the addition first.

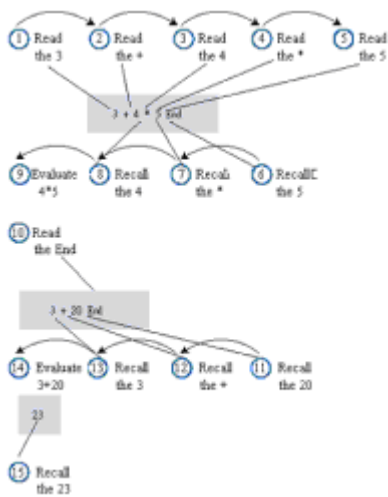

Figure 4.14: Evaluating $3*(4+5)$

Table 4.5: Evaluating $3*(4+5)$

Item Read	Expression Parsed So Far	Comments
3	3	
*	3^*	
($3^*($	
4	$3^*(4$	Can't evaluate $3*4$ because of parentheses.
+	$3^*(4+$	
5	$3^*(4+5$	Can't evaluate $4+5$ yet.
)	$3^*(4+5)$	When you see the ')' you can evaluate $4+5$.
	3^*9	When you've evaluated $4+5$, you can evaluate 3^*9 .
	27	
End		Nothing left to evaluate.

Here we can't evaluate anything until we've reached the closing parenthesis. Multiplication has a higher or equal precedence compared to the other operators, so ordinarily we could carry out $3*4$ as soon as we see the 4. However, parentheses have

an even higher precedence than $*$ and $/$. Accordingly, we must evaluate anything in parentheses before using the result as an operand in any other calculation. The closing parenthesis tells us we can go ahead and do the addition. We find that $4+5$ is 9, and once we know this, we can evaluate $3*9$ to obtain 27. Reaching the end of the expression is an anticlimax because there's nothing left to evaluate. The process is shown in Figure 4.15.

As we've seen, in evaluating an infix arithmetic expression, you go both forward and backward through the expression. You go forward (left to right) reading operands and operators. When you have enough information to apply an operator, you go backward, recalling two operands and an operator and carrying out the arithmetic.

Sometimes you must defer applying operators if they're followed by higher precedence operators or by parentheses. When this happens you must apply the later, higher-precedence, operator first; then go backward (to the left) and apply earlier operators.

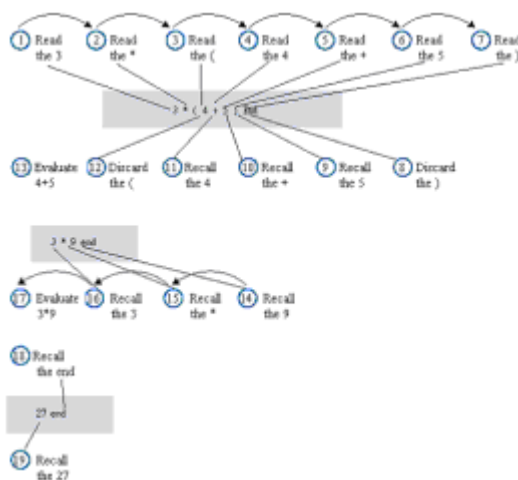

Figure 4.15: Evaluating $3*(4+5)$

We could write an algorithm to carry out this kind of evaluation directly. However, as we noted, it's actually easier to translate into postfix notation first.

How Humans Translate Infix to Postfix

To translate infix to postfix notation, you follow a similar set of rules to those for evaluating infix. However, there are a few small changes. You don't do any arithmetic. The idea is not to evaluate the infix expression, but to rearrange the operators and operands into a different format: postfix notation. The resulting postfix expression will be evaluated later.

As before, you read the infix from left to right, looking at each character in turn. As you go along, you copy these operands and operators to the postfix output string. The trick is knowing when to copy what.

If the character in the infix string is an operand, you copy it immediately to the postfix string. That is, if you see an A in the infix, you write an A to the postfix. There's never any delay: you copy the operands as you get to them, no matter how long you must wait to copy their associated operators.

Knowing when to copy an operator is more complicated, but it's the same as the rule for evaluating infix expressions. Whenever you could have used the operator to evaluate part of the infix expression (if you were evaluating instead of translating to postfix), you instead copy it to the postfix string.

Table 4.6 shows how $A+B-C$ is translated into postfix notation.

Table 4.6: Translating $A+B-C$ into postfix

Character Read from Infix Expression	Infix Expression Parsed So Far	Postfix Expression Written So Far	Comments
A	A	A	
+	A+	A	
B	A+B	AB	
-	A+B-	AB+	When you see the -, you can copy the + to the postfix string.
C	A+B-C	AB+C	
End	A+B-C	AB+C-	When you reach the end of the expression, you can copy the -.

Notice the similarity of this table to [Table 4.3](#), which showed the evaluation of the infix expression $3+4-5$. At each point where you would have done an evaluation in the earlier table, you instead simply write an operator to the postfix output.

Table 4.7 shows the translation of $A+B*C$ to postfix. This is similar to [Table 4.4](#), which covered the evaluation of $3+4*5$.

Table 4.7: Translating $A+B*C$ to postfix

Character Read from Infix Expression	Infix Expression Parsed So Far	Postfix Expression Written So Far	Comments
A	A	A	
+	A+	A	
B	A+B	AB	

*	A+B*	AB	Can't copy the +, because * is higher precedence than +.
C	A+B*C	ABC	When you see the C, you can copy the *.
	A+B*C	ABC*	
End	A+B*C	ABC*+	When you see the end of the expression, you can copy the +.

As the final example, Table 4.8 shows how $A*(B+C)$ is translated to postfix. This is similar to evaluating $3*(4+5)$ in [Table 4.5](#). You can't write any postfix operators until you see the closing parenthesis in the input.

Table 4.8: Translating $3*(4+5)$ into postfix

Character Read from Infix Expression	Infix Expression Parsed So Far	Postfix Expression Written So Far	Comments
A	A	A	
*	A*	A	
(A*(A	
B	A*(B	AB	Can't copy * because of parenthesis.
+	A*(B+	AB	
C	A*(B+C	ABC	Can't copy the + yet.
)	A*(B+C)	ABC+	When you see the) you can copy the +.
	A*(B+C)	ABC*+	When you've copied the +, you can copy the*.

End	$A*(B+C)$	$ABC+*$	Nothing left to copy.
-----	-----------	---------	-----------------------

As in the numerical evaluation process, you go both forward and backward through the infix expression to complete the translation to postfix. You can't write an operator to the output (postfix) string if it's followed by a higher-precedence operator or a left parenthesis. If it is, the higher precedence operator, or the operator in parentheses, must be written to the postfix before the lower priority operator.

Saving Operators on a Stack

You'll notice in both [Table 4.7](#) and Table 4.8 that the order of the operators is reversed going from infix to postfix. Because the first operator can't be copied to the output until the second one has been copied, the operators were output to the postfix string in the opposite order they were read from the infix string. A longer example may make this clearer. Table 4.9 shows the translation to postfix of the infix expression $A+B*(C-D)$. We include a column for stack contents, which we'll explain in a moment.

Table 4.9: Translating $A+B*(C-D)$ to postfix

Character Read from Infix Expression	Infix Expression Parsed So Far	Postfix Expression Written So Far	Stack Contents
A	A	A	
+	A+	A	+
B	A+B	AB	+
*	A+B*	AB	+*
(A+B*(AB	+*(
C	A+B*(C	ABC	+*(
-	A+B*(C-	ABC	+*(-
D	A+B*(C-D	ABCD	+*(-
)	A+B*(C-D)	ABCD-	+*(
	A+B*(C-D)	ABCD-	+*(
	A+B*(C-D)	ABCD-	+
	A+B*(C-D)	ABCD-*	+
	A+B*(C-D)	ABCD-*+	

Here we see the order of the operands is $+*$ in the original infix expression, but the reverse order, $-*+$, in the final postfix expression. This happens because $*$ has higher precedence than $+$, and $-$, because it's in parentheses, has higher precedence than $*$.

This order reversal suggests a stack might be a good place to store the operators while we're waiting to use them. The last column in Table 4.9 shows the stack contents at various stages in the translation process.

Popping items from the stack allows you to, in a sense, go backward (right to left) through the input string. You're not really examining the entire input string, only the operators and parentheses. These were pushed on the stack when reading the input, so now you can recall them in reverse order by popping them off the stack.

The operands (A, B, and so on) appear in the same order in infix and postfix, so you can write each one to the output as soon as you encounter it; they don't need to be stored on a stack.

Translation Rules

Let's make the rules for infix-to-postfix translation more explicit. You read items from the infix input string and take the actions shown in Table 4.10. These actions are described in pseudocode, a blend of Java and English.

In this table, the $<$ and \geq symbols refer to the operator precedence relationship, not numerical values. The `opThis` operator has just been read from the infix input, while the `opTop` operator has just been popped off the stack.

Table 4.10: Translation rules

Item Read from Input(Infix)	Action
Operand	Write it to output (postfix)
Open parenthesis (Push it on stack
Close parenthesis)	While stack not empty, repeat the following: Pop an item, If item is not (, write it to output Quit loop if item is (
Operator (<code>opThis</code>)	If stack empty, Push <code>opThis</code> Otherwise,

While stack not empty, repeat:

Pop an item,

If item is (, push it, or

If item is an operator (op_{Top}), and

If $op_{Top} < op_{This}$, push op_{Top} , or

If $op_{Top} \geq op_{This}$, output op_{Top}

Quit loop if $op_{Top} < op_{This}$ or item is (

Push op_{This}

No more items

While stack not empty,

Pop item, output it.

It may take some work to convince yourself that these rules work. Tables 4.11, 4.12, and 4.13 show how the rules apply to three sample infix expressions. These are similar to Tables 4.6, 4.7, and 4.8, except that the relevant rules for each step have been added. Try creating similar tables by starting with other simple infix expressions and using the rules to translate some of them to postfix.

Table 4.11: Translation Rules Applied to A+B-C

Character Read from Infix	Infix Parsed So Far	Postfix Written So Far	Stack Contents	Rule
A	A	A		Write operand to output.
+	A+	A	+	If stack empty, push op_{This} .
B	A+B	AB	+	Write operand to output.
-	A+B-	AB		Stack not empty, so pop item.
	A+B-	AB+		op_{This} is -, op_{Top} is +, $op_{Top} \geq op_{This}$, so output op_{Top} .

	A+B-	AB+	-	Then push opThis.
C	A+B-C	AB+C	-	Write operand to output.
End	A+B-C	AB+C-		Pop leftover item, output it.

Table 4.12: Translation rules applied to A+B*C

Character Read from Infix	Infix Parsed So Far	Postfix Written So Far	Stack Contents	Rule
A	A	A		Write operand to postfix.
+	A+	A	+	If stack empty, push opThis.
B	A+B	AB	+	Write operand to output.
*	A+B*	AB	+	Stack not empty, so pop opTop.
	A+B*	AB	+	opThis is *, opTop is + opTop < opThis, so push opTop.
	A+B*	AB	+	Then push opThis.
C	A+B*C	ABC	+	Write operand to output.
End	A+B*C	ABC*	+	Pop leftover item, output it.
	A+B*C	ABC*+		Pop leftover item, output it.

Table 4.13: Translation Rules Applied to A*(B+C)

Character Read from Infix	Infix Parsed So Far	Postfix Written So Far	Stack Contents	Rule
A	A	A		Write operand to postfix.
*	A*	A	*	If stack empty, push opThis.
(A*(A	*(Push (on stack.
B	A*(B	AB	*(Write operand to postfix.
+	A*(B+	AB	*	Stack not empty, so pop item.
	A*(B+	AB	*(It's (, so push it.
	A*(B+	AB	*(+	Then push opThis.
C	A*(B+C	ABC	*(+	Write operand to postfix.
)	A*(B+C)	ABC+	*(Pop item, write to output.
	A*(B+C)	ABC+	*	Quit popping if (.
End	A*(B+C)	ABC+*		Pop leftover item, output it.

Java Code to Convert Infix to Postfix

Listing 4.7 shows the `infix.java` program, which uses the rules of Table 4.10 to translate an infix expression to a postfix expression.

Listing 4.7 The `infix.java` Program

```
// infix.java
// converts infix arithmetic expressions to postfix
// to run this program: C>java InfixApp
import java.io.*;           // for I/O
```

```

////////////////////////////////////
class StackX
{
    private int maxSize;
    private char[] stackArray;
    private int top;

//-----
-
    public StackX(int s)        // constructor
    {
        maxSize = s;
        stackArray = new char[maxSize];
        top = -1;
    }

//-----
-
    public void push(char j)    // put item on top of stack
    { stackArray[++top] = j; }

//-----
-
    public char pop()           // take item from top of stack
    { return stackArray[top--]; }

//-----
-
    public char peek()          // peek at top of stack
    { return stackArray[top]; }

//-----
-
    public boolean isEmpty()    // true if stack is empty
    { return (top == -1); }

//-----
    public int size()           // return size
    { return top+1; }

//-----
-
    public char peekN(int n)    // return item at index n
    { return stackArray[n]; }

//-----
-
    public void displayStack(String s)
    {
        System.out.print(s);
        System.out.print("Stack (bottom-->top): ");
        for(int j=0; j<size(); j++)
        {
            System.out.print( peekN(j) );
            System.out.print(' ');
        }
    }
}

```

```

    }
    System.out.println("");
}

//-----
-
} // end class StackX

////////////////////////////////////

                // infix to postfix conversion
{
private StackX theStack;
private String input;
private String output = "";

//-----
-
public InToPost(String in) // constructor
{
    input = in;
    int stackSize = input.length();
    theStack = new StackX(stackSize);
}

//-----
-
public String doTrans() // do translation to postfix
{
    for(int j=0; j<input.length(); j++)
    {
        char ch = input.charAt(j);
        theStack.displayStack("For "+ch+" "); // *diagnostic*
        switch(ch)
        {
            case '+': // it's + or -
            case '-':
                gotOper(ch, 1); // go pop operators
                break; // (precedence 1)
            case '*': // it's * or /
            case '/':
                gotOper(ch, 2); // go pop operators
                break; // (precedence 2)
            case '(': // it's a left paren
                theStack.push(ch); // push it
                break;
            case ')': // it's a right paren
                gotParen(ch); // go pop operators
                break;
            default: // must be an operand
                output = output + ch; // write it to output
                break;
        } // end switch
    }
}

```

```

    } // end for
while( !theStack.isEmpty() ) // pop remaining opers
    {
        theStack.displayStack("While "); // *diagnostic*
        output = output + theStack.pop(); // write to output
    }
theStack.displayStack("End "); // *diagnostic*
return output; // return postfix
} // end doTrans()

//-----
-
public void gotOper(char opThis, int prec1)
{ // got operator from
input
while( !theStack.isEmpty() )
    {
        char opTop = theStack.pop();
        if( opTop == '(' ) // if it's a '('
            {
                theStack.push(opTop); // restore '('
                break;
            }
        else // it's an operator
            {
                int prec2; // precedence of new op

                if(opTop=='+' || opTop=='-') // find new op prec
                    prec2 = 1;
                else
                    prec2 = 2;
                if(prec2 < prec1) // if prec of new op
less
                    { // than prec of old
                        theStack.push(opTop); // save newly-popped op
                        break;
                    }
                else // prec of new not less
                    output = output + opTop; // than prec of old
            } // end else (it's an operator)
    } // end while
theStack.push(opThis); // push new operator
} // end gotOp()

//-----
-
public void gotParen(char ch)
{ // got right paren from
input
while( !theStack.isEmpty() )
    {
        char chx = theStack.pop();
        if( chx == '(' ) // if popped '('
            break; // we're done
    }
}

```

```

        else                                // if popped operator
            output = output + chx; // output it
        } // end while
    } // end popOps()

//-----
-
    } // end class InToPost

////////////////////////////////////

class InfixApp
{
    public static void main(String[] args) throws IOException
    {
        String input, output;
        while(true)
        {
            System.out.print("Enter infix: ");
            System.out.flush();
            input = getString(); // read a string from kbd
            if( input.equals("") ) // quit if [Enter]
                break;

            // make a translator
            InToPost theTrans = new InToPost(input);
            output = theTrans.doTrans(); // do the translation
            System.out.println("Postfix is " + output + '\n');
        } // end while
    } // end main()

//-----
-
    public static String getString() throws IOException
    {
        InputStreamReader isr = new InputStreamReader(System.in);
        BufferedReader br = new BufferedReader(isr);
        String s = br.readLine();
        return s;
    }

//-----
-

} // end class InfixApp

```

The `main()` routine in the `InfixApp` class asks the user to enter an infix expression. The input is read with the `getString()` utility method. The program creates an `InToPost` object, initialized with the input string. Then it calls the `doTrans()` method for this object to perform the translation. This method returns the postfix output string, which is displayed.

The `doTrans()` method uses a `switch` statement to handle the various translation rules shown in [Table 4.10](#). It calls the `gotOper()` method when it reads an operator and the `gotParen()` method when it reads a closing parenthesis ')'. These methods

implement the second two rules in the table, which are more complex than other rules.

We've included a `displayStack()` method to display the entire contents of the stack in the `StackX` class. In theory, this isn't playing by the rules; you're only supposed to access the item at the top. However, as a diagnostic aid it's useful to see the contents of the stack at each stage of the translation. Here's some sample interaction with `infix.java`:

```
Enter infix: Input=A*(B+C)-D/(E+F)
For A Stack (bottom-->top):
For * Stack (bottom-->top):
For ( Stack (bottom-->top): *
For B Stack (bottom-->top): * (
For + Stack (bottom-->top): * (
For C Stack (bottom-->top): * ( +
For ) Stack (bottom-->top): * ( +
For - Stack (bottom-->top): *
For D Stack (bottom-->top): -
Parsing Arithmetic ExpressionsFor / Stack (bottom-->top): -
For ( Stack (bottom-->top): - /
For E Stack (bottom-->top): - / (
For + Stack (bottom-->top): - / (
For F Stack (bottom-->top): - / ( +
For ) Stack (bottom-->top): - / ( +
While Stack (bottom-->top): - /
While Stack (bottom-->top): -
End Stack (bottom-->top):
Postfix is ABC+*DEF+/-
```

The output shows where the `displayStack()` method was called (from the `for` loop, the `while` loop, or at the end of the program) and within the `for` loop, what character has just been read from the input string.

You can use single-digit numbers like 3 and 7 instead of symbols like A and B. They're all just characters to the program. For example:

```
Enter infix: Input=2+3*4
For 2 Stack (bottom-->top):
For + Stack (bottom-->top):
For 3 Stack (bottom-->top): +
For * Stack (bottom-->top): +
For 4 Stack (bottom-->top): + *
While Stack (bottom-->top): + *
While Stack (bottom-->top): +
End Stack (bottom-->top):
Postfix is 234*+
```

Of course, in the postfix output, the 234 means the separate numbers 2, 3, and 4.

The `infix.java` program doesn't check the input for errors. If you type an incorrect infix expression, the program will provide erroneous output or crash and burn.

Experiment with this program. Start with some simple infix expressions, and see if you can predict what the postfix will be. Then run the program to verify your answer. Pretty soon, you'll be a postfix guru, much sought-after at cocktail parties.

Evaluating Postfix Expressions

As you can see, it's not trivial to convert infix expressions to postfix expressions. Is all this trouble really necessary? Yes, the payoff comes when you evaluate a postfix expression. Before we show how simple the algorithm is, let's examine how a human might carry out such an evaluation.

How Humans Evaluate Postfix

Figure 4.16 shows how a human can evaluate a postfix expression using visual inspection and a pencil.

Start with the first operator on the left, and draw a circle around it and the two operands to its immediate left. Then apply the operator to these two operands—performing the actual arithmetic—and write down the result inside the circle. In the figure, evaluating $4+5$ gives 9.

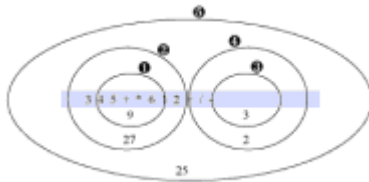

Figure 4.16: Visual approach to postfix evaluation of $3\ 4\ 5\ +\ *\ 6\ 2\ /\ -$

Now go to the next operator to the right, and draw a circle around it, the circle you already drew, and the operand to the left of that. Apply the operator to the previous circle and the new operand, and write the result in the new circle. Here $3*9$ gives 27. Continue this process until all the operators have been applied: $1+2$ is 3, and $6/3$ is 2. The answer is the result in the largest circle: $27-2$ is 25.

Rules for Postfix Evaluation

How do we write a program to reproduce this evaluation process? As you can see, each time you come to an operator, you apply it to the last two operands you've seen. This suggests that it might be appropriate to store the operands on a stack. (This is the opposite of the infix to postfix translation algorithm, where *operators* were stored on the stack.) You can use the rules shown in Table 4.14 to evaluate postfix expressions.

Table 4.14: Evaluating a postfix expression

Item Read from Postfix Expression	Action
Operand	Push it onto the stack.
Operator	Pop the top two operands from the stack, and apply the operator to them. Push the result.



When you're finished, pop the stack to obtain the answer. That's all there is to it. This process is the computer equivalent of the human circle-drawing approach of Figure 4.16.

Java Code to Evaluate Postfix Expressions

In the infix-to-postfix translation, we used symbols (A, B, and so on) to stand for numbers. This worked because we weren't performing arithmetic operations on the operands, but merely rewriting them in a different format.

Now we want to evaluate a postfix expression, which means carrying out the arithmetic and obtaining an answer. Thus the input must consist of actual numbers. To simplify the coding we've restricted the input to single-digit numbers.

Our program evaluates a postfix expression and outputs the result. Remember numbers are restricted to one digit. Here's some simple interaction:

```
Enter postfix: 57+
5 Stack (bottom-->top):
7 Stack (bottom-->top): 5
+ Stack (bottom-->top): 5 7
Evaluates to 12
```

You enter digits and operators, with no spaces. The program finds the numerical equivalent. Although the input is restricted to single-digit numbers, the results are not; it doesn't matter if something evaluates to numbers greater than 9. As in the `infix.java` program, we use the `displayStack()` method to show the stack contents at each step. Listing 4.8 shows the `postfix.java` program.

Listing 4.8 The `postfix.java` Program

```
// postfix.java
// parses postfix arithmetic expressions
// to run this program: C>java PostfixApp
import java.io.*;          // for I/O
////////////////////////////////////
class StackX
{
    private int maxSize;
    private int[] stackArray;
    private int top;

//-----
-   public StackX(int size)    // constructor
    {
        maxSize = size;
        stackArray = new int[maxSize];
        top = -1;
    }

//-----
-   public void push(int j)    // put item on top of stack
```

```

        { stackArray[++top] = j; }

//-----
-
    public int pop()          // take item from top of stack
        { return stackArray[top--]; }

//-----
-
    public int peek()        // peek at top of stack
        { return stackArray[top]; }

//-----
-
    public boolean isEmpty() // true if stack is empty
        { return (top == -1); }

//-----
-
    public boolean isFull()  // true if stack is full
        { return (top == maxSize-1); }

//-----
-
    public int size()        // return size
        { return top+1; }

//-----
-
    public int peekN(int n)  // peek at index n
        { return stackArray[n]; }

//-----
-
    public void displayStack(String s)
        {
            System.out.print(s);
            System.out.print("Stack (bottom-->top): ");
            for(int j=0; j<size(); j++)
                {
                    System.out.print( peekN(j) );
                    System.out.print(' ');
                }
            System.out.println("");
        }

//-----
-
    } // end class StackX

////////////////////////////////////

class ParsePost
    {
        private StackX theStack;

```

```

private String input;

//-----
-
public ParsePost(String s)
    { input = s; }

//-----
-
public int doParse()
    {
    theStack = new StackX(20);           // make new stack
    char ch;
    int j;
    int num1, num2, interAns;

    for(j=0; j<input.length(); j++)     // for each char,
        {
        ch = input.charAt(j);           // read from input
        theStack.displayStack(""+ch+" "); // *diagnostic*
        if(ch >= '0' && ch <= '9')     // if it's a number
            theStack.push( (int)(ch-'0') ); // push it
        else                             // it's an operator
            {
            num2 = theStack.pop();       // pop operands
            num1 = theStack.pop();
            switch(ch)                   // do arithmetic
                {
                case '+':
                    interAns = num1 + num2;
                    break;
                case '-':
                    interAns = num1 - num2;
                    break;
                case '*':
                    interAns = num1 * num2;
                    break;
                case '/':
                    interAns = num1 / num2;
                    break;
                default:
                    interAns = 0;
                } // end switch
            theStack.push(interAns);     // push result
        } // end else
    } // end for
    interAns = theStack.pop();          // get answer
    return interAns;
    } // end doParse()
} // end class ParsePost

////////////////////////////////////

```

```

class PostfixApp
{
    public static void main(String[] args) throws IOException
    {
        String input;
        int output;

        while(true)
        {
            System.out.print("Enter postfix: ");
            System.out.flush();
            input = getString();          // read a string from kbd
            if( input.equals("") )       // quit if [Enter]
                break;

                                     // make a parser
            ParsePost aParser = new ParsePost(input);
            output = aParser.doParse(); // do the evaluation
            System.out.println("Evaluates to " + output);
        } // end while
    } // end main()

//-----
-
    public static String getString() throws IOException
    {
        InputStreamReader isr = new InputStreamReader(System.in);
        BufferedReader br = new BufferedReader(isr);
        String s = br.readLine();
        return s;
    }

//-----
-

    } // end class PostfixApp

```

The `main()` method in the `PostfixApp` class gets the postfix string from the user and then creates a `ParsePost` object, initialized with this string. It then calls the `doParse()` method of `ParsePost` to carry out the evaluation.

The `doParse()` method reads through the input string, character by character. If the character is a digit, it's pushed onto the stack. If it's an operator, it's applied immediately to the two operators on the top of the stack. (These operators are guaranteed to be on the stack already, because the input string is in postfix notation.)

The result of the arithmetic operation is pushed onto the stack. Once the last character (which must be an operator) is read and applied, the stack contains only one item, which is the answer to the entire expression.

Here's some interaction with more complex input: the postfix expression `345+*612+/-`, which we showed a human evaluating in [Figure 4.16](#). This corresponds to the infix `3*(4+5)-6/(1+2)`. (We saw an equivalent translation using letters instead of numbers in the last section: `A*(B+C)-D/(E+F)` in infix is `ABC+*DEF+/-` in postfix.) Here's how the postfix is evaluated by the `postfix.java` program:

```

Enter postfix: 345+*612+/-
3 Stack (bottom-->top) :
4 Stack (bottom-->top) : 3
5 Stack (bottom-->top) : 3 4
+ Stack (bottom-->top) : 3 4 5
* Stack (bottom-->top) : 3 9
6 Stack (bottom-->top) : 27
1 Stack (bottom-->top) : 27 6
2 Stack (bottom-->top) : 27 6 1
+ Stack (bottom-->top) : 27 6 1 2
/ Stack (bottom-->top) : 27 6 3
- Stack (bottom-->top) : 27 2
Evaluates to 25

```

As with the last program, `postfix.java` doesn't check for input errors. If you type in a postfix expression that doesn't make sense, results are unpredictable.

Experiment with the program. Trying different postfix expressions and seeing how they're evaluated will give you an understanding of the process faster than reading about it.

Summary

- Stacks, queues, and priority queues are data structures usually used to simplify certain programming operations.
- In these data structures, only one data item can be accessed.
- A stack allows access to the last item inserted.
- The important stack operations are pushing (inserting) an item onto the top of the stack and popping (removing) the item that's on the top.
- A queue allows access to the first item that was inserted.
- The important queue operations are inserting an item at the rear of the queue and removing the item from the front of the queue.
- A queue can be implemented as a circular queue, which is based on an array in which the indices wrap around from the end of the array to the beginning.
- A priority queue allows access to the smallest (or sometimes the largest) item.
- The important priority queue operations are inserting an item in sorted order and removing the item with the smallest key.
- These data structures can be implemented with arrays or with other mechanisms such as linked lists.
- Ordinary arithmetic expressions are written in infix notation, so-called because the operator is written between the two operands.
- In postfix notation, the operator follows the two operands.
- Arithmetic expressions are typically evaluated by translating them to postfix notation and then evaluating the postfix expression.

- A stack is a useful tool both for translating an infix to a postfix expression and for evaluating a postfix expression.

Chapter 5: **Linked Lists**

Overview

In [Chapter 2, "Arrays,"](#) we saw that arrays had certain disadvantages as data storage structures. In an unordered array, searching is slow, whereas in an ordered array, insertion is slow. In both kinds of arrays deletion is slow. Also, the size of an array can't be changed after it's created.

In this chapter we'll look at a data storage structure that solves some of these problems: the *linked list*. Linked lists are probably the second most commonly used general-purpose storage structures after arrays.

The linked list is a versatile mechanism suitable for use in many kinds of general-purpose databases. It can also replace an array as the basis for other storage structures such as stacks and queues. In fact, you can use a linked list in many cases where you use an array (unless you need frequent random access to individual items using an index).

Linked lists aren't the solution to all data storage problems, but they are surprisingly versatile and conceptually simpler than some other popular structures such as trees. We'll investigate their strengths and weaknesses as we go along.

In this chapter we'll look at simple linked lists, double-ended lists, sorted lists, doubly linked lists, and lists with iterators (an approach to random access to list elements). We'll also examine the idea of Abstract Data Types (ADTs) and see how stacks and queues can be viewed as ADTs and how they can be implemented as linked lists instead of arrays.

Links

In a linked list, each data item is embedded in a *link*. A link is an object of a class called something like `Link`. Because there are many similar links in a list, it makes sense to use a separate class for them, distinct from the linked list itself. Each link object contains a reference (usually called `next`) to the next link in the list. A field in the list itself contains a reference to the first link. This is shown in [Figure 5.1](#).

Here's part of the definition of a class `Link`. It contains some data and a reference to the next link.

```
class Link
{
    public int iData;        // data
    public double dData;    // data
    public Link next;       // reference to next link
}
```

This kind of class definition is sometimes called *self-referential* because it contains a field—called `next` in this case—of the same type as itself.

We show only two data items in the link: an `int` and a `double`. In a typical application there would be many more. A personnel record, for example, might have name, address, Social Security number, title, salary, and many other fields. Often an object of a class that contains this data is used instead of the items:

```

class Link
{
    public inventoryItem iI; // object holding data
    public Link next;       // reference to next link

}

```



Figure 5.1: Links in a list

References and Basic Types

It's easy to get confused about references in the context of linked lists, so let's review how they work.

It may seem odd that you can put a field of type `Link` inside the class definition of this same type. Wouldn't the compiler be confused? How can it figure out how big to make a `Link` object if a link contains a link and the compiler doesn't already know how big a `Link` object is?

The answer is that a `Link` object doesn't really contain another `Link` object, although it may look like it does. The `next` field of type `Link` is only a *reference* to another link, not an object.

A reference is a number that *refers* to an object. It's the object's address in the computer's memory, but you don't need to know its value; you just treat it as a magic number that tells you where the object is. In a given computer/operating system, all references, no matter what they refer to, are the same size. Thus it's no problem for the compiler to figure out how big this field should be, and thereby construct an entire `Link` object.

Note that in Java, primitive types like `int` and `double` are stored quite differently than objects. Fields containing primitive types do not contain references, but actual numerical values like 7 or 3.14159. A variable definition like

```
double salary = 65000.00;
```

creates a space in memory and puts the number 65000.00 into this space. However, a reference to an object, like

```
Link aLink = someLink;
```

puts a reference to an object of type `Link`, called `someLink`, into `aLink`. The `someLink` object isn't moved, or even created, by this statement; it must have been created before. To create an object you must always use `new`:

```
Link someLink = new Link();
```

Even the `someLink` field doesn't hold an object, it's still just a reference. The object is somewhere else in memory, as shown in Figure 5.2.

Other languages, like C++, handle objects quite differently than Java. In C++ a field like

```
Link next;
```

actually contains an object of type `Link`. You can't write a self-referential class definition in C++ (although you can put a pointer to a `Link` in class `Link`; a pointer is similar to a reference). C++ programmers should keep in mind how Java handles objects; it may be counter intuitive.

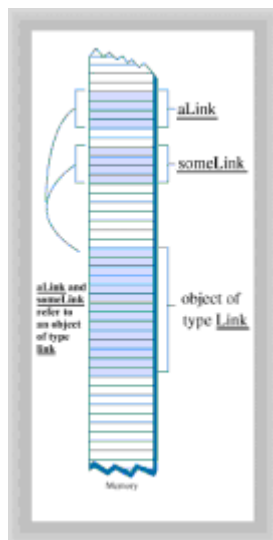

Figure 5.2: Objects and references in memory

Relationship, Not Position

Let's examine one of the major ways in which linked lists differ from arrays. In an array each item occupies a particular position. This position can be directly accessed using an index number. It's like a row of houses: you can find a particular house using its address.

In a list the only way to find a particular element is to follow along the chain of elements. It's more like human relations. Maybe you ask Harry where Bob is. Harry doesn't know, but he thinks Jane might know, so you go and ask Jane. Jane saw Bob leave the office with Sally, so you call Sally's cell phone. She dropped Bob off at Peter's office, so...but you get the idea. You can't access a data item directly; you must use relationships between the items to locate it. You start with the first item, go to the second, then the third, until you find what you're looking for.

The LinkedList Workshop Applet

The LinkedList Workshop applet provides three list operations. You can insert a new data item, search for a data item with a specified key, and delete a data item with a specified key. These operations are the same ones we explored in the Array Workshop applet in [Chapter 2](#); they're suitable for a general-purpose database application.

Figure 5.3 shows how the LinkedList Workshop applet looks when it's started up. Initially there are 13 links on the list.

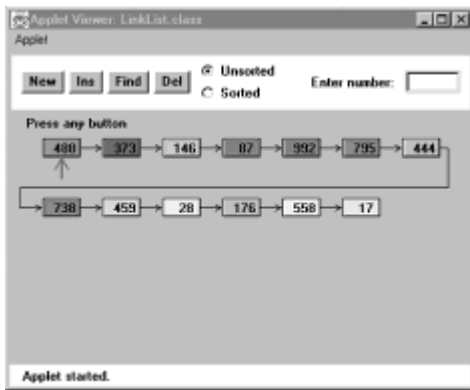

Figure 5.3: The LinkList Workshop applet

Insert

If you think 13 is an unlucky number, you can insert a new link. Click on the **Ins** button, and you'll be prompted to enter a key value between 0 and 999. Subsequent presses will generate a link with this data in it, as shown in Figure 5.4.

In this version of a linked list, new links are always inserted at the beginning of the list. This is the simplest approach, although it's also possible to insert links anywhere in the list, as we'll see later.

A final press on **Ins** will redraw the list so the newly inserted link lines up with the other links. This redrawing doesn't represent anything happening in the program itself, it just makes the display look neater.

Find

The **Find** button allows you find a link with a specified key value. When prompted, type in the value of an existing link, preferably one somewhere in the middle of the list. As you continue to press the button, you'll see the red arrow move along the list, looking for the link. A message informs you when it finds it. If you type a nonexistent key value, the arrow will search all the way to the end of the list before reporting that the item can't be found.

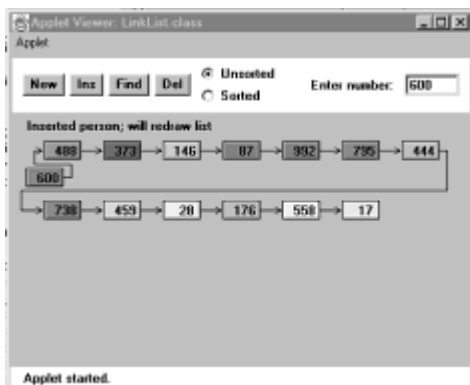

Figure 5.4: A new link being inserted

Delete

You can also delete a key with a specified value. Type in the value of an existing link, and

repeatedly press Del. Again the arrow will move along the list, looking for the link. When it finds it, it simply removes it and connects the arrow from the previous link straight across to the following link. This is how links are removed: the reference to the preceding link is changed to point to the following link.

A final keypress redraws the picture, but again this just provides evenly spaced links for aesthetic reasons; the length of the arrows doesn't correspond to anything in the program.

Unsorted and Sorted

The LinkList Workshop applet can create both unsorted and sorted lists. Unsorted is the default. We'll show how to use the applet for sorted lists when we discuss them later in this chapter.

A Simple Linked List

Our first example program, `linkList.java`, demonstrates a simple linked list. The only operations allowed in this version of a list are

- Inserting an item at the beginning of the list
- Deleting the item at the beginning of the list
- Iterating through the list to display its contents

These operations are fairly easy to carry out, so we'll start with them. (As we'll see later, these operations are also all you need to use a linked list as the basis for a stack.)

Before we get to the complete `linkList.java` program, we'll look at some important parts of the `Link` and `LinkList` classes.

The Link Class

You've already seen the data part of the `Link` class. Here's the complete class definition:

```
class Link
{
    public int iData;           // data item
    public double dData;       // data item
    public Link next;          // next link in list

// -----
-
    public Link(int id, double dd) // constructor
    {
iData = id;                    // initialize data
        dData = dd;            // ('next' is automatically
    }                          // set to null)

// -----
-
    public void displayLink()    // display ourself
    {
        System.out.print("{ " + iData + ", " + dData + " } ");
    }
}
```

```

    }

} // end class Link

```

In addition to the data, there's a constructor and a method, `displayLink()`, that displays the link's data in the format `{22, 33.9}`. Object purists would probably object to naming this method `displayLink()`, arguing that it should be simply `display()`. This would be in the spirit of polymorphism, but it makes the listing somewhat harder to understand when you see a statement like

```
current.display();
```

and you've forgotten whether `current` is a `Link` object, a `LinkedList` object, or something else.

The constructor initializes the data. There's no need to initialize the `next` field, because it's automatically set to `null` when it's created. (Although it could be set to `null` explicitly, for clarity.) The `null` value means it doesn't refer to anything, which is the situation until the link is connected to other links.

We've made the storage type of the `Link` fields (`iData` and so on) `public`. If they were `private` we would need to provide public methods to access them, which would require extra code, thus making the listing longer and harder to read. Ideally, for security we would probably want to restrict `Link`-object access to methods of the `LinkedList` class. However, without an inheritance relationship between these classes, that's not very convenient. We could use the default access specifier (no keyword) to give the data *package access* (access restricted to classes in the same directory) but that has no effect in these demo programs, which only occupy one directory anyway. The `public` specifier at least makes it clear that this data isn't private.

The `LinkedList` Class

The `LinkedList` class contains only one data item: a reference to the first link on the list. This reference is called `first`. It's the only permanent information the list maintains about the location of any of the links. It finds the other links by following the chain of references from `first`, using each link's `next` field.

```

class LinkedList
{
    private Link first;           // ref to first link on list

// -----
-
    public void LinkedList()      // constructor
    {
        first = null;           // no items on list yet
    }

// -----
-
    public boolean isEmpty()      // true if list is empty
    {
        return (first==null);
    }
}

```

```
// -----
-
... // other methods go here
}
```

The constructor for `LinkedList` sets `first` to `null`. This isn't really necessary because as we noted, references are set to `null` automatically when they're created. However, the explicit constructor makes it clear that this is how `first` begins.

When `first` has the value `null`, we know there are no items on the list. If there were any items, `first` would contain a reference to the first one. The `isEmpty()` method uses this fact to determine whether the list is empty.

The `insertFirst()` Method

The `insertFirst()` method of `LinkedList` inserts a new link at the beginning of the list. This is the easiest place to insert a link, because `first` already points to the first link. To insert the new link, we need only set the `next` field in the newly created link to point to the old first link, and then change `first` so it points to the newly created link. This is shown in [Figure 5.5](#).

In `insertFirst()` we begin by creating the new link using the data passed as arguments. Then we change the link references as we just noted.

```

// insert at start of list
public void insertFirst(int id, double dd)
{
    // make new link
    Link newLink = new Link(id, dd);
    newLink.next = first; // newLink --> old first
    first = newLink;    // first --> newLink
}

```

The arrows `-->` in the comments in the last two statements mean that a link (or the `first` field) connects to the next (downstream) link. (In doubly linked lists we'll see upstream connections as well, symbolized by `<--` arrows.) Compare these two statements with [Figure 5.5](#). Make sure you understand how the statements cause the links to be changed, as shown in the figure. This kind of reference-manipulation is the heart of linked list algorithms.

The `deleteFirst()` Method

The `deleteFirst()` method is the reverse of `insertFirst()`. It disconnects the first link by rerouting `first` to point to the second link. This second link is found by looking at the `next` field in the first link.

```

// delete first item
public Link deleteFirst()
{
    // (assumes list not empty)
    Link temp = first; // save reference to link
    first = first.next; // delete it: first-->old next
    return temp;      // return deleted link
}

```

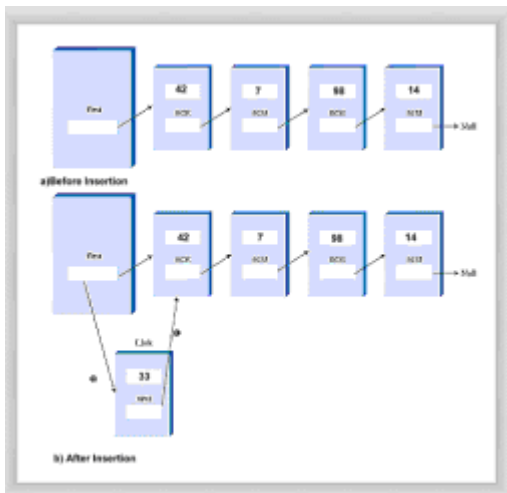

Figure 5.5: Inserting a new link

The second statement is all you need to remove the first link from the list. We choose to also return the link, for the convenience of the user of the linked list, so we save it in `temp` before deleting it, and return the value of `temp`. Figure 5.6 shows how `first` is rerouted to delete the object.

In C++ and similar languages, you would need to worry about deleting the link itself after it was disconnected from the list. It's in memory somewhere, but now nothing refers to it. What will become of it? In Java, the garbage collection process will destroy it at some point in the future; it's not your responsibility.

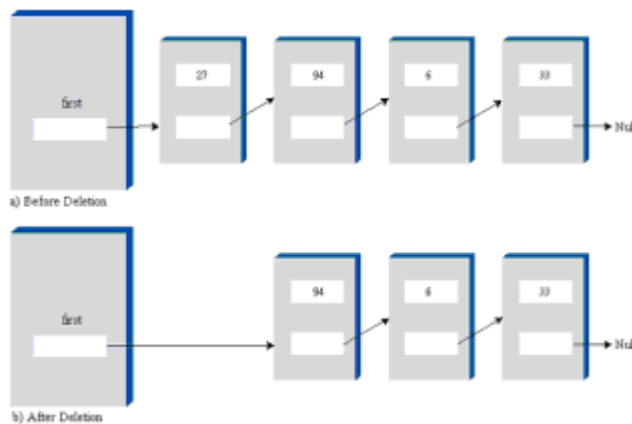

Figure 5.6: Deleting a link

Notice that the `deleteFirst()` method assumes the list is not empty. Before calling it, your program should verify this with the `isEmpty()` method.

The `displayList()` Method

To display the list, you start at `first` and follow the chain of references from link to link. A variable `current` points to (or technically *refers* to) each link in turn. It starts off pointing to `first`, which holds a reference to the first link. The statement

```
current = current.next;
```

changes `current` to point to the next link, because that's what's in the `next` field in each link. Here's the entire `displayList()` method:

```
public void displayList()
{
    System.out.print("List (first-->last): ");
    Link current = first;      // start at beginning of list
    while(current != null)    // until end of list,
    {
        current.displayLink(); // print data
        current = current.next; // move to next link
    }
    System.out.println("");
}
}
```

The end of the list is indicated by the `next` field in the last link pointing to `null` rather than another link. How did this field get to be `null`? It started that way when the link was created and was never given any other value because it was always at the end of the list. The `while` loop uses this condition to terminate itself when it reaches the end of the list. Figure 5.7 shows how `current` steps along the list.

At each link, the `displayList()` method calls the `displayLink()` method to display the data in the link.

The `linkList.java` Program

Listing 5.1 shows the complete `linkList.java` program. You've already seen all the components except the `main()` routine.

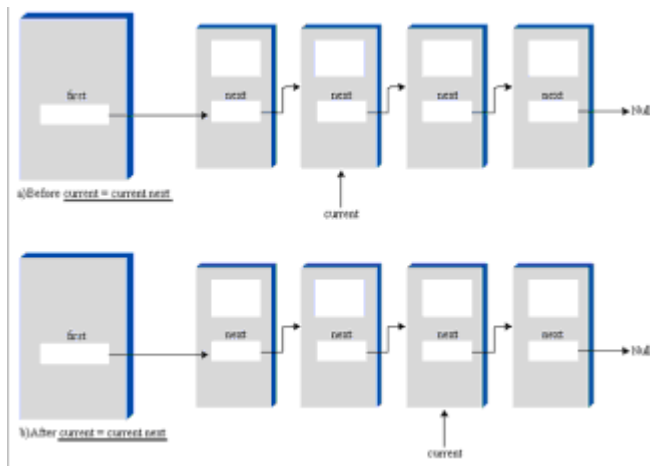

Figure 5.7: Stepping along the list

Listing 5.1 The `linkList.java` Program

```
// linkList.java
// demonstrates linked list
// to run this program: C>java LinkListApp
////////////////////////////////////
class Link
```

```

    {
    public int iData;           // data item (key)
    public double dData;       // data item
    public Link next;          // next link in list

// -----
-
    public Link(int id, double dd) // constructor
    {
iData = id;                   // initialize data
    dData = dd;                // ('next' is automatically
    }                           // set to null)

// -----
-
    public void displayLink()     // display ourself
    {
        System.out.print("{ " + iData + ", " + dData + " } ");
    }
    } // end class Link

////////////////////////////////////

class LinkList
    {
    private Link first;           // ref to first link on list

// -----
-
    public LinkList()             // constructor
    {
        first = null;            // no items on list yet
    }

// -----
-
    public boolean isEmpty()      // true if list is empty
    {
        return (first==null);
    }

// -----
-
                                // insert at start of list
    public void insertFirst(int id, double dd)
    {
                                // make new link
        Link newLink = new Link(id, dd);
        newLink.next = first;    // newLink --> old first
        first = newLink;        // first --> newLink
    }

// -----
-

```

```

    public Link deleteFirst()           // delete first item
    {                                   // (assumes list not empty)
        Link temp = first;             // save reference to link
        first = first.next;           // delete it: first-->old
next
        return temp;                  // return deleted link
    }

// -----
-
    public void displayList()
    {
        System.out.print("List (first-->last): ");
        Link current = first;         // start at beginning of list
        while(current != null)        // until end of list,
        {
            current.displayLink();     // print data
            current = current.next;    // move to next link
        }
        System.out.println("");
    }

// -----
-
} // end class LinkList

////////////////////////////////////

class LinkListApp
{
    public static void main(String[] args)
    {
        LinkList theList = new LinkList(); // make new list

        theList.insertFirst(22, 2.99);    // insert four items
        theList.insertFirst(44, 4.99);
        theList.insertFirst(66, 6.99);
        theList.insertFirst(88, 8.99);

        theList.displayList();            // display list

        while( !theList.isEmpty() )      // until it's empty,
        {
            Link aLink = theList.deleteFirst(); // delete link
            System.out.print("Deleted ");      // display it
            aLink.displayLink();
            System.out.println("");
        }
        theList.displayList();            // display list
    } // end main()

} // end class LinkListApp

```

In `main()` we create a new list, insert four new links into it with `insertFirst()`, and display it. Then, in the `while` loop, we remove the items one by one with `deleteFirst()` until the list is empty. The empty list is then displayed. Here's the output from `linkList.java`:

```
List (first-->last): {88, 8.99} {66, 6.99} {44, 4.99} {22,
2.99}
Deleted {88, 8.99}
Deleted {66, 6.99}
Deleted {44, 4.99}
Deleted {22, 2.99}
List (first-->last):
```

Finding and Deleting Specified Links

Our next example program adds methods to search a linked list for a data item with a specified key value, and to delete an item with a specified key value. These, along with insertion at the start of the list, are the same operations carried out by the `LinkList Workshop` applet. The complete `linkList2.java` program is shown in Listing 5.2.

Listing 5.2 The `linkList2.java` Program

```
// linkList2.java
// demonstrates linked list
// to run this program: C>java LinkList2App
////////////////////////////////////
class Link
{
    public int iData;           // data item (key)
    public double dData;       // data item
    public Link next;          // next link in list

// -----
-
    public Link(int id, double dd) // constructor
    {
        iData = id;
        dData = dd;
    }

// -----
-
    public void displayLink()      // display ourself
    {
        System.out.print("{ " + iData + ", " + dData + " } ");
    }
} // end class Link

////////////////////////////////////

class LinkList
{
    private Link first;           // ref to first link on list
```

```

// -----
-
public LinkList()           // constructor
{
    first = null;           // no links on list yet
}

// -----
-
public void insertFirst(int id, double dd)
{
    // make new link
    Link newLink = new Link(id, dd);
    newLink.next = first;   // it points to old first
link
    first = newLink;       // now first points to this
}

// -----
-
public Link find(int key)   // find link with given key
{
    // (assumes non-empty list)
    Link current = first;   // start at 'first'
    while(current.iData != key) // while no match,
    {
        if(current.next == null) // if end of list,
            return null;         // didn't find it
        else // not end of list,
            current = current.next; // go to next link
    }
    return current;        // found it
}

// -----
-
public Link delete(int key) // delete link with given key
{
    // (assumes non-empty list)
    Link current = first;   // search for link
    Link previous = first;
    while(current.iData != key)
    {
        if(current.next == null)
            return null;    // didn't find it
        else
        {
            previous = current; // go to next link
            current = current.next;
        }
    }
    // found it
    if(current == first)
        first = first.next; // if first link,
    // change first
    else // otherwise,
        previous.next = current.next; // bypass it
    return current;
}

```

```

    }

// -----
-
public void displayList()      // display the list
{
    System.out.print("List (first-->last): ");
    Link current = first;      // start at beginning of list
    while(current != null)     // until end of list,
    {
        current.displayLink(); // print data
        current = current.next; // move to next link
    }
    System.out.println("");
}

// -----
-
} // end class LinkList

////////////////////////////////////

class LinkList2App
{
    public static void main(String[] args)
    {
        LinkList theList = new LinkList(); // make list

        theList.insertFirst(22, 2.99);     // insert 4 items
        theList.insertFirst(44, 4.99);
        theList.insertFirst(66, 6.99);
        theList.insertFirst(88, 8.99);

        theList.displayList();             // display list

        Link f = theList.find(44);         // find item
        if( f != null)
            System.out.println("Found link with key " + f.iData);
        else
            System.out.println("Can't find link");

        Link d = theList.delete(66);       // delete item
        if( d != null )
            System.out.println("Deleted link with key " +
d.iData);
        else
            System.out.println("Can't delete link");
        theList.displayList();             // display list
    } // end main()

} // end class LinkList2App

```

The `main()` routine makes a list, inserts four items, and displays the resulting list. It then searches for the item with key 44, deletes the item with key 66, and displays the list

again. Here's the output:

```
List (first-->last): {88, 8.99} {66, 6.99} {44, 4.99} {22, 2.99}
Found link with key 44
Deleted link with key 66
List (first-->last): {88, 8.99} {44, 4.99} {22, 2.99}
```

The find() Method

The `find()` method works much like the `displayList()` method seen in the last program. The reference `current` initially points to `first`, and then steps its way along the links by setting itself repeatedly to `current.next`. At each link, `find()` checks if that link's key is the one it's looking for. If it is, it returns with a reference to that link. If it reaches the end of the list without finding the desired link, it returns `null`.

The delete() Method

The `delete()` method is similar to `find()` in the way it searches for the link to be deleted. However, it needs to maintain a reference not only to the current link (`current`), but to the link preceding the current link (`previous`). This is because, if it deletes the current link, it must connect the preceding link to the following link, as shown in [Figure 5.8](#). The only way to tell where the preceding link is, is to maintain a reference to it.

At each cycle through the `while` loop, just before `current` is set to `current.next`, `previous` is set to `current`. This keeps it pointing at the link preceding `current`.

To delete the current link once it's found, the `next` field of the previous link is set to the next link. A special case arises if the current link is the first link because the first link is pointed to by the `LinkedList`'s `first` field and not by another link. In this case the link is deleted by changing `first` to point to `first.next`, as we saw in the last program with the `deleteFirst()` method. Here's the code that covers these two possibilities:

```
                                // found it

if(current == first)           // if first link,
    first = first.next;        //   change first

else                            // otherwise,

    previous.next = current.next; //   bypass link
```

Other Methods

We've seen methods to insert and delete items at the start of a list and to find a specified item and delete a specified item. You can imagine other useful list methods. For example, an `insertAfter()` method could find a link with a specified key value and insert a new link following it. We'll see such a method when we talk about list iterators at the end of this chapter.

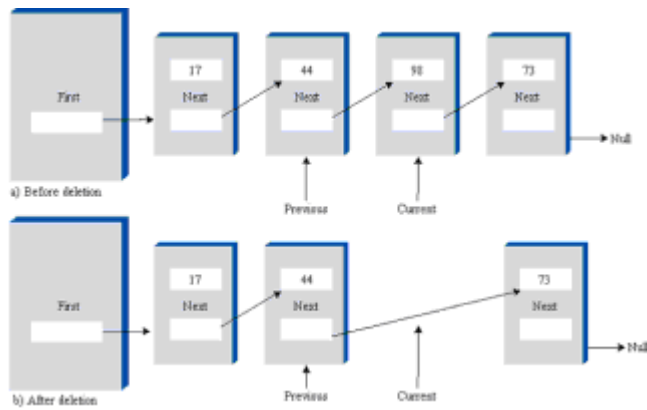

Figure 5.8: Deleting a specified link

Double-Ended Lists

A double-ended list is similar to an ordinary linked list, but it has one additional feature: a reference to the last link as well as to the first. Figure 5.9 shows what this looks like.

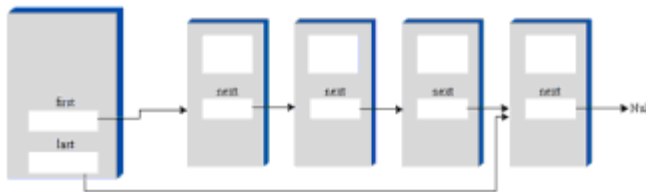

Figure 5.9: A double-ended list

The reference to the last link permits you to insert a new link directly at the end of the list as well as at the beginning. Of course you can insert a new link at the end of an ordinary single-ended list by iterating through the entire list until you reach the end, but this is inefficient.

Access to the end of the list as well as the beginning makes the double-ended list suitable for certain situations that a single-ended list can't handle efficiently. One such situation is implementing a queue; we'll see how this works in the next section.

Listing 5.3 contains the `firstLastList.java` program, which demonstrates a double-ended list. (Incidentally, don't confuse the double-ended list with the doubly linked list, which we'll explore later in this chapter.)

Listing 5.3 The `firstLastList.java` Program

```
// firstLastList.java
// demonstrates list with first and last references
// to run this program: C>java FirstLastApp
////////////////////////////////////
class Link
{
    public double dData;           // data item
    public Link next;             // next link in list

// -----
-

```

```

public Link(double d)                // constructor
    { dData = d; }

// -----
-
public void displayLink()            // display this link
    { System.out.print(dData + " "); }

// -----
-
} // end class Link

////////////////////////////////////

class FirstLastList
{
    private Link first;                // ref to first link
    private Link last;                // ref to last link

// -----
-
public FirstLastList()                // constructor
    {
        first = null;                // no links on list yet
        last = null;
    }

// -----
-
public boolean isEmpty()                // true if no links
    { return first==null; }

// -----
-
public void insertFirst(double dd) // insert at front of
list
    {
        Link newLink = new Link(dd); // make new link

        if( isEmpty() )                // if empty list,
            last = newLink;            // newLink <-- last
        newLink.next = first;          // newLink --> old first
        first = newLink;               // first --> newLink
    }

// -----
-
public void insertLast(double dd) // insert at end of list
    {
        Link newLink = new Link(dd); // make new link

        if( isEmpty() )                // if empty list,
            first = newLink;           // first --> newLink
        else
            last.next = newLink;       // old last --> newLink
    }
}

```

```

        last = newLink;                // newLink <-- last
    }

// -----
-
    public double deleteFirst()        // delete first link
    {                                  // (assumes non-empty
list)
        double temp = first.dData;    // save the data
        if(first.next == null)        // if only one item
            last = null;               // null <-- last
        first = first.next;           // first --> old next
        return temp;
    }

// -----
-
    public void displayList()
    {
        System.out.print("List (first-->last): ");
        Link current = first;         // start at beginning
        while(current != null)        // until end of list,
        {
            current.displayLink();    // print data
            current = current.next;    // move to next link
        }
        System.out.println("");
    }

// -----
-
    } // end class FirstLastList

////////////////////////////////////

class FirstLastApp
{
    public static void main(String[] args)
    {
        // make a new list
        FirstLastList theList = new FirstLastList();

        theList.insertFirst(22);      // insert at front
        theList.insertFirst(44);
        theList.insertFirst(66);

        theList.insertLast(11);       // insert at rear
        theList.insertLast(33);
        theList.insertLast(55);

        theList.displayList();        // display the list

        theList.deleteFirst();        // delete first two items
        theList.deleteFirst();
    }
}

```

```

    theList.displayList();          // display again
} // end main()

} // end class FirstLastApp

```

For simplicity, in this program we've reduced the number of data items in each link from two to one. This makes it easier to display the link contents. (Remember that in a serious program there would be many more data items, or a reference to another object containing many data items.)

This program inserts three items at the front of the list, inserts three more at the end, and displays the resulting list. It then deletes the first two items and displays the list again. Here's the output:

```

List (first-->last): 66 44 22 11 33 55
List (first-->last): 22 11 33 55

```

Notice how repeated insertions at the front of the list reverse the order of the items, while repeated insertions at the end preserve the order.

The double-ended list class is called the `FirstLastList`. As discussed, it has two data items, `first` and `last`, which point to the first item and the last item in the list. If there is only one item in the list, then both `first` and `last` point to it, and if there are no items, they are both `null`.

The class has a new method, `insertLast()`, that inserts a new item at the end of the list. This involves modifying `last.next` to point to the new link, and then changing `last` to point to the new link, as shown in Figure 5.10.

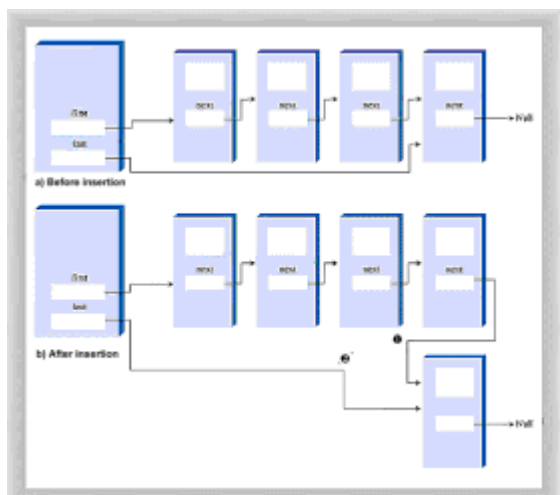

Figure 5.10: Insertion at the end of a list

The insertion and deletion routines are similar to those in a single-ended list. However, both insertion routines must watch out for the special case when the list is empty prior to the insertion. That is, if `isEmpty()` is true, then `insertFirst()` must set `last` to the new link, and `insertLast()` must set `first` to the new link.

If inserting at the beginning with `insertFirst()`, `first` is set to point to the new link, although when inserting at the end with `insertLast()`, `last` is set to point to the new link. Deleting from the start of the list is also a special case if it's the last item on the list: `last` must be set to point to `null` in this case.

Unfortunately, making a list double-ended doesn't help you to delete the last link, because there is still no reference to the next-to-last link, whose `next` field would need to be changed to `null` if the last link were deleted. To conveniently delete the last link, you would need a doubly linked list, which we'll look at soon. (Of course, you could also traverse the entire list to find the last link, but that's not very efficient.)

Linked-List Efficiency

Insertion and deletion at the beginning of a linked list are very fast. They involve changing only one or two references, which takes $O(1)$ time.

Finding, deleting, or insertion next to a specific item requires searching through, on the average, half the items in the list. This requires $O(N)$ comparisons. An array is also $O(N)$ for these operations, but the linked list is nevertheless faster because nothing needs to be moved when an item is inserted or deleted. The increased efficiency can be significant, especially if a copy takes much longer than a comparison.

Of course, another important advantage of linked lists over arrays is that the linked list uses exactly as much memory as it needs, and can expand to fill all of the available memory. The size of an array is fixed when it's created; this usually leads to inefficiency because the array is too large, or to running out of room because the array is too small. Vectors, which are expandable arrays, may solve this problem to some extent, but they usually expand in fixed-sized increments (such as doubling the size of the array whenever it's about to overflow). This is still not as efficient a use of memory as a linked list.

Abstract Data Types

In this section we'll shift gears and discuss a topic that's more general than linked lists: Abstract Data Types (ADTs). What is an ADT? Roughly speaking, it's a way of looking at a data structure: focusing on what it does, and ignoring how it does it.

Stacks and queues are examples of ADTs. We've already seen that both stacks and queues can be implemented using arrays. Before we return to a discussion of ADTs, let's see how stacks and queues can be implemented using linked lists. This will demonstrate the "abstract" nature of stacks and queues: how they can be considered separately from their implementation.

A Stack Implemented by a Linked List

When we created a stack in the [last chapter](#), we used an ordinary Java array to hold the stack's data. The stack's `push()` and `pop()` operations were actually carried out by array operations such as

```
arr[++top] = data;
```

and

```
data = arr[top--];
```

which insert data into, and take it out of, an array.

We can also use a linked list to hold a stack's data. In this case the `push()` and `pop()` operations would be carried out by operations like

```
theList.insertFirst(data)
```

and

```
data = theList.deleteFirst()
```

The user of the stack class calls `push()` and `pop()` to insert and delete items, without knowing, or needing to know, whether the stack is implemented as an array or as a linked list. Listing 5.4 shows how a stack class called `LinkStack` can be implemented using the `LinkList` class instead of an array. (Object purists would argue that the name `LinkStack` should be simply `Stack`, because users of this class shouldn't need to know that it's implemented as a list.)

Listing 5.4 The `linkStack()` Program

```
// linkStack.java
// demonstrates a stack implemented as a list

// to run this program: C>java LinkStackApp
import java.io.*;                // for I/O
////////////////////////////////////
class Link
{
    public double dData;          // data item
    public Link next;            // next link in list

// -----
-
    public Link(double dd)        // constructor
        { dData = dd; }

// -----
-
    public void displayLink()     // display ourself
        { System.out.print(dData + " "); }
} // end class Link

////////////////////////////////////

class LinkList
{
    private Link first;          // ref to first item on list

// -----
-
    public LinkList()            // constructor
        { first = null; }        // no items on list yet

// -----
-
    public boolean isEmpty()      // true if list is empty
        { return (first==null); }

// -----
-
    public void insertFirst(double dd) // insert at start of
list
```

```

        {
            // make new link
            Link newLink = new Link(dd);
            newLink.next = first;    // newLink --> old first
            first = newLink;        // first --> newLink
        }

// -----
-
    public double deleteFirst()    // delete first item
    {
        // (assumes list not empty)
        Link temp = first;        // save reference to link
        first = first.next;      // delete it: first-->old
next
        return temp.dData;        // return deleted link
    }

// -----
-
    public void displayList()
    {
        Link current = first;    // start at beginning of list
        while(current != null)   // until end of list,
        {
            current.displayLink(); // print data
            current = current.next; // move to next link
        }
        System.out.println("");
    }

// -----
-
} // end class LinkList

////////////////////////////////////

class LinkStack
{
    private LinkList theList;

//-----
-
    public LinkStack()           // constructor
    {
        theList = new LinkList();
    }

//-----
-
    public void push(double j)   // put item on top of stack
    {
        theList.insertFirst(j);
    }

//-----
-

```

```

    public double pop()          // take item from top of
stack
    {
        return theList.deleteFirst();
    }

//-----
-
    public boolean isEmpty()    // true if stack is empty
    {
        return ( theList.isEmpty() );
    }

//-----
-
    public void displayStack()
    {
        System.out.print("Stack (top-->bottom): ");
        theList.displayList();
    }

//-----
-
} // end class LinkStack

////////////////////////////////////

class LinkStackApp
{
    public static void main(String[] args) throws IOException
    {
        LinkStack theStack = new LinkStack(); // make stack

        theStack.push(20);                    // push items
        theStack.push(40);

        theStack.displayStack();              // display stack

        theStack.push(60);                    // push items
        theStack.push(80);

        theStack.displayStack();              // display stack

        theStack.pop();                       // pop items
        theStack.pop();

        theStack.displayStack();              // display stack
    } // end main()

} // end class LinkStackApp

```

The `main()` routine creates a stack object, pushes two items on it, displays the stack, pushes two more items, and displays it again. Finally it pops two items and displays the stack again. Here's the output:

```

Stack (top-->bottom): 40 20
Stack (top-->bottom): 80 60 40 20
Stack (top-->bottom): 40 20

```

Notice the overall organization of this program. The `main()` routine in the `LinkStackApp` class relates only to the `LinkStack` class. The `LinkStack` class relates only to the `LinkList` class. There's no communication between `main()` and the `LinkList` class.

More specifically, when a statement in `main()` calls the `push()` operation in the `LinkStack` class, this method in turn calls `insertFirst()` in the `LinkList` class to actually insert data. Similarly, `pop()` calls `deleteFirst()` to delete an item, and `displayStack()` calls `displayList()` to display the stack. To the class user, writing code in `main()`, there is no difference between using the list-based `LinkStack` class and using the array-based `stack` class from the `Stack.java` program in [Chapter 4](#).

A Queue Implemented by a Linked List

Here's a similar example of an ADT implemented with a linked list. Listing 5.5 shows a queue implemented as a double-ended linked list.

Listing 5.5 The `linkQueue()` Program

```

// linkQueue.java
// demonstrates queue implemented as double-ended list
// to run this program: C>java LinkQueueApp
import java.io.*;           // for I/O
////////////////////////////////////
class Link
{
    public double dData;      // data item
    public Link next;        // next link in list

// -----
-
    public Link(double d)    // constructor
        { dData = d; }

// -----
-
    public void displayLink() // display this link
        { System.out.print(dData + " "); }

// -----
-
} // end class Link

////////////////////////////////////

class FirstLastList
{
    private Link first;      // ref to first item
    private Link last;      // ref to last item

```

```

// -----
-
public FirstLastList()           // constructor
{
    first = null;                // no items on list yet
    last = null;
}

// -----
-
public boolean isEmpty()         // true if no links
{ return first==null; }

// -----
-
public void insertLast(double dd) // insert at end of list
{
    Link newLink = new Link(dd); // make new link
    if( isEmpty() )             // if empty list,
        first = newLink;        // first --> newLink
    else
        last.next = newLink;    // old last --> newLink
    last = newLink;             // newLink <-- last
}

// -----
-
public double deleteFirst()     // delete first link
{                               // (assumes non-empty
list)
    double temp = first.dData;
    if(first.next == null)      // if only one item
        last = null;           // null <-- last
    first = first.next;         // first --> old next
    return temp;
}

// -----
-
public void displayList()
{
    Link current = first;       // start at beginning
    while(current != null)      // until end of list,
    {
        current.displayLink(); // print data
        current = current.next; // move to next link
    }
    System.out.println("");
}

// -----
-
} // end class FirstLastList

////////////////////////////////////

```

```

class LinkQueue
{
    private FirstLastList theList;

//-----
-
    public LinkQueue()          // constructor
    {
        theList = new FirstLastList(); // make a 2-ended list
    }

//-----
-
    public boolean isEmpty()    // true if queue is empty
    {
        return theList.isEmpty();
    }

//-----
-
    public void insert(double j) // insert, rear of queue
    {
        theList.insertLast(j);
    }

//-----
-
    public double remove()      // remove, front of queue
    {
        return theList.deleteFirst();
    }

//-----
-
    public void displayQueue()
    {
        System.out.print("Queue (front-->rear): ");
        theList.displayList();
    }

//-----
-
    } // end class LinkQueue

////////////////////////////////////

class LinkQueueApp
{
    public static void main(String[] args) throws IOException
    {
        LinkQueue theQueue = new LinkQueue();
        theQueue.insert(20);          // insert items
        theQueue.insert(40);
    }
}

```

```

        theQueue.displayQueue();           // display queue

        theQueue.insert(60);              // insert items
        theQueue.insert(80);

        theQueue.displayQueue();         // display queue

        theQueue.remove();               // remove items
        theQueue.remove();

        theQueue.displayQueue();         // display queue
    } // end main()

} // end class LinkQueueApp

```

The program creates a queue, inserts two items, inserts two more items, and removes two items; following each of these operations the queue is displayed. Here's the output:

```

Queue (front-->rear): 20 40
Queue (front-->rear): 20 40 60 80
Queue (front-->rear): 60 80

```

Here the methods `insert()` and `remove()` in the `LinkQueue` class are implemented by the `insertLast()` and `deleteFirst()` methods of the `FirstLastList` class. We've substituted a linked list for the array used to implement the queue in the `Queue` program of [Chapter 4](#).

The `LinkStack` and `LinkQueue` programs emphasize that stacks and queues are conceptual entities, separate from their implementations. A stack can be implemented equally well by an array or by a linked list. What's important about a stack is the `push()` and `pop()` operations and how they're used; it's not the underlying mechanism used to implement these operations.

When would you use a linked list as opposed to an array as the implementation of a stack or queue? One consideration is how accurately you can predict the amount of data the stack or queue will need to hold. If this isn't clear, the linked list gives you more flexibility than an array. Both are fast, so that's probably not a major consideration.

Data Types and Abstraction

Where does the term *Abstract Data Type* come from? Let's look at the "data type" part of it first, and then return to "abstract."

Data Types

The phrase "data type" covers a lot of ground. It was first applied to built-in types such as `int` and `double`. This is probably what you first think of when you hear the term.

When you talk about a primitive type, you're actually referring to two things: a data item with certain characteristics, and permissible operations on that data. For example, type `int` variables in Java can have whole-number values between $-2,147,483,648$ and $+2,147,483,647$, and the operators `+`, `-`, `*`, `/`, and so on can be applied to them. The data type's permissible operations are an inseparable part of its identity; understanding the type means understanding what operations can be performed on it.

With the advent of object-oriented programming, it became possible to create your own

data types using classes. Some of these data types represent numerical quantities that are used in ways similar to primitive types. You can, for example, define a class for time (with fields for hours, minutes, seconds), a class for fractions (with numerator and denominator fields), and a class for extra-long numbers (characters in a string represent the digits). All these can be added and subtracted like `int` and `double`, except that in Java you must use methods with functional notation like `add()` and `sub()` rather than operators like `+` and `-`.

The phrase "data type" seems to fit naturally with such quantity-oriented classes. However, it is also applied to classes that don't have this quantitative aspect. In fact, *any* class represents a data type, in the sense that a class comprises data (fields) and permissible operations on that data (methods).

By extension, when a data storage structure like a stack or queue is represented by a class, it too can be referred to as a data type. A stack is different in many ways from an `int`, but they are both defined as a certain arrangement of data and a set of operations on that data.

Abstraction

The word *abstract* means "considered apart from detailed specifications or implementation." An abstraction is the essence or important characteristics of something. The office of President, for example, is an abstraction, considered apart from the individual who happens to occupy that office. The powers and responsibilities of the office remain the same, while individual office-holders come and go.

In object-oriented programming, then, an abstract data type is a class considered without regard to its implementation. It's a description of the data in the class (fields), a list of operations (methods) that can be carried out on that data, and instructions on how to use these operations. Specifically excluded are the details of how the methods carry out their tasks. As a class user, you're told what methods to call, how to call them, and the results you can expect, but not how they work.

The meaning of *abstract data type* is further extended when it's applied to data structures like stacks and queues. As with any class, it means the data and the operations that can be performed on it, but in this context even the fundamentals of how the data is stored become invisible to the user. Users not only don't know how the methods work, they also don't know what structure is used to store the data.

For the stack, the user knows that `push()` and `pop()` (and perhaps a few other methods) exist and how they work. The user doesn't (at least not usually) need to know how `push()` and `pop()` work, or whether data is stored in an array, a linked list, or some other data structure like a tree.

The Interface

An ADT specification is often called an *interface*. It's what the class user sees; usually its public methods. In a stack class, `push()` and `pop()` and similar methods form the interface.

ADT Lists

Now that we know what an abstract data type is, we can mention another one: the *list*. A list (sometimes called a linear list) is a group of items arranged in a linear order. That is, they're lined up in a certain way, like beads on a string or houses on a street. Lists support certain fundamental operations. You can insert an item, delete an item, and usually read an item from a specified location (the third item, say).

Don't confuse the ADT list with the linked list we've been discussing in this chapter. A list

is defined by its interface: the specific methods used to interact with it. This interface can be implemented by various structures, including arrays and linked lists. The list is an abstraction of such data structures.

ADTs as a Design Tool

The ADT concept is a useful aid in the software design process. If you need to store data, start by considering the operations that need to be performed on that data. Do you need access to the last item inserted? The first one? An item with a specified key? An item in a certain position? Answering such questions leads to the definition of an ADT. Only after the ADT is completely defined should you worry about the details of how to represent the data and how to code the methods that access the data.

By decoupling the specification of the ADT from the implementation details, you can simplify the design process. You also make it easier to change the implementation at some future time. If the users relate only to the ADT interface, you should be able to change the implementation without "breaking" the user's code.

Of course, once the ADT has been designed, the underlying data structure must be carefully chosen to make the specified operations as efficient as possible. If you need random access to element N, for example, then the linked-list representation isn't so good because random access isn't an efficient operation for a linked list. You'd be better off with an array.

It's All Relative

Remember that the ADT concept is only a conceptual tool. Data storage structures are not divided cleanly into some that are ADTs and some that are used to implement ADTs. A linked list, for example, doesn't need to be wrapped in a list interface to be useful; it can act as an ADT on its own, or it can be used to implement another data type such as a queue. A linked list can be implemented using an array, and an array-type structure can be implemented using a linked list. What's an ADT and what's a more basic structure must be determined in a given context.

Sorted Lists

In linked lists we've seen thus far, there was no requirement that data be stored in order. However, for certain applications it's useful to maintain the data in sorted order within the list. A list with this characteristic is called a *sorted list*.

In a sorted list, the items are arranged in sorted order by key value. Deletion is often limited to the smallest (or the largest) item in the list, which is at the start of the list, although sometimes `find()` and `delete()` methods, which search through the list for specified links, are used as well.

In general you can use a sorted list in most situations where you use a sorted array. The advantages of a sorted list over a sorted array are speed of insertion (because elements don't need to be moved) and the fact that a list can expand to fill available memory, while an array is limited to a fixed size. However, a sorted list is somewhat more difficult to implement than a sorted array.

Later we'll look at one application for sorted lists: sorting data. A sorted list can also be used to implement a priority queue, although a heap (see [Chapter 12](#)) is a more common implementation.

The LinkList Workshop Applet

The LinkList Workshop applet introduced at the beginning of this chapter demonstrates sorted as well as unsorted lists. Use the New button to create a new list with about 20

links, and when prompted, click on the Sorted button. The result is a list with data in sorted order, as shown in Figure 5.11.

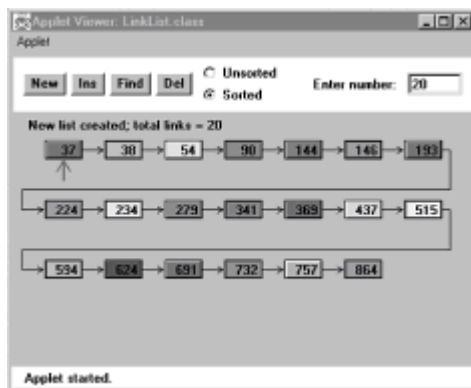

Figure 5.11: The LinkList Workshop applet with a sorted list

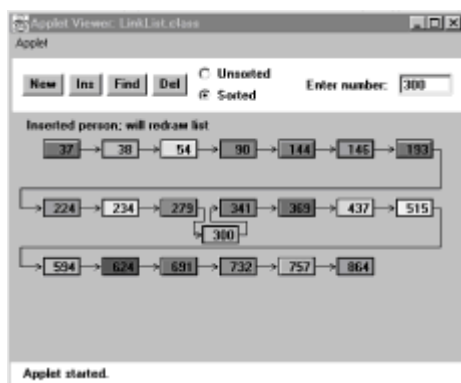

Figure 5.12: A newly inserted link

Use the Ins button to insert a new item. Type in a value that will fall somewhere in the middle of the list. Watch as the algorithm traverses the links, looking for the appropriate insertion place. When it finds it, it inserts the new link, as shown in Figure 5.12.

With the next press of Ins, the list will be redrawn to regularize its appearance. You can also find a specified link using the Find button, and delete a specified link using the Del button.

Java Code to Insert an Item in a Sorted List

To insert an item in a sorted list, the algorithm must first search through the list until it finds the appropriate place to put the item: this is just before the first item that's larger, as shown in Figure 5.12.

Once the algorithm finds where to put it, the item can be inserted in the usual way by changing `next` in the new link to point to the next link, and changing `next` in the previous link to point to the new link. However, there are some special cases to consider: the link might need to be inserted at the beginning of the list, or it might need to go at the end. Let's look at the code:

```
public void insert(double key) // insert in order
{
    Link newLink = new Link(key);    // make new link
```

```

Link previous = null;           // start at first
Link current = first;

                                // until end of list,
while(current != null && key > current.dData)
    {                            // or key > current,
    previous = current;
    current = current.next;      // go to next item
    }
if(previous==null)              // at beginning of list
    first = newLink;            // first --> newLink
else                             // not at beginning
    previous.next = newLink;    // old prev -->
newLink

newLink.next = current;        // newLink --> old currnt

    } // end insert()

```

We need to maintain a `previous` reference as we move along, so we can modify the previous link's `next` field to point to the new link. After creating the new link, we prepare to search for the insertion point by setting `current` to `first` in the usual way. We also set `previous` to `null`; this is important because later we'll use this `null` value to determine whether we're still at the beginning of the list.

The `while` loop is similar to those we've used before to search for the insertion point, but there's an added condition. The loop terminates when the key of the link currently being examined (`current.dData`) is no longer smaller than the key of the link being inserted (`key`); this is the most usual case, where a key is inserted somewhere in the middle of the list.

However, the `while` loop also terminates if `current` is `null`. This happens at the end of the list (the `next` field of the last element is `null`), or if the list is empty to begin with (`first` is `null`).

Once the `while` loop terminates, we may be at the beginning, the middle, or the end of the list, or the list may be empty.

If we're at the beginning or the list is empty, `previous` will be `null`; so we set `first` to the new link. Otherwise, we're in the middle of the list or at the end, and we set `previous.next` to the new link.

In any case we set the new link's `next` field to `current`. If we're at the end of the list, `current` is `null`, so the new link's `next` field is appropriately set to this value.

The `sortedList.java` Program

The `sortedList.java` example shown in Listing 5.6 presents a `SortedList` class with `insert()`, `remove()`, and `displayList()` methods. Only the `insert()` routine is different from its counterpart in nonsorted lists.

Listing 5.6 The `sortedList.java` Program

```

// sortedList.java
// demonstrates sorted list
// to run this program: C>java SortedListApp

```

```

import java.io.*;                                // for I/O
/////////////////////////////////////////////////
class Link
{
    public double dData;                          // data item
    public Link next;                             // next link in list

// -----
-
    public Link(double dd)                       // constructor
        { dData = dd; }

// -----
-
    public void displayLink()                   // display this link
        { System.out.print(dData + " "); }
} // end class Link

/////////////////////////////////////////////////

class SortedList
{
    private Link first;                          // ref to first item on
list

// -----
-
    public SortedList()                         // constructor
        { first = null; }

// -----
-
    public boolean isEmpty()                    // true if no links
        { return (first==null); }

// -----
-
    public void insert(double key) // insert in order
    {
        Link newLink = new Link(key);          // make new link
        Link previous = null;                  // start at first
        Link current = first;

                                                // until end of list,
        while(current != null && key > current.dData)
        {
            // or key > current,
            previous = current;
            current = current.next;             // go to next item
        }
        if(previous==null)                     // at beginning of list
            first = newLink;                   // first --> newLink
        else
            previous.next = newLink;           // old prev --> newLink
        newLink.next = current;                // newLink --> old currnt
    } // end insert()
}

```

```

// -----
-
public Link remove()           // return & delete first link
{                               // (assumes non-empty list)
    Link temp = first;         // save first
    first = first.next;       // delete first
    return temp;              // return value
}

// -----
-
public void displayList()
{
    System.out.print("List (first-->last): ");
    Link current = first;      // start at beginning of list
    while(current != null)    // until end of list,
    {
        current.displayLink(); // print data
        current = current.next; // move to next link
    }
    System.out.println("");
}
} // end class SortedList

////////////////////////////////////

class SortedListApp
{
    public static void main(String[] args)
    {
        // create new list
        SortedList theSortedList = new SortedList();
        theSortedList.insert(20); // insert 2 items
        theSortedList.insert(40);

        theSortedList.displayList(); // display list

        theSortedList.insert(10); // insert 3 more items
        theSortedList.insert(30);
        theSortedList.insert(50);

        theSortedList.displayList(); // display list

        theSortedList.remove(); // remove an item

        theSortedList.displayList(); // display list
    } // end main()
} // end class SortedListApp

```

In `main()` we insert two items with key values 20 and 40. Then we insert three more items, with values 10, 30, and 50. These are inserted at the beginning of the list, in the middle, and at the end; showing that the `insert()` routine correctly handles these special cases. Finally, we remove one item to show removal is always from the front of

the list. After each change the list is displayed. Here's the output from `sortedList.java`:

```
List (first-->last): 20 40
List (first-->last): 10 20 30 40 50
List (first-->last): 20 30 40 50
```

Efficiency of Sorted Linked Lists

Insertion and deletion of arbitrary items in the sorted linked list require $O(N)$ comparisons ($N/2$ on the average) because the appropriate location must be found by stepping through the list. However, the minimum value can be found, or deleted, in $O(1)$ time because it's at the beginning of the list. If an application frequently accesses the minimum item and fast insertion isn't critical, then a sorted linked list is an effective choice.

List Insertion Sort

A sorted list can be used as a fairly efficient sorting mechanism. Suppose you have an array of unsorted data items. If you take the items from the array and insert them one by one into the sorted list, they'll be placed in sorted order automatically. If you then remove them from the list and put them back in the array, they array will be sorted.

It turns out this is substantially more efficient than the more usual insertion sort within an array, described in [Chapter 3](#). This is because fewer copies are necessary. It's still an $O(N^2)$ process, because inserting each item into the sorted list involves comparing a new item with an average of half the items already in the list, and there are N items to insert, resulting in about $N^2/4$ comparisons. However, each item is only copied twice: once from the array to the list, and once from the list to the array. N^2 copies compare favorably with the insertion sort within an array, where there are about N^2 copies.

Listing 5.7 shows the `listInsertionSort.java` program, which starts with an array of unsorted items of type `link`, inserts them into a sorted list (using a constructor), and then removes them and places them back into the array.

Listing 5.7 The `listInsertionSort.java` Program

```
// listInsertionSort.java
// demonstrates sorted list used for sorting
// to run this program: C>java ListInsertionSortApp
import java.io.*;                               // for I/O
/////////////////////////////////////////////////
class Link
{
    public double dData;                          // data item
    public Link next;                             // next link in list

// -----
-
    public Link(double dd)                        // constructor
        { dData = dd; }

// -----
-
} // end class Link
```

```

////////////////////////////////////
class SortedList
{
    private Link first;          // ref to first item on list

// -----
-
    public SortedList()          // constructor (no args)
        { first = null; }

// -----
-
    public SortedList(Link[] linkArr) // constructor (array as
        {                          // argument)
first = null;;                    // initialize list
        for(int j=0; j<linkArr.length; j++) // copy array
            insert( linkArr[j] );          // to list
        }

// -----
-
    public void insert(Link k)      // insert, in order
        {
            Link previous = null;    // start at first
            Link current = first;

                                // until end of list,
            while(current != null && k.dData > current.dData)
                {                  // or key > current,
                    previous = current;
                    current = current.next; // go to next item
                }
            if(previous==null)      // at beginning of list
                first = k;         // first --> k
            else                    // not at beginning
                previous.next = k; // old prev --> k
k.next = current;                 // k --> old current
        } // end insert()

// -----
-
    public Link remove()           // return & delete first link
        {                          // (assumes non-empty list)
            Link temp = first;      // save first
            first = first.next;     // delete first
            return temp;           // return value
        }

// -----
-
    } // end class SortedList

////////////////////////////////////

```



```

class ListInsertionSortApp
{
    public static void main(String[] args)
    {
        int size = 10;
                                // create array of links
        Link[] linkArray = new Link[size];

        for(int j=0; j<size; j++) // fill array with links
        {
                                // random number
            int n = (int)(java.lang.Math.random()*99);
            Link newLink = new Link(n); // make link
            linkArray[j] = newLink;    // put in array
        }

                                // display array contents
        System.out.print("Unsorted array: ");
        for(int j=0; j<size; j++)
            System.out.print( linkArray[j].dData + " " );
        System.out.println("");

                                // create new list,
// initialized with array
        SortedList theSortedList = new SortedList(linkArray);

        for(int j=0; j<size; j++) // links from list to array
            linkArray[j] = theSortedList.remove();

                                // display array contents
        System.out.print("Sorted Array: ");
        for(int j=0; j<size; j++)
            System.out.print(linkArray[j].dData + " ");
        System.out.println("");
    } // end main()

} // end class ListInsertionSortApp

```

This program displays the values in the array before the sorting operation, and again afterward. Here's some sample output:

```

Unsorted array: 59 69 41 56 84 15 86 81 37 35
Sorted array:   15 35 37 41 56 59 69 81 84 86

```

The output will be different each time because the initial values are generated randomly.

A new constructor for `SortedList` takes an array of `Link` objects as an argument and inserts the entire contents of this array into the newly created list. This helps make things easier for the client (the `main()` routine).

We've also made a change to the `insert()` routine in this program. It now accepts a `Link` object as an argument, rather than a `double`. We do this so we can store `Link` objects in the array and insert them directly into the list. In the `sortedList.java` program, it was more convenient to have the `insert()` routine create each `Link` object, using the `double` value passed as an argument.

The downside of the list insertion sort, compared with an array-based insertion sort, is that it takes somewhat more than twice as much memory: the array and linked list must be in memory at the same time. However, if you have a sorted linked list class handy, the list insertion sort is a convenient way to sort arrays that aren't too large.

Doubly Linked Lists

Let's examine another variation on the linked list: the *doubly linked* list (not to be confused with the double-ended list). What's the advantage of a doubly linked list? A potential problem with ordinary linked lists is that it's difficult to traverse backward along the list. A statement like

```
current=current.next
```

steps conveniently to the next link, but there's no corresponding way to go to the previous link. Depending on the application, this could pose problems.

For example, imagine a text editor in which a linked list is used to store the text. Each text line on the screen is stored as a `String` object embedded in a link. When the editor's user moves the cursor downward on the screen, the program steps to the next link to manipulate or display the new line. But what happens if the user moves the cursor upward? In an ordinary linked list, you'd need to return `current` (or its equivalent) to the start of the list and then step all the way down again to the new current link. This isn't very efficient. You want to make a single step upward.

The doubly linked list provides this capability. It allows you to traverse backward as well as forward through the list. The secret is that each link has two references to other links instead of one. The first is to the next link, as in ordinary lists. The second is to the previous link. This is shown in Figure 5.13.

The beginning of the specification for the `Link` class in a doubly linked list looks like this:

```
class Link
{
    public double dData;           // data item
    public Link next;              // next link in list
    public Link previous;         // previous link in list
    ...
}
```

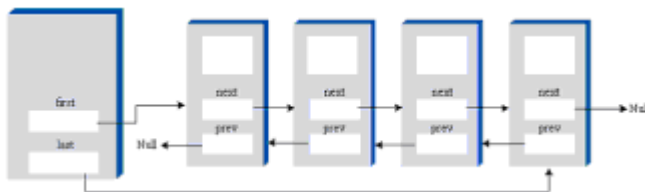

Figure 5.13: A doubly linked list

The downside of doubly linked lists is that every time you insert or delete a link you must deal with four links instead of two: two attachments to the previous link and two attachments to the following one. Also, of course, each link is a little bigger because of the extra reference.

A doubly linked list doesn't necessarily need to be a double-ended list (keeping a

reference to the last element on the list) but doing so is useful, so we'll include it in our example.

We'll show the complete listing for the `doublyLinked.java` program soon, but first let's examine some of the methods in its `doublyLinkedList` class.

Traversal

Two display methods demonstrate traversal of a doubly linked list. The `displayForward()` method is the same as the `displayList()` method we've seen in ordinary linked lists. The `displayBackward()` method is similar, but starts at the last element in the list and proceeds toward the start of the list, going to each element's `previous` field. This code fragment shows how this works:

```
Link current = last;           // start at end
while(current != null)        // until start of list,
    current = current.previous; // move to previous link
```

Incidentally, some people take the view that, because you can go either way equally easily on a doubly linked list, there is no preferred direction and therefore terms like `previous` and `next` are inappropriate. If you prefer, you can substitute direction-neutral terms such as `left` and `right`.

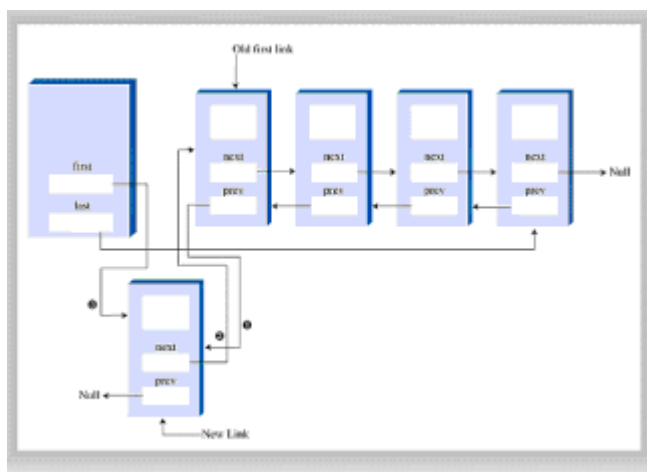

Figure 5.14: Insertion at the beginning

Insertion

We've included several insertion routines in the `DoublyLinkedList` class. The `insertFirst()` method inserts at the beginning of the list, `insertLast()` inserts at the end, and `insertAfter()` inserts following an element with a specified key.

Unless the list is empty, the `insertFirst()` routine changes the `previous` field in the old `first` link to point to the new link, and changes the `next` field in the new link to point to the old first link. Finally it sets `first` to point to the new link. This is shown in Figure 5.14.

If the list is empty, then the `last` field must be changed instead of the `first.previous` field. Here's the code:

```
if( isEmpty() )                // if empty list,
```

```

    last = newLink;           // newLink <-- last
else
    first.previous = newLink; // newLink <-- old first
newLink.next = first;       // newLink --> old first
first = newLink;           // first --> newLink

```

The `insertLast()` method is the same process applied to the end of the list; it's a mirror image of `insertFirst()`.

The `insertAfter()` method inserts a new link following the link with a specified key value. It's a bit more complicated because four connections must be made. First the link with the specified key value must be found. This is handled the same way as the `find()` routine in the `linkList2` program earlier in this chapter. Then, assuming we're not at the end of the list, two connections must be made between the new link and the next link, and two more between `current` and the new link. This is shown in Figure 5.15.

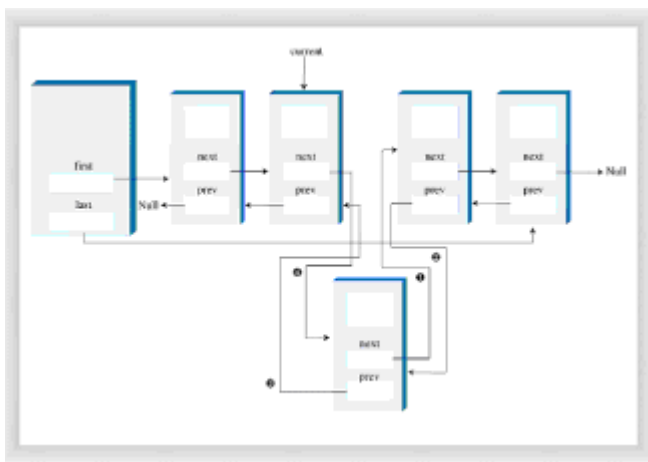

Figure 5.15: Insertion at an arbitrary location

If the new link will be inserted at the end of the list, then its `next` field must point to `null`, and `last` must point to the new link. Here's the `insertAfter()` code that deals with the links:

```

if(current==last)           // if last link,
{
    newLink.next = null;    // newLink --> null
    last = newLink;        // newLink <-- last
}
else                         // not last link,
{
    newLink.next = current.next; // newLink --> old next
                                // newLink <-- old next
    current.next.previous = newLink;
}
newLink.previous = current; // old current <-- newLink

current.next = newLink;     // old current --> newLink

```

Perhaps you're unfamiliar with the use of two dot operators in the same expression. It's a natural extension of a single dot operator. The expression

```
current.next.previous
```

means the `previous` field of the link referred to by the `next` field in the link `current`.

Deletion

There are three deletion routines: `deleteFirst()`, `deleteLast()`, and `deleteKey()`. The first two are fairly straightforward. In `deleteKey()`, the key being deleted is `current`. Assuming the link to be deleted is neither the first nor the last one in the list, then the `next` field of `current.previous` (the link before the one being deleted) is set to point to `current.next` (the link following the one being deleted), and the `previous` field of `current.next` is set to point to `current.previous`. This disconnects the current link from the list. Figure 5.16 shows how this disconnection looks, and the following two statements carry it out:

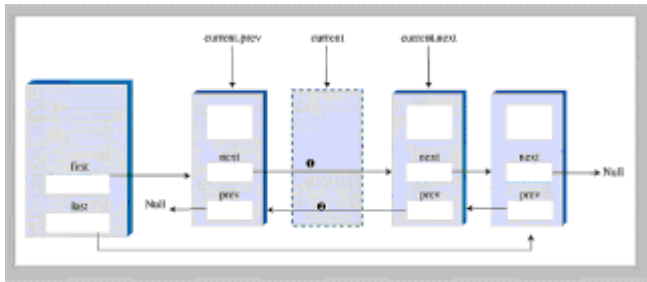

Figure 5.16: Deleting an arbitrary link

```
current.previous.next = current.next;  
current.next.previous = current.previous;
```

Special cases arise if the link to be deleted is either the first or last in the list, because `first` or `last` must be set to point to the next or the previous link. Here's the code from `deleteKey()` for dealing with link connections:

```
if(current==first)           // first item?  
    first = current.next;    // first --> old next  
else                          // not first  
    // old previous --> old next  
    current.previous.next = current.next;  
  
if(current==last)           // last item?  
    last = current.previous; // old previous <-- last  
else                          // not last  
    // old previous <-- old next  
    current.next.previous = current.previous;
```

The `doublyLinked.java` Program

Listing 5.8 shows the complete `doublyLinked.java` program, which includes all the routines just discussed.

Listing 5.8 The `doublyLinked.java` Program

```

// doublyLinked.java
// demonstrates a doubly-linked list
// to run this program: C>java DoublyLinkedApp
////////////////////////////////////
class Link
{
    public double dData;           // data item
    public Link next;             // next link in list
    public Link previous;        // previous link in list

// -----
-
    public Link(double d)         // constructor
        { dData = d; }

// -----
-
    public void displayLink()    // display this link
        { System.out.print(dData + " "); }

// -----
-
} // end class Link

////////////////////////////////////

class DoublyLinkedList
{
    private Link first;          // ref to first item
    private Link last;          // ref to last item

// -----
-
    public DoublyLinkedList()    // constructor
        {
            first = null;        // no items on list yet
            last = null;
        }

// -----
-
    public boolean isEmpty()     // true if no links
        { return first==null; }

// -----
-
    public void insertFirst(double dd) // insert at front of
list
    {
        Link newLink = new Link(dd); // make new link
        if( isEmpty() )              // if empty list,
            last = newLink;          // newLink <-- last
        else
            first.previous = newLink; // newLink <-- old first
            newLink.next = first;    // newLink --> old first
    }
}

```

```

        first = newLink;                // first --> newLink
    }

// -----
-
public void insertLast(double dd) // insert at end of list
{
    Link newLink = new Link(dd); // make new link
    if( isEmpty() ) // if empty list,
        first = newLink; // first --> newLink
    else
    {
        last.next = newLink; // old last --> newLink
        newLink.previous = last; // old last <-- newLink
    }
    last = newLink; // newLink <-- last
}

// -----
-
public Link deleteFirst() // delete first link
{ // (assumes non-empty
list)
    Link temp = first;
    if(first.next == null) // if only one item
        last = null; // null <-- last
    else
        first.next.previous = null; // null <-- old next
    first = first.next; // first --> old next
    return temp;
}

// -----
-
public Link deleteLast() // delete last link
{ // (assumes non-empty
list)
    Link temp = last;
    if(first.next == null) // if only one item
        first = null; // first --> null
    else
        last.previous.next = null; // old previous --> null
    last = last.previous; // old previous <-- last
    return temp;
}

// -----
-
// insert dd just after
key
public boolean insertAfter(double key, double dd)
{ // (assumes non-empty
list)
    Link current = first; // start at beginning
    while(current.dData != key) // until match is found,

```

```

    {
        current = current.next;    // move to next link
        if(current == null)
            return false;        // didn't find it
    }
    Link newLink = new Link(dd);  // make new link

    if(current==last)            // if last link,
    {
        newLink.next = null;     // newLink --> null
        last = newLink;         // newLink <-- last
    }
    else                          // not last link,
    {
        newLink.next = current.next; // newLink --> old next
                                    // newLink <-- old next
        current.next.previous = newLink;
    }
    newLink.previous = current;   // old current <-- newLink
    current.next = newLink;       // old current --> newLink
    return true;                  // found it, did insertion
}

// -----
-
    public Link deleteKey(double key) // delete item w/ given
key
    {
        // (assumes non-empty
list)
        Link current = first;      // start at beginning
        while(current.dData != key) // until match is found,
        {
            current = current.next; // move to next link
            if(current == null)
                return null;        // didn't find it
        }
        if(current==first)         // found it; first item?
            first = current.next;  // first --> old next
        else                       // not first
            // old previous --> old
next
            current.previous.next = current.next;

        if(current==last)         // last item?
            last = current.previous; // old previous <-- last
        else                       // not last
            // old previous <-- old
next
            current.next.previous = current.previous;
        return current;           // return value
    }

// -----
-

```



```

public void displayForward()
{
    System.out.print("List (first-->last): ");
    Link current = first;          // start at beginning
    while(current != null)         // until end of list,
    {
        current.displayLink();     // display data
        current = current.next;    // move to next link
    }
    System.out.println("");
}

// -----
-
public void displayBackward()
{
    System.out.print("List (last-->first): ");
    Link current = last;          // start at end
    while(current != null)        // until start of list,
    {
        current.displayLink();     // display data
        current = current.previous; // move to previous link
    }
    System.out.println("");
}

// -----
-
} // end class DoublyLinkedList

////////////////////////////////////

class DoublyLinkedApp
{
    public static void main(String[] args)
    {
        // make a new list
        DoublyLinkedList theList = new DoublyLinkedList();

        theList.insertFirst(22);    // insert at front
        theList.insertFirst(44);
        theList.insertFirst(66);

        theList.insertLast(11);     // insert at rear
        theList.insertLast(33);
        theList.insertLast(55);

        theList.displayForward();   // display list forward
        theList.displayBackward();  // display list backward

        theList.deleteFirst();      // delete first item
        theList.deleteLast();       // delete last item
        theList.deleteKey(11);      // delete item with key 11
    }
}

```

```

        theList.displayForward();        // display list forward

        theList.insertAfter(22, 77);    // insert 77 after 22
        theList.insertAfter(33, 88);    // insert 88 after 33

        theList.displayForward();        // display list forward
    } // end main()

} // end class DoublyLinkedListApp

```

In `main()` we insert some items at the beginning of the list and at the end, display the items going both forward and backward, delete the first and last items and the item with key 11, display the list again (forward only), insert two items using the `insertAfter()` method, and display the list again. Here's the output:

```

List (first-->last): 66 44 22 11 33 55
List (last-->first): 55 33 11 22 44 66
List (first-->last): 44 22 33
List (first-->last): 44 22 77 33 88

```

The deletion methods and the `insertAfter()` method assume that the list isn't empty. Although for simplicity we don't show it in `main()`, `isEmpty()` should be used to verify that there's something in the list before attempting such insertions and deletions.

Doubly Linked List as Basis for Deques

A doubly linked list can be used as the basis for a deque, mentioned in the [last chapter](#). In a deque you can insert and delete at either end, and the doubly linked list provides this capability.

Iterators

We've seen how it's possible for the user of a list to find a link with a given key using a `find()` method. The method starts at the beginning of the list and examines each link until it finds one matching the search key. Other operations we've looked at, such as deleting a specified link or inserting before or after a specified link, also involve searching through the list to find the specified link. However, these methods don't give the user any control over the traversal to the specified item.

Suppose you wanted to traverse a list, performing some operation on certain links. For example, imagine a personnel file stored as a linked list. You might want to increase the wages of all employees who were being paid minimum wage, without affecting employees already above the minimum. Or suppose that in a list of mail-order customers, you decided to delete all customers who had not ordered anything in six months.

In an array, such operations are easy because you can use an array index to keep track of your position. You can operate on one item, then increment the index to point to the next item, and see if that item is a suitable candidate for the operation. However, in a linked list, the links don't have fixed index numbers. How can we provide a list's user with something analogous to an array index? You could repeatedly use `find()` to look for appropriate items in a list, but this requires many comparisons to find each link. It's far more efficient to step from link to link, checking if each one meets certain criteria and performing the appropriate operation if it does.

A Reference in the List Itself?

As users of a list class, what we need is access to a reference that can point to any arbitrary link. This allows us to examine or modify the link. We should be able to increment the reference so we can traverse along the list, looking at each link in turn, and we should be able to access the link pointed to by the reference.

Assuming we create such a reference, where will it be installed? One possibility is to use a field in the list itself, called `current` or something similar. You could access a link using `current`, and increment `current` to move to the next link.

One trouble with this approach is that you might need more than one such reference, just as you often use several array indices at the same time. How many would be appropriate? There's no way to know how many the user might need. Thus it seems easier to allow the user to create as many such references as necessary. To make this possible in an object-oriented language, it's natural to embed each reference in a class object. (This can't be the same as the list class, because there's only one list object.)

An Iterator Class

Objects containing references to items in data structures, used to traverse data structures, are commonly called *iterators* (or sometimes, as in certain Java classes, *enumerators*). Here's a preliminary idea of how they look:

```
class ListIterator()
{
    private Link current;
}
}
```

The `current` field contains a reference to the link the iterator currently points to. (The term "points" as used here doesn't refer to pointers in C++; we're using it in its generic sense.)

To use such an iterator, the user might create a list and then create an iterator object associated with the list. Actually, as it turns out, it's easier to let the list create the iterator, so it can pass the iterator certain information, such as a reference to its `first` field. Thus we add a `getIterator()` method to the list class; this method returns a suitable iterator object to the user. Here's some abbreviated code in `main()` that shows how the class user would invoke an iterator:

```
public static void main(...)
{
    LinkedList theList = new LinkedList();           // make list
    ListIterator iter1 = theList.getIterator();     // make iter

    Link aLink = iter1.getCurrent();              // access link at
    iter1.nextLink();                             // move iter to next link
}
}
```

Once we've made the iterator object, we can use it to access the link it points to, or increment it so it points to the next link, as shown in the second two statements. We call the iterator object `iter1` to emphasize that you could make more iterators (`iter2` and so on) the same way.

The iterator always points to some link in the list. It's associated with the list, but it's not the same as the list. Figure 5.17 shows two iterators pointing to links in a list.

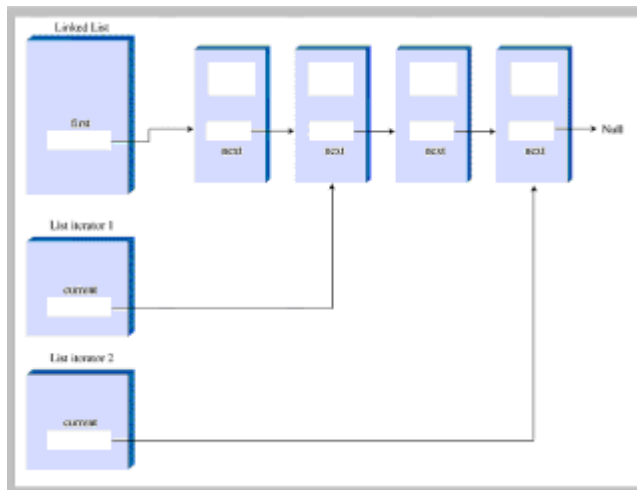

Figure 5.17: List iterators

Additional Iterator Features

We've seen several programs where the use of a `previous` field made it simpler to perform certain operations, such as deleting a link from an arbitrary location. Such a field is also useful in an iterator.

Also, it may be that the iterator will need to change the value of the list's `first` field; for example, if an item is inserted or deleted at the beginning of the list. If the iterator is an object of a separate class, how can it access a private field, such as `first`, in the list? One solution is for the list to pass a reference to itself to the iterator when it creates it. This reference is stored in a field in the iterator.

The list must then provide public methods that allow the iterator to change `first`. These are `LinkedList` methods `getFirst()` and `setFirst()`. (The weakness of this approach is that these methods allow anyone to change `first`, which introduces an element of risk.)

Here's a revised (although still incomplete) iterator class that incorporates these additional fields, along with `reset()` and `nextLink()` methods:

```
class ListIterator()
{
    private Link current;           // reference to current link
    private Link previous;         // reference to previous link
    private LinkedList ourList;    // reference to "parent" list

    public void reset()            // set to start of list
    {
        current = ourList.getFirst(); // current --> first
        previous = null;            // previous --> null
    }

    public void nextLink()         // go to next link
    {
        previous = current;        // set previous to this
        current = current.next;    // set this to next
    }
}
```

```
...  
}
```

We might note, for you old-time C++ programmers, that in C++ the connection between the iterator and the list is typically provided by making the iterator class a *friend* of the list class. However, Java has no friend classes, which are controversial in any case because they are a chink in the armor of data hiding.

Iterator Methods

Additional methods can make the iterator a flexible and powerful class. All operations previously performed by the class that involve iterating through the list, like `insertAfter()`, are more naturally performed by the iterator. In our example the iterator includes the following methods:

- `reset()` Sets iterator to the start of the list
- `nextLink()` Moves iterator to next link
- `getCurrent()` Returns the link at iterator
- `tEnd()` Returns true if iterator is at end of list
- `insertAfter()` Inserts a new link after iterator
- `insertBefore()` Inserts a new link before iterator
- `deleteCurrent()` Deletes the link at the iterator

The user can position the iterator using `reset()` and `nextLink()`, check if it's at the end of the list with `atEnd()`, and perform the other operations shown.

Deciding which tasks should be carried out by an iterator and which by the list itself is not always easy. An `insertBefore()` method works best in the iterator, but an `insertFirst()` routine that always inserts at the beginning of the list might be more appropriate in the list class. We've kept a `displayList()` routine in the list, but this operation could also be handled with `getCurrent()` and `nextLink()` calls to the iterator.

The `interIterator.java` Program

The `interIterator.java` program includes an interactive interface that permits the user to control the iterator directly. Once you've started the program, you can perform the following actions by typing the appropriate letter:

- s Show the list contents
- r Reset the iterator to the start of the list
- n Go to the next link
- g Get the contents of the current link
- b Insert before the current link

- a Insert a new link after the current link
- d Delete the current link

Listing 5.9 shows the complete `interIterator.java` program.

Listing 5.9 The `interIterator.java` Program

```
// interIterator.java
// demonstrates iterators on a linked list
// to run this program: C>java InterIterApp
import java.io.*; // for I/O
/////////////////////////////////////////////////////////////////
class Link
{
    public double dData; // data item
    public Link next; // next link in list

// -----
-
    public Link(double dd) // constructor
        { dData = dd; }

// -----
-
    public void displayLink() // display ourself
        { System.out.print(dData + " "); }
} // end class Link

/////////////////////////////////////////////////////////////////

class LinkList
{
    private Link first; // ref to first item on list

// -----
-
    public LinkList() // constructor
        { first = null; } // no items on list yet

// -----
-
    public Link getFirst() // get value of first
        { return first; }

// -----
-
    public void setFirst(Link f) // set first to new link
        { first = f; }

// -----
-
```

```

    public boolean isEmpty()          // true if list is empty
        { return first==null; }

// -----
-
    public ListIterator getIterator() // return iterator
    {
return new ListIterator(this); // initialized with
        }                               // this list

// -----
-
    public void displayList()
    {
    Link current = first;          // start at beginning of list
    while(current != null)        // until end of list,
        {
            current.displayLink(); // print data
            current = current.next; // move to next link
        }
    System.out.println("");
    }

// -----
-
    } // end class LinkList

////////////////////////////////////

class ListIterator
    {
    private Link current;          // current link
    private Link previous;        // previous link
    private LinkList ourList;     // our linked list

//-----
-
    public ListIterator(LinkList list) // constructor
    {
        ourList = list;
        reset();
    }

//-----
-
    public void reset()            // start at 'first'
    {
        current = ourList.getFirst();
        previous = null;
    }

//-----
-
    public boolean atEnd()         // true if last link

```

```

        { return (current.next==null); }

//-----
-
    public void nextLink()          // go to next link
    {
        previous = current;
        current = current.next;
    }

//-----
-
    public Link getCurrent()        // get current link
    { return current; }

//-----
-
    public void insertAfter(double dd) // insert after
    {                                  // current link
        Link newLink = new Link(dd);

        if( ourList.isEmpty() )      // empty list
        {
            ourList.setFirst(newLink);
            current = newLink;
        }
        else                          // not empty
        {
            newLink.next = current.next;
            current.next = newLink;
            nextLink();                // point to new link
        }
    }

//-----
-
    public void insertBefore(double dd) // insert before
    {                                  // current link
        Link newLink = new Link(dd);

        if(previous == null)          // beginning of list
        {                              // (or empty list)
            newLink.next = ourList.getFirst();
            ourList.setFirst(newLink);
            reset();
        }
        else                          // not beginning
        {
            newLink.next = previous.next;
            previous.next = newLink;
            current = newLink;
        }
    }
}

```



```

//-----
-
public double deleteCurrent() // delete item at current
{
double value = current.dData;
if(previous == null) // beginning of list
{
ourList.setFirst(current.next);
reset();
}
else // not beginning
{
previous.next = current.next;
if( atEnd() )
reset();
else
current = current.next;
}
return value;
}

//-----
-
} // end class ListIterator

////////////////////////////////////

class InterIterApp
{
public static void main(String[] args) throws IOException
{
LinkedList theList = new LinkedList(); // new list
ListIterator iter1 = theList.getIterator(); // new iter

double value;

iter1.insertAfter(20); // insert items
iter1.insertAfter(40);
iter1.insertAfter(80);
iter1.insertBefore(60);

while(true)
{
System.out.print("Enter first letter of show, reset,
");
System.out.print("next, get, before, after, delete:
");
System.out.flush();
int choice = getChar(); // get user's option
switch(choice)
{
case 's': // show list
if( !theList.isEmpty() )
theList.displayList();
}
}
}
}

```

```

        else
            System.out.println("List is empty");
        break;
    case 'r':                // reset (to first)
        iter1.reset();
        break;
    case 'n':                // advance to next
item
        if( !theList.isEmpty() && !iter1.atEnd() )
            iter1.nextLink();
        else
            System.out.println("Can't go to next link");
        break;
    case 'g':                // get current item
        if( !theList.isEmpty() )
        {
            value = iter1.getCurrent().dData;
            System.out.println("Returned " + value);
        }
        else
            System.out.println("List is empty");
        break;
    case 'b':                // insert before
current
        System.out.print("Enter value to insert: ");
        System.out.flush();
        value = getInt();
        iter1.insertBefore(value);
        break;
    case 'a':                // insert after
current
        System.out.print("Enter value to insert: ");
        System.out.flush();
        value = getInt();
        iter1.insertAfter(value);
        break;
    case 'd':                // delete current item
        if( !theList.isEmpty() )
        {
            value = iter1.deleteCurrent();
            System.out.println("Deleted " + value);
        }
        else
            System.out.println("Can't delete");
        break;
    default:
        System.out.println("Invalid entry");
    } // end switch
} // end while
} // end main()

//-----
-
    public static String getString() throws IOException

```

```

        {
            InputStreamReader isr = new InputStreamReader(System.in);
            BufferedReader br = new BufferedReader(isr);
            String s = br.readLine();
            return s;
        }

//-----
-
    public static int getChar() throws IOException
    {
        String s = getString();
        return s.charAt(0);
    }

//-----
-
    public static int getInt() throws IOException
    {
        String s = getString();
        return Integer.parseInt(s);
    } // end getInt()

//-----
-

} // end class InterIterApp

```

The `main()` routine inserts four items into the list, using an iterator and its `insertAfter()` method. Then it waits for the user to interact with it. In the following sample interaction, the user displays the list, resets the iterator to the beginning, goes forward two links, gets the current link's key value (which is 60), inserts 100 before this, inserts 7 after the 100, and displays the list again.

```

Enter first letter of
  show, reset, next, get, before, after, delete: s
20 40 60 80
Enter first letter of
  show, reset, next, get, before, after, delete: r
Enter first letter of
  show, reset, next, get, before, after, delete: n
Enter first letter of
  show, reset, next, get, before, after, delete: n
Enter first letter of
  show, reset, next, get, before, after, delete: g
Returned 60
Enter first letter of
  show, reset, next, get, before, after, delete: b
Enter value to insert: 100
Enter first letter of
  show, reset, next, get, before, after, delete: a
Enter value to insert: 7
Enter first letter of
  show, reset, next, get, before, after, delete: s

```

Experimenting with the `interIterator.java` program will give you a feeling for how the iterator moves along the links and how it can insert and delete links anywhere in the list.

Where Does It Point?

One of the design issues in an iterator class is deciding where the iterator should point following various operations.

When you delete an item with `deleteCurrent()`, should the iterator end up pointing to the next item, to the previous item, or back at the beginning of the list? It's convenient to keep it in the vicinity of the deleted item, because the chances are the class user will be carrying out other operations there. However, you can't move it to the previous item because there's no way to reset the list's `previous` field to the previous item. (You'd need a doubly linked list for that.) Our solution is to move the iterator to the link following the deleted link. If we've just deleted the item at the end of the list, the iterator is set to the beginning of the list.

Following calls to `insertBefore()` and `insertAfter()`, we return with `current` pointing to the newly inserted item.

The `atEnd()` Method

There's another question about the `atEnd()` method. It could return `true` when the iterator points to the last valid link in the list, or it could return `true` when the iterator points *past* the last link (and is thus not pointing to a valid link).

With the first approach, a loop condition used to iterate through the list becomes awkward because you need to perform an operation on the last link before checking whether it is the last link (and terminating the loop if it is).

However, the second approach doesn't allow you to find out you're at the end of the list until it's too late to do anything with the last link. (You couldn't look for the last link and then delete it, for example.) This is because when `atEnd()` became true, the iterator would no longer point to the last link (or indeed any valid link), and you can't "back up" the iterator in a singly linked list.

We take the first approach. This way the iterator always points to a valid link, although you must be careful when writing a loop that iterates through the list, as we'll see next.

Iterative Operations

As we noted, an iterator allows you to traverse the list, performing operations on certain data items. Here's a code fragment that displays the list contents, using an iterator instead of the list's `displayList()` method:

```
iter1.reset(); // start at first
double value = iter1.getCurrent().dData; // display link
System.out.println(value + " ");
while( !iter1.atEnd() ) // until end,
{
    iter1.nextLink(); // go to next
link,
    double value = iter1.getCurrent().dData; // display it
    System.out.println(value + " ");
```

```
}
```

Although not shown here, you should check with `isEmpty()` to be sure the list is not empty before calling `getCurrent()`.

The following code shows how you could delete all items with keys that are multiples of 3. We show only the revised `main()` routine; everything else is the same as in `interIterator.java`.

```
class InterIterApp
{
    public static void main(String[] args) throws IOException
    {
        LinkedList theList = new LinkedList();           // new list
        ListIterator iter1 = theList.getIterator();      // new iter

        iter1.insertAfter(21);                          // insert links
        iter1.insertAfter(40);
        iter1.insertAfter(30);
        iter1.insertAfter(7);
        iter1.insertAfter(45);

        theList.displayList();                          // display list

        iter1.reset();                                  // start at first link
        Link aLink = iter1.getCurrent();                // get it
        if(aLink.dData % 3 == 0)                       // if divisible by 3,
            iter1.deleteCurrent();                    // delete it
        while( !iter1.atEnd() )                       // until end of list,
        {
            iter1.nextLink();                          // go to next link

            aLink = iter1.getCurrent();                // get link
            if(aLink.dData % 3 == 0)                  // if divisible by 3,
                iter1.deleteCurrent();                // delete it
        }
        theList.displayList();                        // display list
    } // end main()

} // end class InterIterApp
```

We insert five links and display the list. Then we iterate through the list, deleting those links with keys divisible by 3, and display the list again. Here's the output:

```
21 40 30 7 45
40 7
```

Again, although this code doesn't show it, it's important to check whether the list is empty before calling `deleteCurrent()`.

Other Methods

One could create other useful methods for the `ListIterator` class. For example, a `find()` method would return an item with a specified key value, as we've seen when `find()` is a list method. A `replace()` method could replace items that had certain key values with other items.

Because it's a singly linked list, you can only iterate along it in the forward direction. If a doubly linked list were used, you could go either way, allowing operations such as deletion from the end of the list, just as with `noniterator`. This would probably be a convenience in some applications.

Summary

- A linked list consists of one `LinkedList` object and a number of `Link` objects.
- The `LinkedList` object contains a reference, often called `first`, to the first link in the list.
- Each `Link` object contains data and a reference, often called `next`, to the next link in the list.
- A `next` value of `null` signals the end of the list.
- Inserting an item at the beginning of a linked list involves changing the new link's `next` field to point to the old first link, and changing `first` to point to the new item.
- Deleting an item at the beginning of a list involves setting `first` to point to `first.next`.
- To traverse a linked list, you start at `first`; then go from link to link, using each link's `next` field to find the next link.
- A link with a specified key value can be found by traversing the list. Once found, an item can be displayed, deleted, or operated on in other ways.
- A new link can be inserted before or after a link with a specified key value, following a traversal to find this link.
- A double-ended list maintains a pointer to the last link in the list, often called `last`, as well as to the first.
- A double-ended list allows insertion at the end of the list.
- An Abstract Data Type (ADT) is a data-storage class considered without reference to its implementation.
- Stacks and queues are ADTs. They can be implemented using either arrays or linked lists.
- In a sorted linked list, the links are arranged in order of ascending (or sometimes descending) key value.
- Insertion in a sorted list takes $O(N)$ time because the correct insertion point must be found. Deletion of the smallest link takes $O(1)$ time.
- In a doubly linked list, each link contains a reference to the previous link as well as the next link.

- A doubly linked list permits backward traversal and deletion from the end of the list.
- An iterator is a reference, encapsulated in a class object, that points to a link in an associated list.
- Iterator methods allow the user to move the iterator along the list and access the link currently pointed to.
- An iterator can be used to traverse through a list, performing some operation on selected links (or all links).

Summary

- A linked list consists of one `LinkedList` object and a number of `Link` objects.
- The `LinkedList` object contains a reference, often called `first`, to the first link in the list.
- Each `Link` object contains data and a reference, often called `next`, to the next link in the list.
- A `next` value of `null` signals the end of the list.
- Inserting an item at the beginning of a linked list involves changing the new link's `next` field to point to the old first link, and changing `first` to point to the new item.
- Deleting an item at the beginning of a list involves setting `first` to point to `first.next`.
- To traverse a linked list, you start at `first`; then go from link to link, using each link's `next` field to find the next link.
- A link with a specified key value can be found by traversing the list. Once found, an item can be displayed, deleted, or operated on in other ways.
- A new link can be inserted before or after a link with a specified key value, following a traversal to find this link.
- A double-ended list maintains a pointer to the last link in the list, often called `last`, as well as to the first.
- A double-ended list allows insertion at the end of the list.
- An Abstract Data Type (ADT) is a data-storage class considered without reference to its implementation.
- Stacks and queues are ADTs. They can be implemented using either arrays or linked lists.
- In a sorted linked list, the links are arranged in order of ascending (or sometimes descending) key value.
- Insertion in a sorted list takes $O(N)$ time because the correct insertion point must be found. Deletion of the smallest link takes $O(1)$ time.
- In a doubly linked list, each link contains a reference to the previous link as well as the next link.

- A doubly linked list permits backward traversal and deletion from the end of the list.
- An iterator is a reference, encapsulated in a class object, that points to a link in an associated list.
- Iterator methods allow the user to move the iterator along the list and access the link currently pointed to.
- An iterator can be used to traverse through a list, performing some operation on selected links (or all links).

Triangular Numbers

It's said that the Pythagorians, a band of mathematicians in ancient Greece who worked under Pythagoras (of Pythagorean theorem fame), felt a mystical connection with the series of numbers 1, 3, 6, 10, 15, 21, ... (where the ... means the series continues indefinitely). Can you find the next member of this series?

The n th term in the series is obtained by adding n to the previous term. Thus the second term is found by adding 2 to the first term (which is 1), giving 3. The third term is 3 added to the second term (which is 3), giving 6, and so on. The numbers in this series are called *triangular numbers* because they can be visualized as a triangular arrangements of objects, shown as little squares in Figure 6.1.

Finding the n th Term Using a Loop

Suppose you wanted to find the value of some arbitrary n th term in the series; say the fourth term (whose value is 10). How would you calculate it? Looking at Figure 6.2, you might decide that the value of any term can be obtained by adding up all the vertical columns of squares.

In the fourth term, the first column has four little squares, the second column has three, and so on. Adding $4+3+2+1$ gives 10.

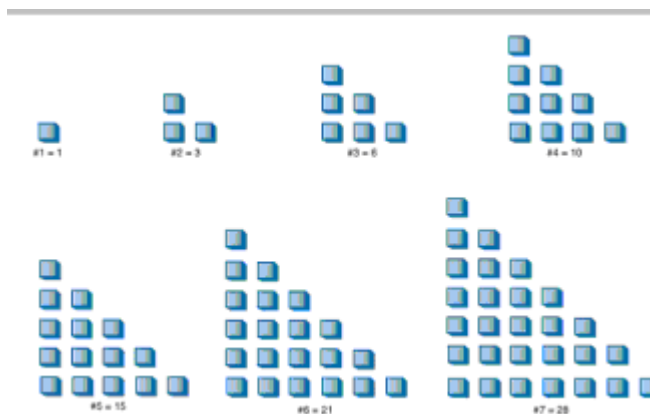

Figure 6.1: The triangular numbers

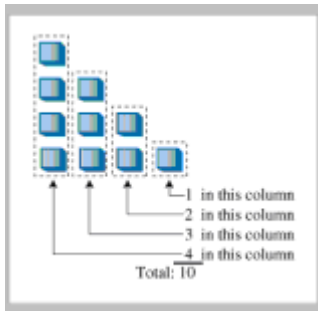

Figure 6.2: Triangular number as columns

The following `triangle()` method uses this column-based technique to find a triangular number. It sums all the columns, from a height of `n` to a height of 1.

```
int triangle(int n)
{
    int total = 0;

    while(n > 0)           // until n is 1
    {
        total = total + n; // add n (column height) to total
        --n;              // decrement column height
    }
    return total;
}
```

The method cycles around the loop `n` times, adding `n` to `total` the first time, `n-1` the second time, and so on down to 1, quitting the loop when `n` becomes 0.

Finding the *n*th Term Using Recursion

The loop approach may seem straightforward, but there's another way to look at this problem. The value of the *n*th term can be thought of as the sum of only two things, instead of a whole series. These are

1. The first (tallest) column, which has the value `n`.
2. The sum of all the remaining columns.

This is shown in Figure 6.3.

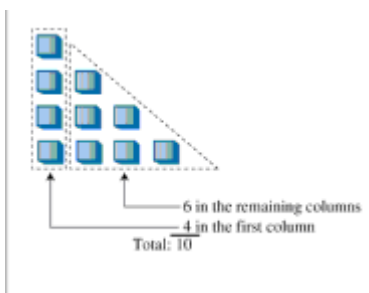

Figure 6.3: Triangular number as column plus triangle

Finding the Remaining Columns

If we knew about a method that found the sum of all the remaining columns, then we could write our `triangle()` method, which returns the value of the n th triangular number, like this:

```
int triangle(int n)
{
    return( n + sumRemainingColumns(n) ); // (incomplete
version)

}
```

But what have we gained here? It looks like it's just as hard to write the `sumRemainingColumns()` method as to write the `triangle()` method in the first place.

Notice in Figure 6.3, however, that the sum of all the remaining columns for term n is the same as the sum of *all* the columns for term $n-1$. Thus, if we knew about a method that summed all the columns for term n , we could call it with an argument of $n-1$ to find the sum of all the remaining columns for term n :

```
int triangle(int n)
{
    return( n + sumAllColumns(n-1) ); // (incomplete version)

}
```

But when you think about it, the `sumAllColumns()` method is doing exactly the same thing the `triangle()` method is doing: summing all the columns for some number n passed as an argument. So why not use the `triangle()` method itself, instead of some other method? That would look like this:

```
int triangle(int n)
{
    return( n + triangle(n-1) ); // (incomplete version)

}
```

It may seem amazing that a method can call itself, but why shouldn't it be able to? A method call is (among other things) a transfer of control to the start of the method. This transfer of control can take place from within the method as well as from outside.

Passing the Buck

All this may seem like passing the buck. Someone tells me to find the 9th triangular number. I know this is 9 plus the 8th triangular number, so I call Harry and ask him to find the 8th triangular number. When I hear back from him, I'll add 9 to whatever he tells me, and that will be the answer.

Harry knows the 8th triangular number is 8 plus the 7th triangular number, so he calls Sally and asks her to find the 7th triangular number. This process continues with each person passing the buck to another one.

Where does this buck-passing end? Someone at some point must be able to figure out an answer that doesn't involve asking another person to help them. If this didn't happen, there would be an infinite chain of people asking other people questions; a sort of arithmetic Ponzi scheme that would never end. In the case of `triangle()`, this would mean the method calling itself over and over in an infinite series that would paralyze the program.

The Buck Stops Here

To prevent an infinite regress, the person who is asked to find the first triangular number of the series, when n is 1, must know, without asking anyone else, that the answer is 1. There are no smaller numbers to ask anyone about, there's nothing left to add to anything else, so the buck stops there. We can express this by adding a condition to the `triangle()` method:

```
int triangle(int n)
{
    if(n==1)
        return 1;
    else
        return( n + triangle(n-1) );
}
```

The condition that leads to a recursive method returning without making another recursive call is referred to as the *base case*. It's critical that every recursive method have a base case to prevent infinite recursion and the consequent demise of the program.

The `triangle.java` Program

Does recursion actually work? If you run the `triangle.java` program, you'll see that it does. Enter a value for the term number, n , and the program will display the value of the corresponding triangular number. Listing 6.1 shows the `triangle.java` program.

Listing 6.1 The `triangle.java` Program

```
// triangle.java
// evaluates triangular numbers
// to run this program: C>java TriangleApp
import java.io.*; // for I/O
////////////////////////////////////
class TriangleApp
{
    static int theNumber;

    public static void main(String[] args) throws IOException
    {
        System.out.print("Enter a number: ");
        System.out.flush();
        theNumber = getInt();
        int theAnswer = triangle(theNumber);
        System.out.println("Triangle="+theAnswer);
    } // end main()

    //-----
```

```

public static int triangle(int n)
{
    if(n==1)
        return 1;
    else
        return( n + triangle(n-1) );
}

//-----
public static String getString() throws IOException
{
    InputStreamReader isr = new InputStreamReader(System.in);
    BufferedReader br = new BufferedReader(isr);
    String s = br.readLine();
    return s;
}

//-----
-
public static int getInt() throws IOException
{
    String s = getString();
    return Integer.parseInt(s);
}

//-----
-

} // end class TriangleApp

```

The `main()` routine prompts the user for a value for `n`, calls `triangle()`, and displays the return value. The `triangle()` method calls itself repeatedly to do all the work.

Here's some sample output:

```

Enter a number: 1000
Triangle = 500500

```

Incidentally, if you're skeptical of the results returned from `triangle()`, you can check them by using the following formula:

$$\text{nth triangular number} = (n^2 + n) / 2$$

What's Really Happening?

Let's modify the `triangle()` method to provide an insight into what's happening when it executes. We'll insert some output statements to keep track of the arguments and return values:

```

public static int triangle(int n)
{
    System.out.println("Entering: n=" + n);
    if(n==1)
    {

```

```

        System.out.println("Returning 1");
        return 1;
    }
else
    {
        int temp = n + triangle(n-1);
        System.out.println("Returning " + temp);
        return temp;
    }
}

```

Here's the interaction when this method is substituted for the earlier `triangle()` method and the user enters 5:

```
Enter a number: 5
```

```

Entering: n=5
Entering: n=4
Entering: n=3
Entering: n=2
Entering: n=1
Returning 1
Returning 3
Returning 6
Returning 10
Returning 15

```

```
Triangle = 15
```

Each time the `triangle()` method calls itself, its argument, which starts at 5, is reduced by 1. The method plunges down into itself again and again until its argument is reduced to 1. Then it returns. This triggers an entire series of returns. The method rises back up, phoenixlike, out of the discarded versions of itself. Each time it returns, it adds the value of `n` it was called with to the return value from the method it called.

The return values recapitulate the series of triangular numbers, until the answer is returned to `main()`. Figure 6.4 shows how each invocation of the `triangle()` method can be imagined as being "inside" the previous one.

Notice that, just before the innermost version returns a 1, there are actually five different incarnations of `triangle()` in existence at the same time. The outer one was passed the argument 5; the inner one was passed the argument 1.

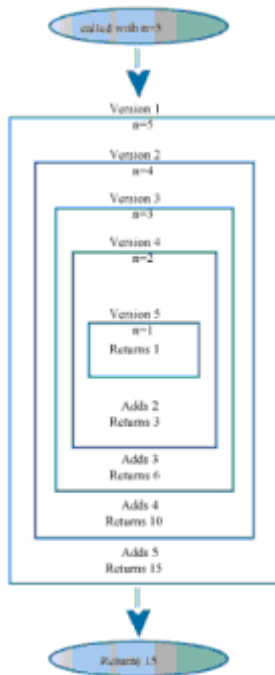

Figure 6.4: The recursive `triangle()` method

Characteristics of Recursive Methods

Although it's short, the `triangle()` method possesses the key features common to all recursive routines:

- It calls itself.
- When it calls itself, it does so to solve a smaller problem.
- There's some version of the problem that is simple enough that the routine can solve it, and return, without calling itself.

In each successive call of a recursive method to itself, the argument becomes smaller (or perhaps a range described by multiple arguments becomes smaller), reflecting the fact that the problem has become "smaller" or easier. When the argument or range reaches a certain minimum size, a condition is triggered and the method returns without calling itself.

Is Recursion Efficient?

Calling a method involves certain overhead. Control must be transferred from the location of the call to the beginning of the method. In addition, the arguments to the method, and the address to which the method should return, must be pushed onto an internal stack so that the method can access the argument values and know where to return.

In the case of the `triangle()` method, it's probable that, as a result of this overhead, the `while` loop approach executes more quickly than the recursive approach. The penalty may not be significant, but if there are a large number of method calls as a result of a recursive method, it might be desirable to eliminate the recursion. We'll talk about this more at the end of this chapter.

Another inefficiency is that memory is used to store all the intermediate arguments and

return values on the system's internal stack. This may cause problems if there is a large amount of data, leading to stack overflow.

Recursion is usually used because it simplifies a problem conceptually, not because it's inherently more efficient.

Mathematical Induction

Recursion is the programming equivalent of mathematical induction. Mathematical induction is a way of defining something in terms of itself. (The term is also used to describe a related approach to proving theorems.) Using induction, we could define the triangular numbers mathematically by saying

```
if n = 1  
  
tri(n) = n + tri(n-1)    if n > 1
```

Defining something in terms of itself may seem circular, but in fact it's perfectly valid (provided there's a base case).

Factorials

Factorials are similar in concept to triangular numbers, except that multiplication is used instead of addition. The triangular number corresponding to n is found by adding n to the triangular number of $n-1$, while the factorial of n is found by multiplying n by the factorial of $n-1$. That is, the fifth triangular number is $5+4+3+2+1$, while the factorial of 5 is $5*4*3*2*1$, which equals 120. Table 6.1 shows the factorials of the first 10 numbers.

Table 6.1: Factorials

Number	Calculation	Factorial
0	by definition	1
1	$1 * 1$	1
2	$2 * 1$	2
3	$3 * 2$	6
4	$4 * 6$	24
5	$5 * 24$	120
6	$6 * 120$	720
7	$7 * 720$	5,040
8	$8 * 5,040$	40,320

The factorial of 0 is defined to be 1. Factorial numbers grow large very rapidly, as you can see.

A recursive method similar to `triangle()` can be used to calculate factorials. It looks like this:

```
int factorial(int n)
{
    if(n==0)
        return 1;
    else
        return (n * factorial(n-1) );
}
```

There are only two differences between `factorial()` and `triangle()`. First, `factorial()` uses an `*` instead of a `+` in the expression

```
n * factorial(n-1)
```

Second, the base condition occurs when `n` is 0, not 1. Here's some sample interaction when this method is used in a program similar to `triangle.java`:

```
Enter a number: 6
```

```
Factorial =720
```

Figure 6.5 shows how the various incarnations of `factorial()` call themselves when initially entered with `n=4`.

Calculating factorials is the classic demonstration of recursion, although factorials aren't as easy to visualize as triangular numbers.

Various other numerical entities lend themselves to calculation using recursion in a similar way, such as finding the greatest common denominator of two numbers (which is used to reduce a fraction to lowest terms), raising a number to a power, and so on. Again, while these calculations are interesting for demonstrating recursion, they probably wouldn't be used in practice because a loop-based approach is more efficient.

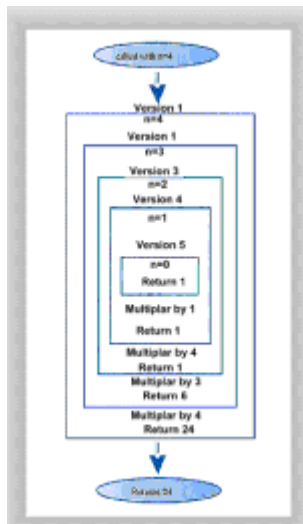

Figure 6.5: The recursive `factorial()` method

Anagrams

Here's a different kind of situation in which recursion provides a neat solution to a problem. Suppose you want to list all the anagrams of a specified word; that is, all possible letter combinations (whether they make a real English word or not) that can be made from the letters of the original word. We'll call this *anagramming* a word. Anagramming `cat`, for example, would produce

- `cat`
- `cta`
- `atc`
- `act`
- `tca`
- `tac`

Try anagramming some words yourself. You'll find that the number of possibilities is the factorial of the number of letters. For 3 letters there are 6 possible words, for 4 letters there are 24 words, for 5 letters 120 words, and so on. (This assumes that all letters are distinct; if there are multiple instances of the same letter, there will be fewer possible words.)

How would you write a program to anagram a word? Here's one approach. Assume the word has n letters.

1. Anagram the rightmost $n-1$ letters.
2. Rotate all n letters.
3. Repeat these steps n times.

To *rotate* the word means to shift all the letters one position left, except for the leftmost letter, which "rotates" back to the right, as shown in Figure 6.6.

Rotating the word n times gives each letter a chance to begin the word. While the selected letter occupies this first position, all the other letters are then anagrammed (arranged in every possible position). For cat, which has only 3 letters, rotating the remaining 2 letters simply switches them. The sequence is shown in Table 6.2.

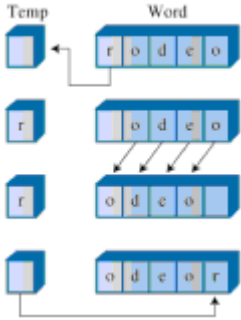

Figure 6.6: Rotating a word

Table 6.2: Anagramming the word cat

Word	Display Word?	First Letter	Remaining Letters	Action
cat	Yes	c	at	Rotate at
cta	Yes	c	Ta	Rotate ta
cat	No	c	at	Rotate cat
atc	Yes	a	Tc	Rotate tc
act	Yes	a	ct	Rotate ct
atc	No	a	Tc	Rotate atc
tca	Yes	t	ca	Rotate ca
tac	Yes	t	ac	Rotate ac
tca	No	t	ca	Rotate tca
cat	No	c	at	Done

Notice that we must rotate back to the starting point with two letters before performing a 3-letter rotation. This leads to sequences like cat, cta, cat. The redundant combinations aren't displayed.

How do we anagram the rightmost $n-1$ letters? By calling ourselves. The recursive `doAnagram()` method takes the size of the word to be anagrammed as its only parameter. This word is understood to be the rightmost n letters of the complete word. Each time `doAnagram()` calls itself, it does so with a word one letter smaller than before, as shown in [Figure 6.7](#).

The base case occurs when the size of the word to be anagrammed is only one letter. There's no way to rearrange one letter, so the method returns immediately. Otherwise, it anagrams all but the first letter of the word it was given and then rotates the entire word. These two actions are performed n times, where n is the size of the word. Here's the recursive routine `doAnagram()`:

```
public static void doAnagram(int newSize)
{
    if(newSize == 1)                // if too small,
        return;                    // go no further
    for(int j=0; j<newSize; j++)    // for each position,
    {
        doAnagram(newSize-1);      // anagram remaining
        if(newSize==2)             // if innermost,
            displayWord();         // display it
        rotate(newSize);           // rotate word
    }
}
```

Each time the `doAnagram()` method calls itself, the size of the word is one letter smaller, and the starting position is one cell further to the right, as shown in [Figure 6.8](#).

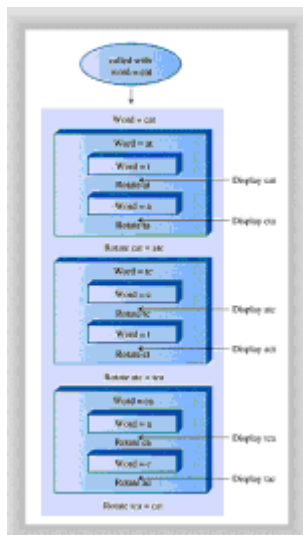

Figure 6.7: The recursive `doAnagram()` method

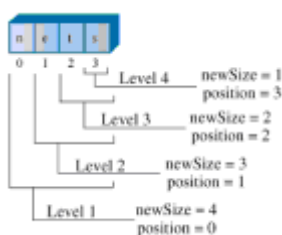

Figure 6.8: Smaller and smaller words

Listing 6.2 shows the complete `anagram.java` program. The `main()` routine gets a word from the user, inserts it into a character array so it can be dealt with conveniently, and then calls `doAnagram()`.

Listing 6.2 The `anagram.java` Program

```
// anagram.java
// creates anagrams
// to run this program: C>java AnagramApp
import java.io.*;          // for I/O
////////////////////////////////////
class AnagramApp
{
    static int size;
    static int count;
    static char[] arrChar = new char[100];

    public static void main(String[] args) throws IOException
    {
        System.out.print("Enter a word: ");    // get word
        System.out.flush();
        String input = getString();
        size = input.length();                // find its size
        count = 0;
        for(int j=0; j<size; j++)            // put it in array
            arrChar[j] = input.charAt(j);
        doAnagram(size);                    // anagram it
    } // end main()

    //-----
-
    public static void doAnagram(int newSize)
    {
        if(newSize == 1)                    // if too small,
            return;                        // go no further
        for(int j=0; j<newSize; j++)        // for each
position,
        {
            doAnagram(newSize-1);          // anagram remaining
            if(newSize==2)                 // if innermost,
                displayWord();            // display it
            rotate(newSize);              // rotate word
        }
    }

    //-----
-
    // rotate left all chars from position to end
    public static void rotate(int newSize)
    {
```

```

        int j;
        int position = size - newSize;
        char temp = arrChar[position];           // save first letter
        for(j=position+1; j<size; j++)         // shift others left
            arrChar[j-1] = arrChar[j];
        arrChar[j-1] = temp;                   // put first on
right
    }

//-----
-
public static void displayWord()
{
    if(count < 99)
        System.out.print(" ");
    if(count < 9)
        System.out.print(" ");
    System.out.print(++count + " ");
    for(int j=0; j<size; j++)
        System.out.print( arrChar[j] );
    System.out.print("  ");
    System.out.flush();
    if(count%6 == 0)
        System.out.println("");
}

//-----
-
public static String getString() throws IOException
{
    InputStreamReader isr = new InputStreamReader(System.in);
    BufferedReader br = new BufferedReader(isr);
    String s = br.readLine();
    return s;
}

//-----
---

} // end class AnagramApp

```

The `rotate()` method rotates the word one position left as described earlier. The `displayWord()` method displays the entire word and adds a count to make it easy to see how many words have been displayed. Here's some sample interaction with the program:

```

Enter a word: cats
1 cats    2 cast    3 ctsa    4 ctas    5 csat    6 csta
7 atsc    8 atcs    9 asct    10 astc   11 acts   12 acst
13 tsca   14 tsac   15 tcas   16 tcsa   17 tasc   18 tacs
19 scat   20 scta   21 satc   22 sact   23 stca   24 stac

```

(Is it only coincidence that `scat` is an anagram of `cats`?) You can use the program to anagram 5-letter or even 6-letter words. However, because the factorial of 6 is 720, this may generate more words than you want to know about.

Anagrams

Here's a different kind of situation in which recursion provides a neat solution to a problem. Suppose you want to list all the anagrams of a specified word; that is, all possible letter combinations (whether they make a real English word or not) that can be made from the letters of the original word. We'll call this *anagramming* a word.

Anagramming `cat`, for example, would produce

- `cat`
- `cta`
- `atc`
- `act`
- `tca`
- `tac`

Try anagramming some words yourself. You'll find that the number of possibilities is the factorial of the number of letters. For 3 letters there are 6 possible words, for 4 letters there are 24 words, for 5 letters 120 words, and so on. (This assumes that all letters are distinct; if there are multiple instances of the same letter, there will be fewer possible words.)

How would you write a program to anagram a word? Here's one approach. Assume the word has n letters.

1. Anagram the rightmost $n-1$ letters.
2. Rotate all n letters.
3. Repeat these steps n times.

To *rotate* the word means to shift all the letters one position left, except for the leftmost letter, which "rotates" back to the right, as shown in Figure 6.6.

Rotating the word n times gives each letter a chance to begin the word. While the selected letter occupies this first position, all the other letters are then anagrammed (arranged in every possible position). For `cat`, which has only 3 letters, rotating the remaining 2 letters simply switches them. The sequence is shown in Table 6.2.

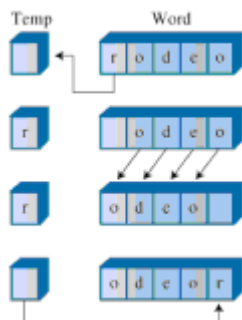

Figure 6.6: Rotating a word

Table 6.2: Anagramming the word cat

Word	Display Word?	First Letter	Remaining Letters	Action
cat	Yes	c	at	Rotate at
cta	Yes	c	Ta	Rotate ta
cat	No	c	at	Rotate cat
atc	Yes	a	Tc	Rotate tc
act	Yes	a	ct	Rotate ct
atc	No	a	Tc	Rotate atc
tca	Yes	t	ca	Rotate ca
tac	Yes	t	ac	Rotate ac
tca	No	t	ca	Rotate tca
cat	No	c	at	Done

Notice that we must rotate back to the starting point with two letters before performing a 3-letter rotation. This leads to sequences like cat, cta, cat. The redundant combinations aren't displayed.

How do we anagram the rightmost $n-1$ letters? By calling ourselves. The recursive `doAnagram()` method takes the size of the word to be anagrammed as its only parameter. This word is understood to be the rightmost n letters of the complete word. Each time `doAnagram()` calls itself, it does so with a word one letter smaller than before, as shown in [Figure 6.7](#).

The base case occurs when the size of the word to be anagrammed is only one letter. There's no way to rearrange one letter, so the method returns immediately. Otherwise, it anagrams all but the first letter of the word it was given and then rotates the entire word. These two actions are performed n times, where n is the size of the word. Here's the recursive routine `doAnagram()`:

```
public static void doAnagram(int newSize)
{
    if(newSize == 1)                // if too small,
        return;                    // go no further
    for(int j=0; j<newSize; j++)    // for each position,
    {
        doAnagram(newSize-1);      // anagram remaining
```

```

    if(newSize==2)                // if innermost,
        displayWord();           // display it
    rotate(newSize);              // rotate word
}
}

```

Each time the `doAnagram()` method calls itself, the size of the word is one letter smaller, and the starting position is one cell further to the right, as shown in Figure 6.8.

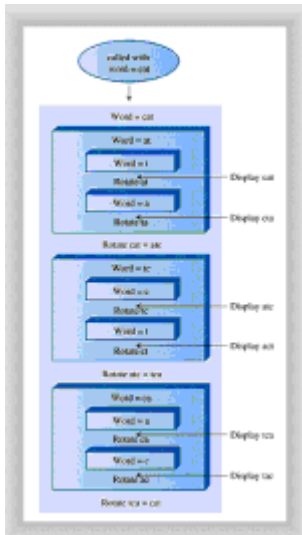

Figure 6.7: The recursive `doAnagram()` method

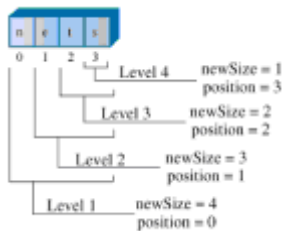

Figure 6.8: Smaller and smaller words

Listing 6.2 shows the complete `anagram.java` program. The `main()` routine gets a word from the user, inserts it into a character array so it can be dealt with conveniently, and then calls `doAnagram()`.

Listing 6.2 The `anagram.java` Program

```

// anagram.java
// creates anagrams
// to run this program: C>java AnagramApp
import java.io.*;                // for I/O
////////////////////////////////////
class AnagramApp
{
    static int size;

```



```

static int count;
static char[] arrChar = new char[100];

public static void main(String[] args) throws IOException
{
    System.out.print("Enter a word: ");    // get word
    System.out.flush();
    String input = getString();
    size = input.length();                // find its size
    count = 0;
    for(int j=0; j<size; j++)            // put it in array
        arrChar[j] = input.charAt(j);
    doAnagram(size);                    // anagram it
} // end main()

//-----
-
public static void doAnagram(int newSize)
{
    if(newSize == 1)                    // if too small,
        return;                        // go no further
    for(int j=0; j<newSize; j++)        // for each
position,
    {
        doAnagram(newSize-1);          // anagram remaining
        if(newSize==2)                 // if innermost,
            displayWord();             // display it
        rotate(newSize);               // rotate word
    }
}

//-----
-
// rotate left all chars from position to end
public static void rotate(int newSize)
{
    int j;
    int position = size - newSize;
    char temp = arrChar[position];      // save first letter
    for(j=position+1; j<size; j++)      // shift others left
        arrChar[j-1] = arrChar[j];
    arrChar[j-1] = temp;                // put first on
right
}

//-----
-
public static void displayWord()
{
    if(count < 99)
        System.out.print(" ");
    if(count < 9)
        System.out.print(" ");
    System.out.print(++count + " ");
}

```

```

        for(int j=0; j<size; j++)
            System.out.print( arrChar[j] );
        System.out.print("  ");
        System.out.flush();
        if(count%6 == 0)
            System.out.println("");
    }

    //-----
-
    public static String getString() throws IOException
    {
        InputStreamReader isr = new InputStreamReader(System.in);
        BufferedReader br = new BufferedReader(isr);
        String s = br.readLine();
        return s;
    }

    //-----
---

    } // end class AnagramApp

```

The `rotate()` method rotates the word one position left as described earlier. The `displayWord()` method displays the entire word and adds a count to make it easy to see how many words have been displayed. Here's some sample interaction with the program:

```

Enter a word: cats
1 cats      2 cast      3 ctsa      4 ctas      5 csat      6 csta
7 atsc      8 atcs      9 asct     10 astc     11 acts     12 acst
13 tsca     14 tsac     15 tcas     16 tcsa     17 tasc     18 tacs
19 scat     20 scta     21 satc     22 sact     23 stca     24 stac

```

(Is it only coincidence that `scat` is an anagram of `cats`?) You can use the program to anagram 5-letter or even 6-letter words. However, because the factorial of 6 is 720, this may generate more words than you want to know about.

The Towers of Hanoi

The Towers of Hanoi is an ancient puzzle consisting of a number of disks placed on three columns, as shown in [Figure 6.10](#).

The disks all have different diameters and holes in the middle so they will fit over the columns. All the disks start out on column A. The object of the puzzle is to transfer all the disks from column A to column C. Only one disk can be moved at a time, and no disk can be placed on a disk that's smaller than itself.

There's an ancient myth that somewhere in India, in a remote temple, monks labor day and night to transfer 64 golden disks from one of three diamond-studded towers to another. When they are finished, the world will end. Any alarm you may feel, however, will be dispelled when you see how long it takes to solve the puzzle for far fewer than 64 disks.

The Towers Workshop Applet

Start up the Towers Workshop applet. You can attempt to solve the puzzle yourself by using the mouse to drag the topmost disk to another tower. Figure 6.11 shows how this looks after several moves have been made.

There are three ways to use the workshop applet.

- You can attempt to solve the puzzle manually, by dragging the disks from tower to tower.
- You can repeatedly press the Step button to watch the algorithm solve the puzzle. At each step in the solution, a message is displayed, telling you what the algorithm is doing.
- You can press the Run button and watch the algorithm solve the puzzle with no intervention on your part; the disks zip back and forth between the posts.

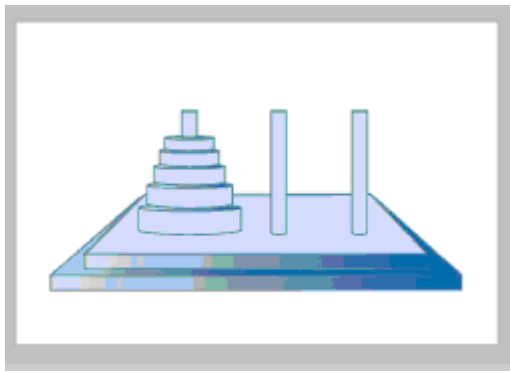

Figure 6.10: The Towers of Hanoi

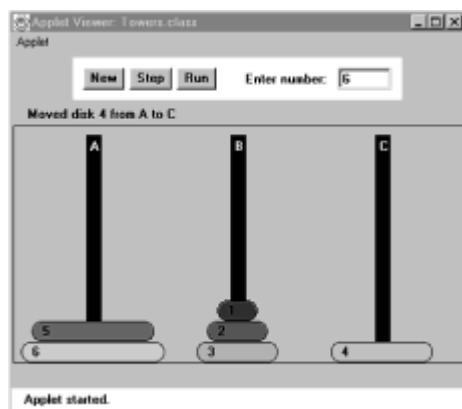

Figure 6.11: The Towers Workshop applet

To restart the puzzle, type in the number of disks you want to use, from 1 to 10, and press New twice. (After the first time, you're asked to verify that restarting is what you want to do.) The specified number of disks will be arranged on tower A. Once you drag a disk with the mouse, you can't use Step or Run; you must start over with New. However, you can switch to manual in the middle of stepping or running, and you can switch to Step when you're running, and Run when you're stepping.

Try solving the puzzle manually with a small number of disks, say 3 or 4. Work up to higher numbers. The applet gives you the opportunity to learn intuitively how the problem is solved.

Moving Subtrees

Let's call the initial tree-shaped (or pyramid-shaped) arrangement of disks on tower A a *tree*. As you experiment with the applet, you'll begin to notice that smaller tree-shaped stacks of disks are generated as part of the solution process. Let's call these smaller trees, containing fewer than the total number of disks, *subtrees*. For example, if you're trying to transfer 4 disks, you'll find that one of the intermediate steps involves a subtree of 3 disks on tower B, as shown in Figure 6.12.

These subtrees form many times in the solution of the puzzle. This is because the creation of a subtree is the only way to transfer a larger disk from one tower to another: all the smaller disks must be placed on an intermediate tower, where they naturally form a subtree.



Figure 6.12: A subtree on tower B

Here's a rule of thumb that may help when you try to solve the puzzle manually. If the subtree you're trying to move has an odd number of disks, start by moving the topmost disk directly to the tower where you want the subtree to go. If you're trying to move a subtree with an even number of disks, start by moving the topmost disk to the intermediate tower.

The Recursive Algorithm

The solution to the Towers of Hanoi puzzle can be expressed recursively using the notion of subtrees. Suppose you want to move all the disks from a source tower (call it S) to a destination tower (call it D). You have an intermediate tower available (call it I). Assume there are n disks on tower S. Here's the algorithm:

1. Move the subtree consisting of the top $n-1$ disks from S to I.
2. Move the remaining (largest) disk from S to D.
3. Move the subtree from I to D.

When you begin, the source tower is A, the intermediate tower is B, and the destination tower is C. [Figure 6.13](#) shows the three steps for this situation.

First, the subtree consisting of disks 1, 2, and 3 is moved to the intermediate tower B. Then the largest disk, 4, is moved to tower C. Then the subtree is moved from B to C.

Of course, this doesn't solve the problem of how to move the subtree consisting of disks 1, 2, and 3 to tower B, because you can't move a subtree all at once; you must move it one disk at a time. Moving the 3-disk subtree is not so easy. However, it's easier than moving 4 disks.

As it turns out, moving 3 disks from A to the destination tower B can be done with the same 3 steps as moving 4 disks. That is, move the subtree consisting of the top 2 disks from tower A to intermediate tower C; then move disk 3 from A to B. Then move the subtree back from C to B.

How do you move a subtree of two disks from A to C? Move the subtree consisting of only one disk (1) from A to B. This is the base case: when you're moving only one disk, you just move it; there's nothing else to do. Then move the larger disk (2) from A to C, and replace the subtree (disk 1) on it.

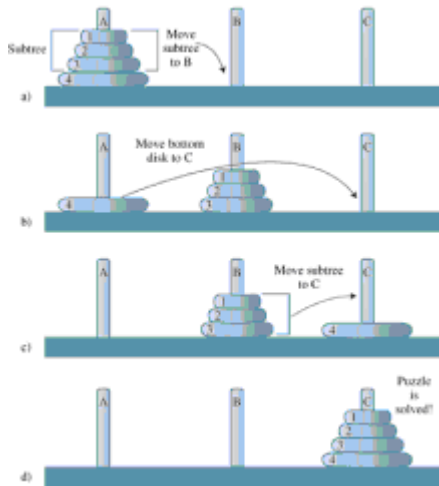

Figure 6.13: Recursive solution to Towers puzzle

The towers.java Program

The `towers.java` program solves the Towers of Hanoi puzzle using this recursive approach. It communicates the moves by displaying them; this requires much less code than displaying the towers. It's up to the human reading the list to actually carry out the moves.

The code is simplicity itself. The `main()` routine makes a single call to the recursive method `doTowers()`. This method then calls itself recursively until the puzzle is solved. In this version, shown in Listing 6.4, there are initially only 3 disks, but you can recompile the program with any number.

Listing 6.4 The towers.java Program

```
// towers.java
// evaluates triangular numbers
// to run this program: C>java TowersApp
import java.io.*; // for I/O
/////////////////////////////////////////////////////////////////
class TowersApp
{
    static int nDisks = 3;

    public static void main(String[] args)
    {
        doTowers(nDisks, 'A', 'B', 'C');
    }

    //-----
    public static void doTowers(int topN,
                                char from, char inter, char to)
```

```

    {
    if(topN==1)
        System.out.println("Disk 1 from " + from + " to "+
to);
    else
        {
        doTowers(topN-1, from, to, inter); // from-->inter

        System.out.println("Disk " + topN +
            " from " + from + " to "+ to);
        doTowers(topN-1, inter, from, to); // inter-->to
        }
    }

//-----

} // end class TowersApp

```

Remember that 3 disks are moved from A to C. Here's the output from the program:

```

Disk 1 from A to C
Disk 2 from A to B
Disk 1 from C to B
Disk 3 from A to C
Disk 1 from B to A
Disk 2 from B to C
Disk 1 from A to C

```

The arguments to `doTowers()` are the number of disks to be moved, and the source (`from`), intermediate (`inter`), and destination (`to`) towers to be used. The number of disks decreases by 1 each time the method calls itself. The source, intermediate, and destination towers also change.

Here is the output with additional notations that show when the method is entered and when it returns, its arguments, and whether a disk is moved because it's the base case (a subtree consisting of only one disk) or because it's the remaining bottom disk after a subtree has been moved.

```

Enter (3 disks): s=A, i=B, d=C
  Enter (2 disks): s=A, i=C, d=B
    Enter (1 disk): s=A, i=B, d=C
      Base case: move disk 1 from A to C
    Return (1 disk)
  Move bottom disk 2 from A to B

  Enter (1 disk): s=C, i=A, d=B
    Base case: move disk 1 from C to B
  Return (1 disk)
Return (2 disks)
Move bottom disk 3 from A to C
Enter (2 disks): s=B, i=A, d=C
  Enter (1 disk): s=B, i=C, d=A
    Base case: move disk 1 from B to A
  Return (1 disk)

```

```
Move bottom disk 2 from B to C
Enter (1 disk): s=A, i=B, d=C
    Base case: move disk 1 from A to C
Return (1 disk)
Return (2 disks)
Return (3 disks)
```

If you study this output along with the source code for `doTower()`, it should become clear exactly how the method works. It's amazing that such a small amount of code can solve such a seemingly complicated problem.

Mergesort

Our final example of recursion is the mergesort. This is a much more efficient sorting technique than those we saw in [Chapter 3, "Simple Sorting,"](#) at least in terms of speed. While the bubble, insertion, and selection sorts take $O(N^2)$ time, the mergesort is $O(N \log N)$. The graph in [Figure 2.9](#) (in Chapter 2) shows how much faster this is. For example, if N (the number of items to be sorted) is 10,000, then N^2 is 100,000,000, while $N \log N$ is only 40,000. If sorting this many items required 40 seconds with the mergesort, it would take almost 28 hours for the insertion sort.

The mergesort is also fairly easy to implement. It's conceptually easier than quicksort and the Shell sort, which we'll encounter in the [next chapter](#).

The downside of the mergesort is that it requires an additional array in memory, equal in size to the one being sorted. If your original array barely fits in memory, the mergesort won't work. However, if you have enough space, it's a good choice.

Merging Two Sorted Arrays

The heart of the mergesort algorithm is the merging of two already sorted arrays. Merging two sorted arrays A and B creates a third array, C , that contains all the elements of A and B , also arranged in sorted order. We'll examine the merging process first; later we'll see how it's used in sorting.

Imagine two sorted arrays. They don't need to be the same size. Let's say array A has 4 elements and array B has 6. They will be merged into an array C that starts with 10 empty cells. Figure 6.14 shows how this looks.

In the figure, the circled numbers indicate the order in which elements are transferred from A and B to C . Table 6.3 shows the comparisons necessary to determine which element will be copied. The steps in the table correspond to the steps in the figure. Following each comparison, the smaller element is copied to A .

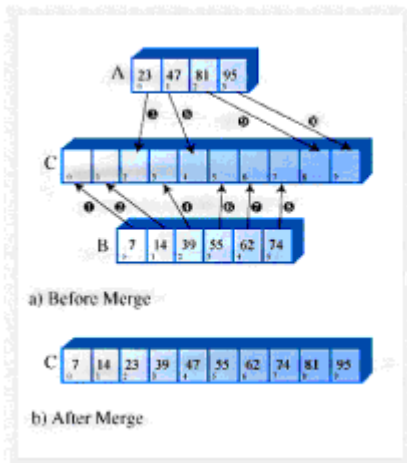

Figure 6.14: Merging two arrays

Table 6.3: Merging Operations

Step	Comparison (If Any)	Copy
1	Compare 23 and 7	Copy 7 from B to C
2	Compare 23 and 14	Copy 14 from B to C
3	Compare 23 and 39	Copy 23 from A to C
4	Compare 39 and 47	Copy 39 from B to C
5	Compare 55 and 47	Copy 47 from A to C
6	Compare 55 and 81	Copy 55 from B to C
7	Compare 62 and 81	Copy 62 from B to C
8	Compare 74 and 81	Copy 74 from B to C
9		Copy 81 from A to C
10		Copy 95 from A to C

Notice that, because B is empty following step 8, no more comparisons are necessary; all the remaining elements are simply copied from A into C.

Listing 6.5 shows a Java program that carries out the merge shown in Figure 6.14 and Table 6.3.

Listing 6.5 The merge.java Program

```
// merge.java
// demonstrates merging two arrays into a third
// to run this program: C>java MergeApp
////////////////////////////////////
class MergeApp
{
    public static void main(String[] args)
    {
        int[] arrayA = {23, 47, 81, 95};
        int[] arrayB = {7, 14, 39, 55, 62, 74};
        int[] arrayC = new int[10];

        merge(arrayA, 4, arrayB, 6, arrayC);
        display(arrayC, 10);
    } // end main()

    //-----
    // merge A and B into C
    public static void merge( int[] arrayA, int sizeA,
                             int[] arrayB, int sizeB,
                             int[] arrayC )
    {
        int aDex=0, bDex=0, cDex=0;

        while(aDex < sizeA && bDex < sizeB) // neither array
empty
        if( arrayA[aDex] < arrayB[bDex] )
            arrayC[cDex++] = arrayA[aDex++];
        else
            arrayC[cDex++] = arrayB[bDex++];

        while(aDex < sizeA) // arrayB is empty,
            arrayC[cDex++] = arrayA[aDex++]; // but arrayA isn't

        while(bDex < sizeB) // arrayA is empty,
            arrayC[cDex++] = arrayB[bDex++]; // but arrayB isn't
    } // end merge()

    //-----
    // display array
    public static void display(int[] theArray, int size)
    {
        for(int j=0; j<size; j++)
            System.out.print(theArray[j] + " ");
        System.out.println("");
    }

    //-----
}
```

```
} // end class MergeApp
```

In `main()` the arrays `arrayA`, `arrayB`, and `arrayC` are created; then the `merge()` method is called to merge `arrayA` and `arrayB` into `arrayC`, and the resulting contents of `arrayC` are displayed. Here's the output:

```
7 14 23 39 47 55 62 74 81 95
```

The `merge()` method has three `while` loops. The first steps along both `arrayA` and `arrayB`, comparing elements and copying the smaller of the two into `arrayC`.

The second `while` loop deals with the situation when all the elements have been transferred out of `arrayB`, but `arrayA` still has remaining elements. (This is what happens in the example, where 81 and 95 remain in `arrayA`.) The loop simply copies the remaining elements from `arrayA` into `arrayC`.

The third loop handles the similar situation when all the elements have been transferred out of `arrayA` but `arrayB` still has remaining elements; they are copied to `arrayC`.

Sorting by Merging

The idea in the mergesort is to divide an array in half, sort each half, and then use the `merge()` method to merge the two halves into a single sorted array. How do you sort each half? This chapter is about recursion, so you probably already know the answer: You divide the half into two quarters, sort each of the quarters, and merge them to make a sorted half.

Similarly, each pair of 8ths is merged to make a sorted quarter, each pair of 16ths is merged to make a sorted 8th, and so on. You divide the array again and again until you reach a subarray with only one element. This is the base case; it's assumed an array with one element is already sorted.

We've seen that generally something is reduced in size each time a recursive method calls itself, and built back up again each time the method returns. In `mergeSort()` the range is divided in half each time this method calls itself, and each time it returns it merges two smaller ranges into a larger one.

As `mergeSort()` returns from finding 2 arrays of 1 element each, it merges them into a sorted array of 2 elements. Each pair of resulting 2-element arrays is then merged into a 4-element array. This process continues with larger and larger arrays until the entire array is sorted. This is easiest to see when the original array size is a power of 2, as shown in Figure 6.15.

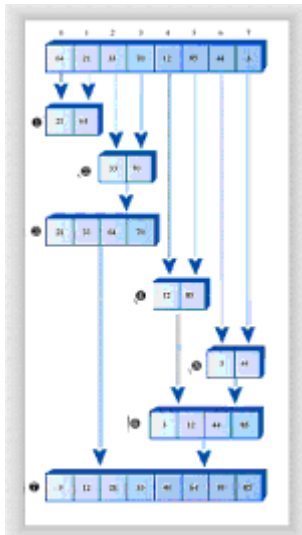

Figure 6.15: Merging larger and larger arrays

First, in the bottom half of the array, range 0-0 and range 1-1 are merged into range 0-1. Of course, 0-0 and 1-1 aren't really ranges; they're only one element, so they are base cases. Similarly, 2-2 and 3-3 are merged into 2-3. Then ranges 0-1 and 2-3 are merged 0-3.

In the top half of the array, 4-4 and 5-5 are merged into 4-5, 6-6 and 7-7 are merged into 6-7, and 4-5 and 6-7 are merged into 4-7. Finally the top half, 0-3, and the bottom half, 4-7, are merged into the complete array, 0-7, which is now sorted.

When the array size is not a power of 2, arrays of different sizes must be merged. For example, Figure 6.16 shows the situation in which the array size is 12. Here an array of size 2 must be merged with an array of size 1 to form an array of size 3.

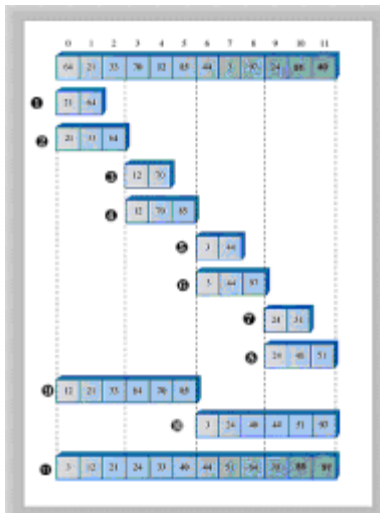

Figure 6.16: Array size not a power of 2

First the 1-element ranges 0-0 and 1-1 are merged into the 2-element range 0-1. Then range 0-1 is merged with the 1-element range 2-2. This creates a 3-element range 0-2. It's merged with the 3-element range 3-5. The process continues until the array is sorted.

Notice that in mergesort we don't merge two separate arrays into a third one, as we

demonstrated in the `merge.java` program. Instead, we merge parts of a single array into itself.

You may wonder where all these subarrays are located in memory. In the algorithm, a workspace array of the same size as the original array is created. The subarrays are stored in sections of the workspace array. This means that subarrays in the original array are copied to appropriate places in the workspace array. After each merge, the workspace array is copied back into the original array.

The MERGESORT Workshop Applet

All this is easier to appreciate when you see it happening before your very eyes. Start up the mergeSort Workshop applet. Repeatedly pressing the Step button will execute mergeSort step by step. Figure 6.17 shows what it looks like after the first three presses.

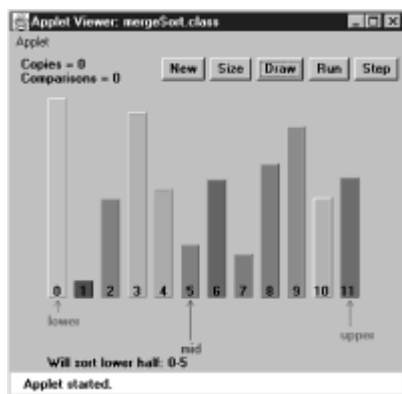

Figure 6.17: The mergeSort Workshop applet

The Lower and Upper arrows show the range currently being considered by the algorithm, and the Mid arrow shows the middle part of the range. The range starts as the entire array and then is halved each time the `mergeSort()` method calls itself. When the range is one element, `mergeSort()` returns immediately; that's the base case. Otherwise, the two subarrays are merged. The applet provides messages, such as `Entering mergeSort: 0-5`, to tell you what it's doing and the range it's operating on.

Many steps involve the `mergeSort()` method calling itself or returning. Comparisons and copies are performed only during the merge process, when you'll see messages such as `Merged 0-0` and `1-1 into workspace`. You can't see the merge happening, because the workspace isn't shown. However, you can see the result when the appropriate section of the workspace is copied back into the original (visible) array: The bars in the specified range will appear in sorted order.

First, the first 2 bars will be sorted, then the first 3 bars, then the 2 bars in the range 3-4, then the 3 bars in the range 3-5, then the 6 bars in the range 0-5, and so on, corresponding to the sequence shown in [Figure 6.16](#). Eventually all the bars will be sorted.

You can cause the algorithm to run continuously by pressing the Run button. You can stop this process at any time by pressing Step, single-step as many times as you want, and resume running by pressing Run again.

As in the other sorting Workshop applets, pressing New resets the array with a new group of unsorted bars and toggles between random and inverse arrangements. The Size button toggles between 12 bars and 100 bars.

It's especially instructive to watch the algorithm run with 100 inversely sorted bars. The

resulting patterns show clearly how each range is sorted individually and merged with its other half, and how the ranges grow larger and larger.

The mergeSort.java Program

In a moment we'll look at the entire `mergeSort.java` program. First, let's focus on the method that carries out the mergesort. Here it is:

```
private void recMergeSort(double[] workspace, int lowerBound,
                          int upperBound)
{
    if(lowerBound == upperBound)           // if range is 1,
        return;                            // no use sorting
    else
    {
        // find midpoint
        int mid = (lowerBound+upperBound) / 2;
        // sort low half
        recMergeSort(workspace, lowerBound, mid);
        // sort high half
        recMergeSort(workspace, mid+1, upperBound);
        // merge them
        merge(workspace, lowerBound, mid+1, upperBound);
    } // end else

} // end recMergeSort
```

As you can see, beside the base case, there are only four statements in this method. One computes the midpoint, there are two recursive calls to `recMergeSort()` (one for each half of the array), and finally a call to `merge()` to merge the two sorted halves. The base case occurs when the range contains only one element (`lowerBound==upperBound`) and results in an immediate return.

In the `mergeSort.java` program, the `mergeSort()` method is the one actually seen by the class user. It creates the array `workspace[]`, and then calls the recursive routine `recMergeSort()` to carry out the sort. The creation of the workspace array is handled in `mergeSort()` because doing it in `recMergeSort()` would cause the array to be created anew with each recursive call, an inefficiency.

The `merge()` method in the previous `merge.java` program operated on three separate arrays: two source arrays and a destination array. The `merge()` routine in the `mergeSort.java` program operates on a single array: the `theArray` member of the `DArray` class. The arguments to this `merge()` method are the starting point of the low-half subarray, the starting point of the high-half subarray, and the upper bound of the high-half subarray. The method calculates the sizes of the subarrays based on this information.

Listing 6.6 shows the complete `mergeSort.java` program. This program uses a variant of the array classes from [Chapter 2](#), adding the `mergeSort()` and `recMergeSort()` methods to the `DArray` class. The `main()` routine creates an array, inserts 12 items, displays the array, sorts the items with `mergeSort()`, and displays the array again.

Listing 6.6 The mergeSort.java Program

```
// mergeSort.java
// demonstrates recursive mergesort
```

```

// to run this program: C>java MergeSortApp
import java.io.*; // for I/O
////////////////////////////////////
class DArray
{
private double[] theArray; // ref to array theArray
private int nElems; // number of data items

//-----
-
public DArray(int max) // constructor
{
theArray = new double[max]; // create array
nElems = 0;
}

//-----
-
public void insert(double value) // put element into array
{
theArray[nElems] = value; // insert it
nElems++; // increment size
}

//-----
-
public void display() // displays array contents
{
for(int j=0; j<nElems; j++) // for each element,
System.out.print(theArray[j] + " "); // display it
System.out.println("");
}

//-----
-
public void mergeSort() // called by main()
{ // provides workspace
double[] workSpace = new double[nElems];
recMergeSort(workSpace, 0, nElems-1);
}

//-----
-
private void recMergeSort(double[] workSpace, int
lowerBound,
int upperBound)
{
if(lowerBound == upperBound) // if range is 1,
return; // no use sorting
else
{ // find midpoint
int mid = (lowerBound+upperBound) / 2;
// sort low half
recMergeSort(workSpace, lowerBound, mid);
}
}
}

```

```

                                                    // sort high half
    recMergeSort(workspace, mid+1, upperBound);
                                                    // merge them
    merge(workspace, lowerBound, mid+1, upperBound);
    } // end else
} // end recMergeSort

//-----
-
private void merge(double[] workspace, int lowPtr,
                  int highPtr, int upperBound)
{
    int j = 0; // workspace index
    int lowerBound = lowPtr;
    int mid = highPtr-1;
    int n = upperBound-lowerBound+1; // # of items

    while(lowPtr <= mid && highPtr <= upperBound)
        if( theArray[lowPtr] < theArray[highPtr] )
            workspace[j++] = theArray[lowPtr++];
        else
            workspace[j++] = theArray[highPtr++];

    while(lowPtr <= mid)
        workspace[j++] = theArray[lowPtr++];

    while(highPtr <= upperBound)
        workspace[j++] = theArray[highPtr++];

    for(j=0; j<n; j++)
        theArray[lowerBound+j] = workspace[j];
    } // end merge()

//-----
-
} // end class DArray

////////////////////////////////////

class MergeSortApp
{
    public static void main(String[] args)
    {
        int maxSize = 100; // array size
        DArray arr; // reference to array
        arr = new DArray(maxSize); // create the array

        arr.insert(64); // insert items
        arr.insert(21);
        arr.insert(33);
        arr.insert(70);
        arr.insert(12);
        arr.insert(85);
    }
}

```

```

arr.insert(44);
arr.insert(3);
arr.insert(99);
arr.insert(0);
arr.insert(108);
arr.insert(36);

arr.display();           // display items

arr.mergeSort();        // mergesort the array

arr.display();          // display items again
} // end main()

} // end class MergeSortApp

```

The output from the program is simply the display of the unsorted and sorted arrays:

```

64 21 33 70 12 85 44 3 99 0 108 36
0 3 12 21 33 36 44 64 70 85 99 108

```

If we put additional statements in the `recMergeSort()` method, we could generate a running commentary on what the program does during a sort. The following output shows how this might look for the 4-item array {64, 21, 33, 70}. (You can think of this as the lower half of the array in [Figure 6.15](#).)

```

Entering 0-3
  Will sort low half of 0-3
    Entering 0-1
      Will sort low half of 0-1
        Entering 0-0
          Base-Case Return 0-0
        Will sort high half of 0-1
          Entering 1-1
            Base-Case Return 1-1
          Will merge halves into 0-1
        Return 0-1
      theArray=21 64 33 70
    Will sort high half of 0-3
      Entering 2-3
        Will sort low half of 2-3
          Entering 2-2
            Base-Case Return 2-2
          Will sort high half of 2-3
            Entering 3-3
              Base-Case Return 3-3
            Will merge halves into 2-3
          Return 2-3
        theArray=21 64 33 70
      Will merge halves into 0-3

Return 0-3
theArray=21 33 64 70

```

This is roughly the same content as would be generated by the mergeSort Workshop applet if it could sort 4 items. Study of this output, and comparison with the code for

recMergeSort() and [Figure 6.15](#), will reveal the details of the sorting process.

Efficiency of the Mergesort

As we noted, the mergesort runs in $O(N \cdot \log N)$ time. How do we know this? Let's see how we can figure out the number of times a data item must be copied, and the number of times it must be compared with another data item, during the course of the algorithm. We assume that copying and comparing are the most time-consuming operations; that the recursive calls and returns don't add much overhead.

Number of Copies

Consider [Figure 6.15](#). Each cell below the top line represents an element copied from the array into the workspace.

Adding up all the cells in [Figure 6.15](#) (the 7 numbered steps) shows there are 24 copies necessary to sort 8 items. $\log_2 8$ is 3, so $8 \cdot \log_2 8$ equals 24. This shows that, for the case of 8 items, the number of copies is proportional to $N \cdot \log_2 N$.

Another way to look at this is that, to sort 8 items requires 3 *levels*, each of which involves 8 copies. A level means all copies into the same size subarray. In the first level, there are 4 2-element subarrays; in the second level, there are 2 4-element subarrays; and in the third level, there is 1 8-element subarray. Each level has 8 elements, so again there are $3 \cdot 8$ or 24 copies.

In [Figure 6.15](#), by considering only half the graph, you can see that 8 copies are necessary for an array of 4 items (steps 1, 2, and 3), and 2 copies are necessary for 2 items. Similar calculations provide the number of copies necessary for larger arrays. Table 6.4 summarizes this information.

Table 6.4: Number of Operations When N is a Power of 2

N	$\log_2 N$	Number of Copies into Workspace ($N \cdot \log_2 N$)	Total Copies	Comparisons Max (Min)
2	1	2	4	1 (1)
4	2	8	16	5 (4)
8	3	24	48	17 (12)
16	4	64	128	49 (32)
32	5	160	320	129 (80)
64	6	384	768	321 (192)
128	7	896	1792	769 (448)

Actually, the items are not only copied into the workspace, they're also copied back into

the original array. This doubles the number of copies, as shown in the Total Copies column. The final column of [Table 6.4](#) shows comparisons, which we'll return to in a moment.

It's harder to calculate the number of copies and comparisons when N is not a multiple of 2, but these numbers fall between those that are a power of 2. For 12 items, there are 88 total copies, and for 100 items, 1344 total copies.

Number of Comparisons

In the mergesort algorithm, the number of comparisons is always somewhat less than the number of copies. How much less? Assuming the number of items is a power of 2, for each individual merging operation, the maximum number of comparisons is always one less than the number of items being merged, and the minimum is half the number of items being merged. You can see why this is true in Figure 6.18, which shows two possibilities when trying to merge 2 arrays of 4 items each.

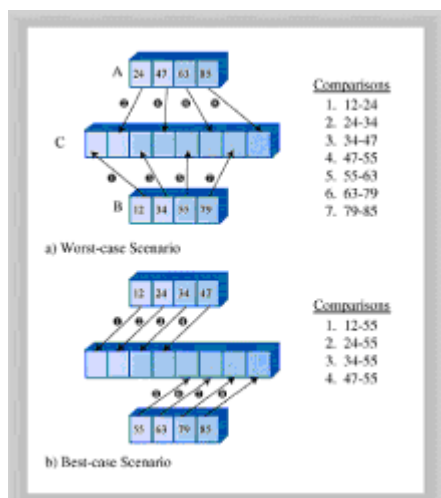

Figure 6.18: Maximum and minimum comparisons

In the first case, the items interleave, and 7 comparisons must be made to merge them. In the second case, all the items in one array are smaller than all the items in the other, so only 4 comparisons must be made.

There are many merges for each sort, so we must add the comparisons for each one. Referring to [Figure 6.15](#), you can see that 7 merge operations are required to sort 8 items. The number of items being merged and the resulting number of comparisons is shown in [Table 6.5](#).

Table 6.5: Comparisons Involved in Sorting 8 Items

Step Number	1	2	3	4	5	6	7	Totals
Number of items being merged(N)	2	2	4	2	2	4	8	24
Maximum comparisons(N-1)	1	1	3	1	1	3	7	17
Minimum	1	1	2	1	1	2	4	12

comparisons(N/2)

For each merge, the maximum number of comparisons is one less than the number of items. Adding these figures for all the merges gives us a total of 17.

The minimum number of comparisons is always half the number of items being merged, and adding these figures for all the merges results in 12 comparisons. Similar arithmetic results in the Comparisons columns for [Table 6.4](#). The actual number of comparisons to sort a specific array depends on how the data is arranged; but it will be somewhere between the maximum and minimum values.

Eliminating Recursion

Some algorithms lend themselves to a recursive approach, some don't. As we've seen, the recursive `triangle()` and `factorial()` methods can be implemented more efficiently using a simple loop. However, various divide-and-conquer algorithms, such as mergesort, work very well as a recursive routine.

Often an algorithm is easy to conceptualize as a recursive method, but in practice the recursive approach proves to be inefficient. In such cases, it's useful to transform the recursive approach into a nonrecursive approach. Such a transformation can often make use of a stack.

Recursion and Stacks

There is a close relationship between recursion and stacks. In fact, most compilers implement recursion by using stacks. As we noted, when a method is called, they push the arguments to the method and the return address (where control will go when the method returns) on the stack, and then transfer control to the method. When the method returns, they pop these values off the stack. The arguments disappear, and control returns to the return address.

Simulating a Recursive Method

In this section we'll demonstrate how any recursive solution can be transformed into a stack-based solution. Remember the recursive `triangle()` method from the first section in this chapter? Here it is again:

```
int triangle(int n)
{
    if(n==1)
        return 1;
    else
        return( n + triangle(n-1) );
}
```

We're going to break this algorithm down into its individual operations, making each operation one `case` in a `switch` statement. (You can perform a similar decomposition using `goto` statements in C++ and some other languages, but Java doesn't support `goto`.)

The `switch` statement is enclosed in a method called `step()`. Each call to `step()` causes one `case` section within the `switch` to be executed. Calling `step()` repeatedly will eventually execute all the code in the algorithm.

The `triangle()` method we just saw performs two kinds of operations. First, it carries out the arithmetic necessary to compute triangular numbers. This involves checking if `n` is 1, and adding `n` to the results of previous recursive calls. However, `triangle()` also performs the operations necessary to manage the method itself. These involve transfer of control, argument access, and the return address. These operations are not visible by looking at the code; they're built into all methods. Here, roughly speaking, is what happens during a call to a method:

- When a method is called, its arguments and the return address are pushed onto a stack.
- A method can access its arguments by peeking at the top of the stack.
- When a method is about to return, it peeks at the stack to obtain the return address, and then pops both this address and its arguments off the stack and discards them.

The `stackTriangle.java` program contains three classes: `Params`, `StackX`, and `StackTriangleApp`. The `Params` class encapsulates the return address and the method's argument, `n`; objects of this class are pushed onto the stack. The `StackX` class is similar to those in other chapters, except that it holds objects of class `Params`. The `StackTriangleApp` class contains four methods: `main()`, `recTriangle()`, `step()`, and the usual `getInt()` method for numerical input.

The `main()` routine asks the user for a number, calls the `recTriangle()` method to calculate the triangular number corresponding to `n`, and displays the result.

The `recTriangle()` method creates a `StackX` object and initializes `codePart` to 1. It then settles into a `while` loop where it repeatedly calls `step()`. It won't exit from the loop until `step()` returns `true` by reaching case 6, its exit point. The `step()` method is basically a large `switch` statement in which each `case` corresponds to a section of code in the original `triangle()` method. Listing 6.7 shows the `stackTriangle.java` program.

Listing 6.7 The `stackTriangle.java` Program

```
// stackTriangle.java
// evaluates triangular numbers, stack replaces recursion
// to run this program: C>java StackTriangleApp
import java.io.*;           // for I/O
////////////////////////////////////
class Params    // parameters to save on stack
{
    public int n;
    public int codePart;

    public Params(int nn, int ra)
    {
        n=nn;
        returnAddress = ra;
    }
} // end class Params

////////////////////////////////////
```

```

class StackX
{
    private int maxSize;          // size of stack array
    private Params[] stackArray;
    private int top;              // top of stack

//-----
-
    public StackX(int s)          // constructor
    {
        maxSize = s;             // set array size
        stackArray = new Params[maxSize]; // create array
        top = -1;                 // no items yet
    }

//-----
-
    public void push(Params p)    // put item on top of stack
    {
        stackArray[++top] = p;    // increment top, insert item
    }

//-----
-
    public Params pop()           // take item from top of stack
    {
        return stackArray[top--]; // access item, decrement top
    }

//-----
-
    public Params peek()         // peek at top of stack
    {
        return stackArray[top];
    }

//-----
-
    } // end class StackX

////////////////////////////////////

class StackTriangleApp
{
    static int theNumber;
    static int theAnswer;
    static StackX theStack;
    static int codePart;
    static Params theseParams;

    public static void main(String[] args) throws IOException
    {
        System.out.print("Enter a number: ");
        System.out.flush();
    }
}

```

```

    theNumber = getInt();
    triangle();
    System.out.println("Triangle="+theAnswer);
} // end main()

//-----
public static void recTriangle()
{
    theStack = new StackX(50);
    codePart = 1;
    while( step() == false) // call step() until it's true
        ; // null statement
}

//-----
public static boolean step()
{
    switch(codePart)
    {
        case 1: // initial call
            theseParams = new Params(theNumber, 6);
            theStack.push(theseParams);
            codePart = 2;
            break;
        case 2: // method entry
            theseParams = theStack.peek();
            if(theseParams.n == 1) // test
            {
                theAnswer = 1;
                codePart = 5; // exit
            }
            else
                codePart = 3; // recursive call
            break;
        case 3: // method call
            Params newParams = new Params(theseParams.n - 1,
4);
            theStack.push(newParams);
            codePart = 2; // go enter method
            break;
        case 4: // calculation
            theseParams = theStack.peek();
            theAnswer = theAnswer + theseParams.n;
            codePart = 5;
            break;
        case 5: // method exit
            theseParams = theStack.peek();
            codePart = theseParams.returnAddress; // (4 or 6)
            theStack.pop();
            break;
        case 6: // return point
            return true;
    } // end switch
}

```

```

return false;                                     // all but 7
} // end triangle

//-----
public static String getString() throws IOException
{
    InputStreamReader isr = new InputStreamReader(System.in);
    BufferedReader br = new BufferedReader(isr);
    String s = br.readLine();
    return s;
}

//-----
-
public static int getInt() throws IOException
{
    String s = getString();
    return Integer.parseInt(s);
}

//-----
-

} // end class StackTriangleApp

```

This program calculates triangular numbers, just as the `triangle.java` program at the beginning of the chapter did. Here's some sample output:

```

Enter a number: 100
Triangle=5050

```

Figure 6.19 shows how the sections of code in each `case` relate to the various parts of the algorithm.

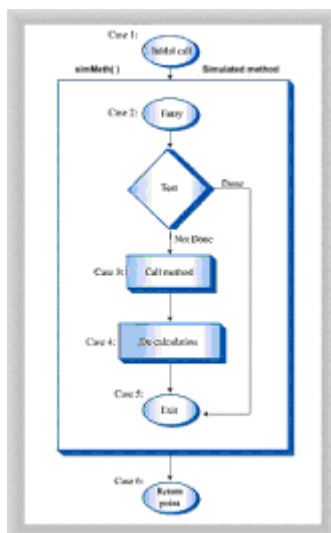

Figure 6.19: The `cases` and the `step()` method

The program simulates a method, but it has no name in the listing because it isn't a real

Java method. Let's call this simulated method `simMeth()`. The initial call to `simMeth()` (at case 1) pushes the value entered by the user and a return value of 6 onto the stack and moves to the entry point of `simMeth()` (case 2).

At its entry (case 2), `simMeth()` tests whether its argument is 1. It accesses the argument by peeking at the top of the stack. If the argument is 1, this is the base case and control goes to `simMeth()`'s exit (case 5). If not, it calls itself recursively (case 3). This recursive call consists of pushing $n-1$ and a return address of 4 onto the stack, and going to the method entry at case 2.

On the return from the recursive call, `simMeth()` adds its argument n to the value returned from the call. Finally it exits (case 5). When it exits, it pops the last `Params` object off the stack; this information is no longer needed.

The return address given in the initial call was 6, so case 6 is where control goes when the method returns. This code returns `true` to let the `while` loop in `recTriangle()` know that the loop is over.

Note that in this description of `simMeth()`'s operation we use terms like *argument*, *recursive call*, and *return address* to mean simulations of these features, not the normal Java versions.

If you inserted some output statements in each case to see what `simMeth()` was doing, you could arrange for output like this:

```
Enter a number: 4
case 1. theAnswer=0 Stack:
case 2. theAnswer=0 Stack: (4, 6)
case 3. theAnswer=0 Stack: (4, 6)
case 2. theAnswer=0 Stack: (4, 6) (3, 4)
case 3. theAnswer=0 Stack: (4, 6) (3, 4)
case 2. theAnswer=0 Stack: (4, 6) (3, 4) (2, 4)
case 3. theAnswer=0 Stack: (4, 6) (3, 4) (2, 4)
case 2. theAnswer=0 Stack: (4, 6) (3, 4) (2, 4) (1, 4)
case 5. theAnswer=1 Stack: (4, 6) (3, 4) (2, 4) (1, 4)
case 4. theAnswer=1 Stack: (4, 6) (3, 4) (2, 4)
case 5. theAnswer=3 Stack: (4, 6) (3, 4) (2, 4)
case 4. theAnswer=3 Stack: (4, 6) (3, 4)
case 5. theAnswer=6 Stack: (4, 6) (3, 4)
case 4. theAnswer=6 Stack: (4, 6)
case 5. theAnswer=10 Stack: (4, 6)
case 6. theAnswer=10 Stack:
Triangle=10
```

The case number shows what section of code is being executed. The contents of the stack (consisting of `Params` objects containing n followed by a return address) are also shown. The `simMeth()` method is entered 4 times (case 2) and returns 4 times (case 5). It's only when it starts returning that `theAnswer` begins to accumulate the results of the calculations.

What Does This Prove?

In `stackTriangle.java` we have a program that more or less systematically transforms a program that uses recursion into a program that uses a stack. This suggests that such a transformation is possible for any program that uses recursion, and in fact this is the case.

With some additional work, you can systematically refine the code we show here, simplifying it and even eliminating the `switch` statement entirely to make the code more efficient.

In practice, however, it's usually more practical to rethink the algorithm from the beginning, using a stack-based approach instead of a recursive approach. Listing 6.8 shows what happens when we do that with the `triangle()` method.

Listing 6.8 The `stackTriangle2.java` Program

```
// stackTriangle2.java
// evaluates triangular numbers, stack replaces recursion
// to run this program: C>java StackTriangle2App
import java.io.*;           // for I/O
////////////////////////////////////
class StackX
{
    private int maxSize;      // size of stack array
    private int[] stackArray;
    private int top;         // top of stack

//-----
-
    public StackX(int s)      // constructor
    {
        maxSize = s;
        stackArray = new int[maxSize];
        top = -1;
    }

//-----
-
    public void push(int p)   // put item on top of stack
        { stackArray[++top] = p; }

//-----
-
    public int pop()          // take item from top of stack
        { return stackArray[top--]; }

//-----
-
    public int peek()         // peek at top of stack
        { return stackArray[top]; }

//-----
-
    public boolean isEmpty() // true if stack is empty
        { return (top == -1); }

//-----
-
} // end class StackX
```

```

////////////////////////////////////
class StackTriangle2App
{
    static int theNumber;
    static int theAnswer;
    static StackX theStack;

    public static void main(String[] args) throws IOException
    {
        System.out.print("Enter a number: ");
        System.out.flush();
        theNumber = getInt();
        stackTriangle();
        System.out.println("Triangle="+theAnswer);
    } // end main()

//-----
    public static void stackTriangle()
    {
        theStack = new StackX(10000); // make a stack

        theAnswer = 0; // initialize answer

        while(theNumber > 0) // until n is 1,
        {
            theStack.push(theNumber); // push value
            --theNumber; // decrement value
        }
        while( !theStack.isEmpty() ) // until stack empty,
        {
            int newN = theStack.pop(); // pop value,
            theAnswer += newN; // add to answer
        }
    }

//-----
    public static String getString() throws IOException
    {
        InputStreamReader isr = new InputStreamReader(System.in);
        BufferedReader br = new BufferedReader(isr);
        String s = br.readLine();
        return s;
    }

//-----
    public static int getInt() throws IOException
    {
        String s = getString();
        return Integer.parseInt(s);
    }
}

```

```
//-----  
  
    } // end class StackTriangle2App
```

Here two short `while` loops in the `stackTriangle()` method substitute for the entire `step()` method of the `stackTriangle.java` program. Of course, in this program you can see by inspection that you can eliminate the stack entirely and use a simple loop. However, in more complicated algorithms the stack must remain.

Often you'll need to experiment to see whether a recursive method, a stack-based approach, or a simple loop is the most efficient (or practical) way to handle a particular situation.

Part III

Chapter List

[Chapter 7:](#) [Advanced Sorting](#)

[Chapter 8:](#) [Binary Trees](#)

[Chapter 9:](#) [Red-Black Trees](#)

Chapter 7: **Advanced Sorting**

Overview

We discussed simple sorting in [Chapter 3](#). The sorts described there—the bubble, selection, and insertion sorts—are easy to implement but are rather slow. In [Chapter 6](#) we described the mergesort. It runs much faster than the simple sorts, but requires twice as much space as the original array; this is often a serious drawback.

This chapter covers two advanced approaches to sorting: Shellsort and quicksort. These sorts both operate much faster than the simple sorts; the Shellsort in about $O(N \cdot (\log N)^2)$ time, and quicksort in $O(N \cdot \log N)$ time, which is the fastest time for general-purpose sorts. Neither of these sorts requires a large amount of extra space, as mergesort does. The Shellsort is almost as easy to implement as mergesort, while quicksort is the fastest of all the general-purpose sorts.

We'll examine the Shellsort first. Quicksort is based on the idea of partitioning, so we'll then examine partitioning separately, before examining quicksort itself.

Shellsort

The Shellsort is named for Donald L. Shell, the computer scientist who discovered it in 1959. It's based on the insertion sort but adds a new feature that dramatically improves the insertion sort's performance.

The Shellsort is good for medium-sized arrays, perhaps up to a few thousand items, depending on the particular implementation. (However, see the cautionary notes in [Chapter 15](#) about how much data can be handled by a particular algorithm.) It's not quite

as fast as quicksort and other $O(N \log N)$ sorts, so it's not optimum for very large files. However, it's much faster than the $O(N^2)$ sorts like the selection sort and the insertion sort, and it's very easy to implement: the code is short and simple.

The worst-case performance is not significantly worse than the average performance. (We'll see later in this chapter that the worst-case performance for quicksort can be much worse unless precautions are taken.) Some experts (see Sedgewick in the bibliography) recommend starting with a Shellsort for almost any sorting project, and only changing to a more advanced sort, like quicksort, if Shellsort proves too slow in practice.

Insertion Sort: Too Many Copies

Because Shellsort is based on the insertion sort, you might want to review the relevant section of [Chapter 3](#). Recall that partway through the insertion sort the items to the left of a marker are internally sorted (sorted among themselves) and items to the right are not. The algorithm removes the item at the marker and stores it in a temporary variable. Then, beginning with the item to the left of the newly vacated cell, it shifts the sorted items right one cell at a time, until the item in the temporary variable can be reinserted in sorted order.

Here's the problem with the insertion sort. Suppose a small item is on the far right, where the large items should be. To move this small item to its proper place on the left, all the intervening items (between where it is and where it should be) must be shifted one space right. This is close to N copies, just for one item. Not all the items must be moved a full N spaces, but the average item must be moved $N/2$ spaces, which takes N times $N/2$ shifts for a total of $N^2/2$ copies. Thus the performance of insertion sort is $O(N^2)$.

This performance could be improved if we could somehow move a smaller item many spaces to the left without shifting all the intermediate items individually.

N-Sorting

The Shellsort achieves these large shifts by insertion-sorting widely spaced elements. Once these are sorted, it sorts somewhat less widely spaced elements, and so on. The spacing between elements for these sorts is called the *increment* and is traditionally represented by the letter h . Figure 7.1 shows the first step in the process of sorting a 10-element array with an increment of 4. Here the elements 0, 4, and 8 are sorted.

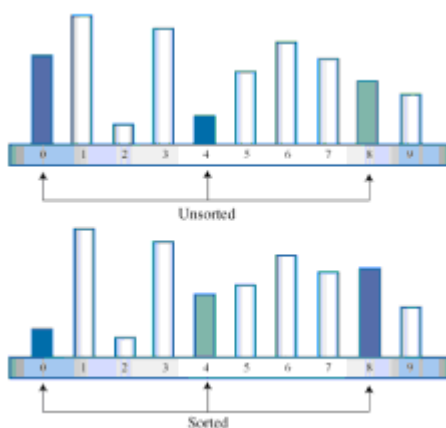

Figure 7.1: 4-sorting 0, 4, and 8

Once 0, 4, and 8 are sorted, the algorithm shifts over one cell and sorts 1, 5, and 9. This process continues until all the elements have been *4-sorted*, which means that all items spaced 4 cells apart are sorted among themselves. The process is shown (using a more

compact visual metaphor) in Figure 7.2.

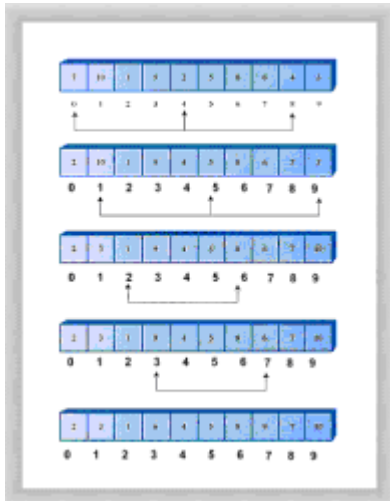

Figure 7.2: A complete 4-sort

After the complete 4-sort, the array can be thought of as comprising four subarrays: (0,4,8), (1,5,9), (2,6), and (3,7), each of which is completely sorted. These subarrays are interleaved, but otherwise independent.

Notice that, in this particular example, at the end of the 4-sort no item is more than 2 cells from where it would be if the array were completely sorted. This is what is meant by an array being "almost" sorted and is the secret of the Shellsort. By creating interleaved, internally sorted sets of items, we minimize the amount of work that must be done to complete the sort.

Now, as we noted in [Chapter 3](#), the insertion sort is very efficient when operating on an array that's almost sorted. If it only needs to move items one or two cells to sort the file, it can operate in almost $O(N)$ time. Thus after the array has been 4-sorted, we can 1-sort it using the ordinary insertion sort. The combination of the 4-sort and the 1-sort is much faster than simply applying the ordinary insertion sort without the preliminary 4-sort.

Diminishing Gaps

We've shown an initial interval—or gap—of 4 cells for sorting a 10-cell array. For larger arrays the gap should start out much larger. The interval is then repeatedly reduced until it becomes 1.

For instance, an array of 1,000 items might be 364-sorted, then 121-sorted, then 40-sorted, then 13-sorted, then 4-sorted, and finally 1-sorted. The sequence of numbers used to generate the intervals (in this example 364, 121, 40, 13, 4, 1) is called the *interval sequence* or *gap sequence*. The particular interval sequence shown here, attributed to Knuth (see the bibliography), is a popular one. In reversed form, starting from 1, it's generated by the recursive expression

$$h = 3 * h + 1$$

where the initial value of h is 1. The first two columns of Table 7.1 show how this formula generates the sequence.

Table 7.1: Knuth's Interval Sequence



h	3*h + 1	(h-1) / 3
1	4	
4	13	1
13	40	4
40	121	13
121	364	40
364	1093	121
1093	3280	364

There are other approaches to generating the interval sequence; we'll return to this issue later. First, we'll explore how the Shellsort works using Knuth's sequence.

In the sorting algorithm, the sequence-generating formula is first used in a short loop to figure out the initial gap. A value of 1 is used for the first value of h, and the $h=3h+1$ formula is applied to generate the sequence 1, 4, 13, 40, 121, 364, and so on. This process ends when the gap is larger than the array. For a 1,000-element array, the 7th number in the sequence, 1093, is too large. Thus we begin the sorting process with the 6th-largest number, creating a 364-sort. Then, each time through the outer loop of the sorting routine, we reduce the interval using the inverse of the formula previously given:

$$h = (h-1) / 3$$

This is shown in the third column of Table 7.1. This inverse formula generates the reverse sequence 364, 121, 40, 13, 4, 1. Starting with 364, each of these numbers is used to n-sort the array. When the array has been 1-sorted, the algorithm is done.

The ShellSort Workshop Applet

You can use the ShellSort Workshop applet to see how this sort works. Figure 7.3 shows the applet after all the bars have been 4-sorted, just as the 1-sort begins.

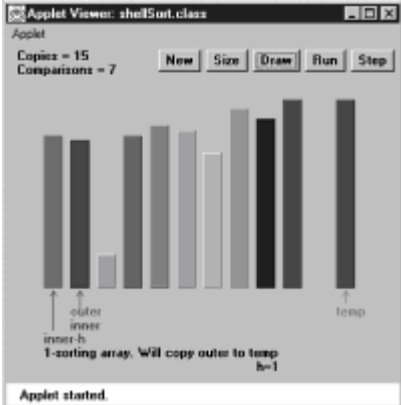

Figure 7.3: The Shellsort Workshop applet

As you single-step through the algorithm, you'll notice that the explanation we gave in the last section is slightly simplified. The sequence for the 4-sort is not actually (0,4,8), (1,5,9), (2,6), and (3,7). Instead the first two elements of each group of three are sorted first, then the first two elements of the second group, and so on. Once the first two elements of all the groups are sorted, the algorithm returns and sorts three-element groups. The actual sequence is (0,4), (1,5), (2,6), (3,7), (0,4,8), (1,5,9).

It might seem more obvious for the algorithm to 4-sort each complete subarray first: (0,4), (0,4,8), (1,5), (1,5,9), (2,6), (3,7), but the algorithm handles the array indices more efficiently using the first scheme.

The Shellsort is actually not very efficient with only 10 items, making almost as many swaps and comparisons as the insertion sort. However, with 100 bars the improvement becomes significant.

It's instructive to run the Workshop applet starting with 100 inversely sorted bars. (Remember that, as in [Chapter 3](#), the first press of New creates a random sequence of bars, while the second press creates an inversely sorted sequence.) Figure 7.4 shows how this looks after the first pass, when the array has been completely 40-sorted. Figure 7.5 shows the situation after the next pass, when it is 13-sorted. With each new value of h , the array becomes more nearly sorted.

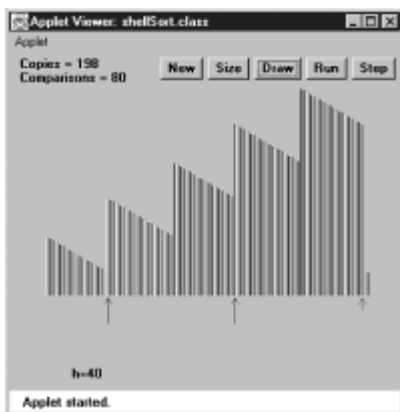

Figure 7.4: After the 40-sort

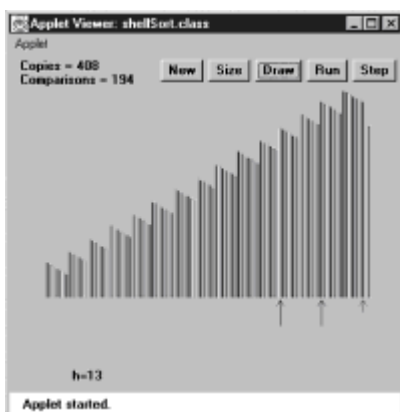

Figure 7.5: After the 13-sort

Why is the Shellsort so much faster than the insertion sort, on which it's based? When h is large, the number of items per pass is small, and items move long distances. This is very efficient. As h grows smaller, the number of items per pass increases, but the items are already closer together, which is more efficient for the insertion sort. It's the combination of these trends that makes the Shellsort so effective.

Notice that later sorts (small values of h) don't undo the work of earlier sorts (large values of h). An array that has been 40-sorted remains 40-sorted after a 13-sort, for example. If this wasn't so the Shellsort couldn't work.

Java Code for the ShellSort

The Java code for the Shellsort is scarcely more complicated than for the insertion sort. Starting with the insertion sort, you substitute h for 1 in appropriate places and add the formula to generate the interval sequence. We've made `shellSort()` a method in the `ArraySh` class, a version of the array classes from [Chapter 2](#). Listing 7.1 shows the complete `shellSort.java` program.

Listing 7.1 The shellSort.java Program

```
// shellSort.java
// demonstrates shell sort
// to run this program: C>java ShellSortApp
//-----
-
class ArraySh
{
    private double[] theArray;        // ref to array theArray
    private int nElems;               // number of data items

//-----
-
    public ArraySh(int max)           // constructor
    {
        theArray = new double[max];   // create the array
        nElems = 0;                   // no items yet
    }

//-----
-
    public void insert(double value)  // put element into array
    {
        theArray[nElems] = value;     // insert it
        nElems++;                     // increment size
    }

//-----
-
    public void display()             // displays array contents
    {
        System.out.print("A=");
        for(int j=0; j<nElems; j++)   // for each element,
            System.out.print(theArray[j] + " "); // display it
        System.out.println("");
    }
}
```



```

//-----
-
public void shellSort()
{
    int inner, outer;
    double temp;

    int h = 1;                // find initial value of h
    while(h <= nElems/3)
        h = h*3 + 1;        // (1, 4, 13, 40, 121,
...)

    while(h>0)                // decreasing h, until h=1
    {
                                // h-sort the file
        for(outer=h; outer<nElems; outer++)
        {
            temp = theArray[outer];
            inner = outer;

8)                                // one subpass (eg 0, 4,
            while(inner > h-1 && theArray[inner-h] >= temp)
            {
                theArray[inner] = theArray[inner-h];
                inner -= h;
            }
            theArray[inner] = temp;
        } // end for
        h = (h-1) / 3;        // decrease h
    } // end while(h>0)
} // end shellSort()

//-----
-
} // end class ArraySh

////////////////////////////////////

class ShellSortApp
{
    public static void main(String[] args)
    {
        int maxSize = 10;    // array size
        ArraySh arr;
        arr = new ArraySh(maxSize); // create the array

        for(int j=0; j<maxSize; j++) // fill array with
        {                               // random numbers
            double n = (int)(java.lang.Math.random()*99);
            arr.insert(n);
        }
        arr.display();        // display unsorted array
        arr.shellSort();     // shell sort the array
    }
}

```

```

        arr.display();                // display sorted array
    } // end main()

} // end class ShellSortApp

```

In `main()` we create an object of type `ArraySh`, capable of holding 10 items, fill it with random data, display it, Shellsort it, and display it again. Here's some sample output:

```

A=20 89 6 42 55 59 41 69 75 66
A=6 20 41 42 55 59 66 69 75 89

```

You can change `maxSize` to higher numbers, but don't go too high; 10,000 items take a fraction of a minute to sort.

The Shellsort algorithm, although it's implemented in just a few lines, is not simple to follow. To see the details of its operation, step through a 10-item sort with the Workshop applet, comparing the messages generated by the applet with the code in the `shellSort()` method.

Other Interval Sequences

Picking an interval sequence is a bit of a black art. Our discussion so far used the formula $h=h*3+1$ to generate the interval sequence, but other interval sequences have been used with varying degrees of success. The only absolute requirement is that the diminishing sequence ends with 1, so the last pass is a normal insertion sort.

In Shell's original paper, he suggested an initial gap of $N/2$, which was simply divided in half for each pass. Thus the descending sequence for $N=100$ is 50, 25, 12, 6, 3, 1. This approach has the advantage that you don't need to calculate the sequence before the sort begins to find the initial gap; you just divide N by 2. However, this turns out not to be the best sequence. Although it's still better than the insertion sort for most data, it sometimes degenerates to $O(N^2)$ running time, which is no better than the insertion sort.

A better approach is to divide each interval by 2.2 instead of 2. For $n=100$ this leads to 45, 20, 9, 4, 1. This is considerably better than dividing by 2, as it avoids some worst-case circumstances that lead to $O(N^2)$ behavior. Some extra code is needed to ensure that the last value in the sequence is 1, no matter what N is. This gives results comparable to Knuth's sequence shown in the listing.

Another possibility for a descending sequence (from Flamig; see [Appendix B, "Further Reading"](#)) is

```

if(h < 5)
    h = 1;
else
    h = (5*h-1) / 11;

```

It's generally considered important that the numbers in the interval sequence are relatively prime; that is, they have no common divisors except 1. This makes it more likely that each pass will intermingle all the items sorted on the previous pass. The inefficiency of Shell's original $N/2$ sequence is due to its failure to adhere to this rule.

You may be able to invent a gap sequence of your own that does just as well (or possibly even better) than those shown. Whatever it is, it should be quick to calculate so as not to slow down the algorithm.

Efficiency of the ShellSort

No one so far has been able to analyze the Shellsort's efficiency theoretically, except in special cases. Based on experiments, there are various estimates, which range from $O(N^{3/2})$ down to $O(N^{7/6})$.

Table 7.2 shows some of these estimated $O()$ values, compared with the slower insertion sort and the faster quicksort. The theoretical times corresponding to various values of N are shown. Note that $N \text{ ex/y}$ means the y th root of N raised to the x power. Thus if N is 100, $N^{3/2}$ is the square root of 100^3 , which is 1,000. Also, $(\log N)^2$ means the log of N , squared. This is often written $\log_2 N$, but that's easy to confuse with $\log_2 N$, the logarithm to the base 2 of N .

Table 7.2: Estimates of ShellSort Running Time

O() Value	Type of Sort	10 Items	100 Items	1,000 Items	10,000 Items
N^2	Insertion, etc.	100	10,000	1,000,000	100,000,000
$N^{3/2}$	Shellsort	32	1,000	32,000	1,000,000
$N * (\log N)^2$	Shellsort	10	400	9,000	160,000
$N^{5/4}$	Shellsort	18	316	5,600	100,000
$N^{7/6}$	Shellsort	14	215	3,200	46,000
$N * \log N$	Quicksort, etc.	10	200	3,000	40,000

For most data the higher estimates, such as $N^{3/2}$, are probably more realistic.

Partitioning

Partitioning is the underlying mechanism of quicksort, which we'll explore next, but it's also a useful operation on its own, so we'll cover it here in its own section.

To *partition* data is to divide it into two groups, so that all the items with a key value higher than a specified amount are in one group, and all the items with a lower key value are in another.

It's easy to imagine situations in which you would want to partition data. Maybe you want to divide your personnel records into two groups: employees who live within 15 miles of the office and those who live farther away. Or a school administrator might want to divide students into those with grade point averages higher and lower than 3.5, so as to know who deserves to be on the Dean's list.

The Partition Workshop Applet

Our Partition Workshop applet demonstrates the partitioning process. Figure 7.6 shows 12 bars before partitioning, and Figure 7.7 shows them again after partitioning.



Figure 7.6: Twelve bars before partitioning

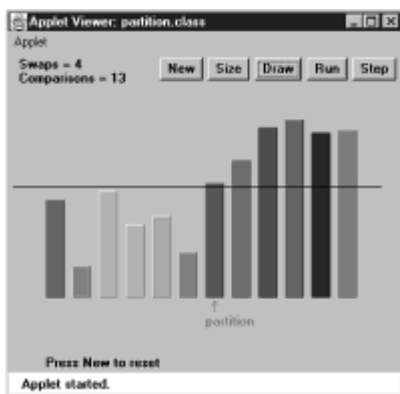

Figure 7.7: Twelve bars after partitioning

The horizontal line represents the *pivot value*. This is the value used to determine into which of the two groups an item is placed. Items with a key value less than the pivot value go in the left part of the array, and those with a greater (or equal) key go in the right part. (In the section on [quicksort](#), we'll see that the pivot value can be the key value of an actual data item, called the *pivot*. For now, it's just a number.)

The arrow labeled *partition* points to the leftmost item in the right (higher) subarray. This value is returned from the partitioning method, so it can be used by other methods that need to know where the division is.

For a more vivid display of the partitioning process, set the Partition Workshop applet to 100 bars and press the Run button. The `leftScan` and `rightScan` pointers will zip toward each other, swapping bars as they go. When they meet, the partition is complete.

You can choose any value you want for the pivot value, depending on why you're doing the partition (such as choosing a grade point average of 3.5). For variety, the Workshop applet chooses a random number for the pivot value (the horizontal black line) each time New or Size is pressed, but the value is never too far from the average bar height.

After being partitioned, the data is by no means sorted; it has simply been divided into two groups. However, it's more sorted than it was before. As we'll see in the next section, it doesn't take much more trouble to sort it completely.

Notice that partitioning is not *stable*. That is, each group is not in the same order it was originally. In fact, partitioning tends to reverse the order of some of the data in each group.

The partition.java Program

How is the partitioning process carried out? Let's look at some sample code. Listing 7.2 shows the `partition.java` program, which includes the `partitionIt()` method for partitioning an array.

Listing 7.2 The partition.java Program

```
// partition.java
// demonstrates partitioning an array
// to run this program: C>java PartitionApp
////////////////////////////////////
class ArrayPar
{
    private double[] theArray;      // ref to array theArray
    private int nElems;            // number of data items

//-----
-
    public ArrayPar(int max)        // constructor
    {
        theArray = new double[max]; // create the array
        nElems = 0;                // no items yet
    }

//-----
-
    public void insert(double value) // put element into array
    {
        theArray[nElems] = value;   // insert it
        nElems++;                  // increment size
    }

//-----
-
    public int size()              // return number of items
    { return nElems; }

//-----
-
    public void display()          // displays array contents
    {
        System.out.print("A=");
        for(int j=0; j<nElems; j++) // for each element,
            System.out.print(theArray[j] + " "); // display it
        System.out.println("");
    }

//-----
-
}
```

```

public int partitionIt(int left, int right, double pivot)
{
    int leftPtr = left - 1;           // right of first elem
    int rightPtr = right + 1;        // left of pivot
    while(true)
    {
        while(leftPtr < right &&    // find bigger item
               theArray[++leftPtr] < pivot)
            ; // (nop)

        while(rightPtr > left &&    // find smaller item
               theArray[--rightPtr] > pivot)
            ; // (nop)
        if(leftPtr >= rightPtr)     // if pointers cross,
            break;                  // partition done
        else                         // not crossed, so
            swap(leftPtr, rightPtr); // swap elements
    } // end while(true)
    return leftPtr;                 // return partition
} // end partitionIt()

//-----
-
public void swap(int dex1, int dex2) // swap two elements
{
    double temp;
    temp = theArray[dex1];           // A into temp
    theArray[dex1] = theArray[dex2]; // B into A
    theArray[dex2] = temp;           // temp into B
} // end swap()

//-----
-
} // end class ArrayPar

////////////////////////////////////

class PartitionApp
{
    public static void main(String[] args)
    {
        int maxSize = 16;           // array size
        ArrayPar arr;               // reference to array
        arr = new ArrayPar(maxSize); // create the array

        for(int j=0; j<maxSize; j++) // fill array with
        {                             // random numbers
            double n = (int)(java.lang.Math.random()*199);
            arr.insert(n);
        }
        arr.display();              // display unsorted array

        double pivot = 99;          // pivot value
    }
}

```

```

    System.out.print("Pivot is " + pivot);
    int size = arr.size();

                                // partition array
    int partDex = arr.partitionIt(0, size-1, pivot);

    System.out.println(", Partition is at index " + partDex);
    arr.display();                // display sorted array
} // end main()

} // end class PartitionApp

```

The `main()` routine creates an `ArrayPar` object that holds 16 items of type `double`. The pivot value is fixed at 99. The routine inserts 16 random values into `ArrayPar`, displays them, partitions them by calling the `partitionIt()` method, and displays them again. Here's some sample output:

```

A=149 192 47 152 159 195 61 66 17 167 118 64 27 80 30 105
Pivot is 99, partition is at index 8
A=30 80 47 27 64 17 61 66 195 167 118 159 152 192 149 105

```

You can see that the partition is successful: The first eight numbers are all smaller than the pivot value of 99; the last eight are all larger.

Notice that the partitioning process doesn't necessarily divide the array in half as it does in this example; that depends on the pivot value and key values of the data. There may be many more items in one group than in the other.

The Partition Algorithm

The partitioning algorithm works by starting with two pointers, one at each end of the array. (We use the term *pointers* to mean indices that point to array elements, not C++ pointers.) The pointer on the left, `leftPtr`, moves toward the right, and the one on the right, `rightPtr`, moves toward the left. Notice that `leftPtr` and `rightPtr` in the `partition.java` program correspond to `leftScan` and `rightScan` in the Partition Workshop applet.

Actually `leftPtr` is initialized to one position to the left of the first cell, and `rightPtr` to one position to the right of the last cell, because they will be incremented and decremented, respectively, before they're used.

Stopping and Swapping

When `leftPtr` encounters a data item smaller than the pivot value, it keeps going, because that item is in the right place. However, when it encounters an item larger than the pivot value, it stops. Similarly, when `rightPtr` encounters an item larger than the pivot, it keeps going, but when it finds a smaller item, it also stops. Two inner `while` loops, the first for `leftPtr` and the second for `rightPtr`, control the scanning process. A pointer stops because its `while` loop exits. Here's a simplified version of the code that scans for out-of-place items:

```

while( theArray[++leftPtr] < pivot ) // find bigger item
    ; // (nop)
while( theArray[--rightPtr] > pivot ) // find smaller item
    ; // (nop)
swap(leftPtr, rightPtr);           // swap elements

```

The first `while` loop exits when an item larger than `pivot` is found; the second loop exits when an item smaller than `pivot` is found. When both these loops exit, both `leftPtr` and `rightPtr` point to items that are in the wrong part of the array, so these items are swapped.

After the swap, the two pointers continue on, again stopping at items that are in the wrong part of the array and swapping them. All this activity is nested in an outer `while` loop, as can be seen in the `partitionIt()` method in Listing 7.2. When the two pointers eventually meet, the partitioning process is complete and this outer `while` loop exits.

You can watch the pointers in action when you run the Partition Workshop applet with 100 bars. These pointers, represented by blue arrows, start at opposite ends of the array and move toward each other, stopping and swapping as they go. The bars between them are unpartitioned; those they've already passed over are partitioned. When they meet, the entire array is partitioned.

Handling Unusual Data

If we were sure that there was a data item at the right end of the array that was smaller than the pivot value, and an item at the left end that was larger, the simplified `while` loops previously shown would work fine. Unfortunately, the algorithm may be called upon to partition data that isn't so well organized.

If all the data is smaller than the pivot value, for example, the `leftPtr` variable will go all the way across the array, looking in vain for a larger item, and fall off the right end, creating an `array index out of bounds` exception. A similar fate will befall `rightPtr` if all the data is larger than the pivot value.

To avoid these problems, extra tests must be placed in the `while` loops to check for the ends of the array: `leftPtr < right` in the first loop, and `rightPtr > left` in the second. This can be seen in context in Listing 7.2.

In the section on [quicksort](#), we'll see that a clever pivot-selection process can eliminate these end-of-array tests. Eliminating code from inner loops is always a good idea if you want to make a program run faster.

Delicate Code

The code in the `while` loops is rather delicate. For example, you might be tempted to remove the increment operators from the inner `while` loops and use them to replace the `nop` statements. (Nop refers to a statement consisting only of a semicolon, and means *no operation*.) For example, you might try to change this:

```
while(leftPtr < right && theArray[++leftPtr] < pivot)
    ; // (nop)
```

to this:

```
while(leftPtr < right && theArray[leftPtr] < pivot)
    ++leftPtr;
```

and similarly for the other inner `while` loop. This would make it possible for the initial values of the pointers to be `left` and `right`, which is somewhat clearer than `left-1` and `right+1`.

However, these changes result in the pointers being incremented only when the condition

is satisfied. The pointers must move in any case, so two extra statements within the outer `while` loop would be required to bump the pointers. The nop version is the most efficient solution.

Efficiency of the Partition Algorithm

The partition algorithm runs in $O(N)$ time. It's easy to see this when running the Partition Workshop applet: the two pointers start at opposite ends of the array and move toward each other at a more or less constant rate, stopping and swapping as they go. When they meet, the partition is complete. If there were twice as many items to partition, the pointers would move at the same rate, but they would have twice as far to go (twice as many items to compare and swap), so the process would take twice as long. Thus the running time is proportional to N .

More specifically, for each partition there will be $N+1$ or $N+2$ comparisons. Every item will be encountered and used in a comparison by one or the other of the pointers, leading to N comparisons, but the pointers overshoot each other before they find out they've "crossed" or gone beyond each other, so there are one or two extra comparisons before the partition is complete. The number of comparisons is independent of how the data is arranged (except for the uncertainty between 1 and 2 extra comparisons at the end of the scan).

The number of swaps, however, does depend on how the data is arranged. If it's inversely ordered and the pivot value divides the items in half, then every pair of values must be swapped, which is $N/2$ swaps. (Remember in the Partition Workshop applet that the pivot value is selected randomly, so that the number of swaps for inversely sorted bars won't always be exactly $N/2$.)

For random data, there will be fewer than $N/2$ swaps in a partition, even if the pivot value is such that half the bars are shorter and half are taller. This is because some bars will already be in the right place (short bars on the left, tall bars on the right). If the pivot value is higher (or lower) than most of the bars, there will be even fewer swaps because only those few bars that are higher (or lower) than the pivot will need to be swapped. On average, for random data, about half the maximum number of swaps take place.

Although there are fewer swaps than comparisons, they are both proportional to N . Thus the partitioning process runs in $O(N)$ time. Running the Workshop applet, you can see that for 12 random bars there are about 3 swaps and 14 comparisons, and for 100 random bars there are about 25 swaps and 102 comparisons.

Quicksort

Quicksort is undoubtedly the most popular sorting algorithm, and for good reason: in the majority of situations, it's the fastest, operating in $O(N \log N)$ time. (This is only true for *internal* or in-memory sorting; for sorting data in disk files other methods may be better.) Quicksort was discovered by C.A.R. Hoare in 1962.

To understand quicksort, you should be familiar with the partitioning algorithm described in the last section. Basically the quicksort algorithm operates by partitioning an array into two subarrays, and then calling itself to quicksort each of these subarrays. However, there are some embellishments we can make to this basic scheme. These have to do with the selection of the pivot and the sorting of small partitions. We'll examine these refinements after we've looked at a simple version of the main algorithm.

It's difficult to understand what quicksort is doing before you understand how it does it, so we'll reverse our usual presentation and show the Java code for quicksort before presenting the quicksort Workshop applet.

The Quicksort Algorithm

The code for a basic recursive quicksort method is fairly simple. Here's an example:

```
public void recQuickSort(int left, int right)
{
    if(right-left <= 0)           // if size is 1,
        return;                   // it's already sorted
    else                           // size is 2 or larger
    {
        // partition range
        int partition = partitionIt(left, right);
        recQuickSort(left, partition-1); // sort left side
        recQuickSort(partition+1, right); // sort right side
    }
}
```

As you can see, there are three basic steps:

1. Partition the array or subarray into left (smaller keys) and right (larger keys) groups.
2. Call ourselves to sort the left group.
3. Call ourselves again to sort the right group.

After a partition, all the items in the left subarray are smaller than all those on the right. If we then sort the left subarray and sort the right subarray, the entire array will be sorted. How do we sort these subarrays? By calling ourself.

The arguments to the `recQuickSort()` method determine the left and right ends of the array (or subarray) it's supposed to sort. The method first checks whether this array consists of only one element. If so, the array is by definition already sorted, and the method returns immediately. This is the base case in the recursion process.

If the array has two or more cells, the algorithm calls the `partitionIt()` method, described in the last section, to **partition** it. This method returns the index number of the *partition*: the left element in the right (larger keys) subarray. The partition marks the boundary between the subarrays. This is shown in Figure 7.8.

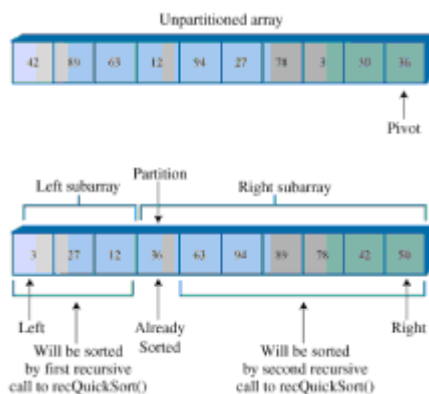

Figure 7.8: Recursive calls sort subarrays

Once the array is partitioned, `recQuickSort()` calls itself recursively, once for the left part of its array, from `left` to `partition-1`, and once for the right part, from `partition+1` to `right`. Note that the data item at the index `partition` is not included in either of the recursive calls. Why not? Doesn't it need to be sorted? The explanation lies in how the pivot value is chosen.

Choosing a Pivot Value

What pivot value should the `partitionIt()` method use? Here are some relevant ideas:

- The pivot value should be the key value of an actual data item; this item is called the *pivot*.
- You can pick a data item to be the pivot more or less at random. For simplicity, let's say we always pick the item on the right end of the subarray being partitioned.
- After the partition, if the pivot is inserted at the boundary between the left and right subarrays, it will be in its final sorted position.

This last point may sound unlikely, but remember that, because the pivot's key value is used to partition the array, then following the partition the left subarray holds items smaller than the pivot, and the right subarray holds items larger. The pivot starts out on the right, but if it could somehow be placed between these two subarrays, it would be in the right place; that is, in its final sorted position. Figure 7.9 shows how this looks with a pivot whose key value is 36.

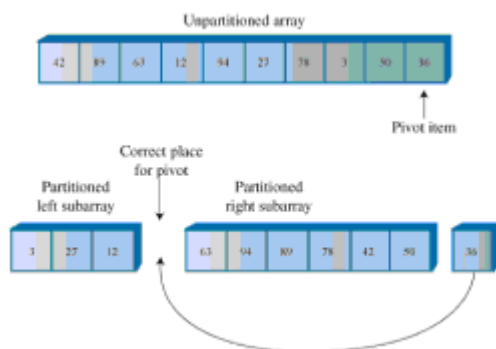

Figure 7.9: The pivot and the subarrays

This figure is somewhat fanciful because you can't actually take an array apart as we've shown. So how do we move the pivot to its proper place?

We could shift all the items in the right subarray to the right one cell to make room for the pivot. However, this is inefficient and unnecessary. Remember that all the items in the right subarray, although they are larger than the pivot, are not yet sorted, so they can be moved around within the right subarray without affecting anything.

Therefore, to simplify inserting the pivot in its proper place, we can simply swap the pivot (36) and the left item in the right subarray, which is 63. This places the pivot in its proper position between the left and right groups. The 63 is switched to the right end, but because it remains in the right (larger) group, the partitioning is undisturbed. This is shown in Figure 7.10.



Figure 7.10: Swapping the pivot

Once it's swapped into the partition's location, the pivot is in its final resting place. All subsequent activity will take place on one side of it or on the other, but the pivot itself won't be moved (or indeed even accessed) again.

To incorporate the pivot selection process into our `recQuickSort()` method, let's make it an overt statement, and send the pivot value to `partitionIt()` as an argument. Here's how that looks:

```
public void recQuickSort(int left, int right)
{
    if(right-left <= 0)           // if size <= 1,
        return;                  // already sorted
    else                          // size is 2 or larger
    {
        double pivot = theArray[right]; // rightmost item
                                        // partition range
        int partition = partitionIt(left, right, pivot);
        recQuickSort(left, partition-1); // sort left side
        recQuickSort(partition+1, right); // sort right side
    }

} // end recQuickSort()
```

When we use this scheme of choosing the rightmost item in the array as the pivot, we'll need to modify the `partitionIt()` method to exclude this rightmost item from the partitioning process; after all, we already know where it should go after the partitioning process is complete: at the partition, between the two groups. Also, once the partitioning process is completed, we need to swap the pivot from the right end into the partition's location. Listing 7.3 shows the `quickSort1.java` program, which incorporates these features.

Listing 7.3 The quickSort1.java Program

```
// quickSort1.java

// demonstrates simple version of quick sort

// to run this program: C>java QuickSort1App

////////////////////////////////////
```

```

class ArrayIns
{
    private double[] theArray;        // ref to array theArray
    private int nElems;               // number of data items

//-----
-
    public ArrayIns(int max)          // constructor
    {
        theArray = new double[max];  // create the array
        nElems = 0;                  // no items yet
    }

//-----
-
    public void insert(double value)  // put element into array
    {
        theArray[nElems] = value;    // insert it
        nElems++;                    // increment size
    }

//-----
-
    public void display()             // displays array contents
    {
        System.out.print("A=");
        for(int j=0; j<nElems; j++)   // for each element,
            System.out.print(theArray[j] + " "); // display it
        System.out.println("");
    }

//-----
-
    public void quickSort()
    {
        recQuickSort(0, nElems-1);
    }

//-----
-
    public void recQuickSort(int left, int right)
    {
        if(right-left <= 0)          // if size <= 1,
            return;                  // already sorted
        else                          // size is 2 or larger
        {
            double pivot = theArray[right]; // rightmost item
                                           // partition range
            int partition = partitionIt(left, right, pivot);
            recQuickSort(left, partition-1); // sort left side
            recQuickSort(partition+1, right); // sort right side
        }
    } // end recQuickSort()
}

```

```

//-----
-
    public int partitionIt(int left, int right, double pivot)
    {
        int leftPtr = left-1;           // left    (after ++)
        int rightPtr = right;           // right-1 (after --)
        while(true)
        {
            // find bigger item
            while(theArray[++leftPtr] < pivot)
                ; // (nop)

            // find smaller item
            while(rightPtr > 0 && theArray[--rightPtr] > pivot)
                ; // (nop)

            if(leftPtr >= rightPtr)      // if pointers cross,
                break;                  // partition done
            else                          // not crossed, so
                swap(leftPtr, rightPtr); // swap elements
        } // end while(true)
        swap(leftPtr, right);           // restore pivot
        return leftPtr;                 // return pivot location
    } // end partitionIt()

//-----
-
    public void swap(int dex1, int dex2) // swap two elements
    {
        double temp = theArray[dex1];  // A into temp
        theArray[dex1] = theArray[dex2]; // B into A
        theArray[dex2] = temp;         // temp into B
    } // end swap()

//-----
-
    } // end class ArrayIns

////////////////////////////////////

class QuickSort1App
{
    public static void main(String[] args)
    {
        int maxSize = 16;                // array size
        ArrayIns arr;
        arr = new ArrayIns(maxSize);     // create array

        for(int j=0; j<maxSize; j++)    // fill array with
        {
            // random numbers
            double n = (int)(java.lang.Math.random()*99);
            arr.insert(n);
        }
        arr.display();                   // display items
        arr.quickSort();                 // quicksort them
    }
}

```

```

arr.display();                // display them again
} // end main()

} // end class QuickSort1App

```

The `main()` routine creates an object of type `ArrayIns`, inserts 16 random data items of type `double` in it, displays it, sorts it with the `quickSort()` method, and displays the results. Here's some typical output:

```

A=69 0 70 6 38 38 24 56 44 26 73 77 30 45 97 65
A=0 6 24 26 30 38 38 44 45 56 65 69 70 73 77 97

```

An interesting aspect of the code in the `partitionIt()` method is that we've been able to remove the test for the end of the array in the first inner `while` loop. This test, seen in the earlier `partitionIt()` method in the `partition.java` program in Listing 7.2, was

```

leftPtr < right

```

It prevented `leftPtr` running off the right end of the array if there was no item there larger than `pivot`. Why can we eliminate the test? Because we selected the rightmost item as the pivot, so `leftPtr` will always stop there. However, the test is still necessary for `rightPtr` in the second `while` loop. (Later we'll see how this test can be eliminated as well.)

Choosing the rightmost item as the pivot is thus not an entirely arbitrary choice; it speeds up the code by removing an unnecessary test. Picking the pivot from some other location would not provide this advantage.

The quickSort1 Workshop Applet

At this point you know enough about the quicksort algorithm to understand the nuances of the quickSort1 Workshop applet.

The Big Picture

For the big picture, use the Size button to set the applet to sort 100 random bars, and press the Run button. Following the sorting process, the display will look something like Figure 7.11.

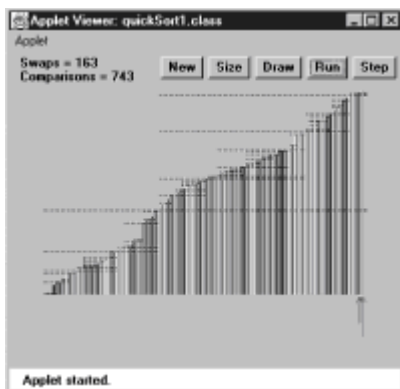

Figure 7.11: The quickSort1 Workshop applet with 100 bars

Watch how the algorithm partitions the array into two parts, then sorts each of these parts by partitioning it into two parts, and so on, creating smaller and smaller subarrays.

When the sorting process is complete, each dotted line provides a visual record of one of the sorted subarrays. The horizontal range of the line shows which bars were part of the subarray, and its vertical position is the pivot value (the height of the pivot). The total length of all these lines on the display is a measure of how much work the algorithm has done to sort the array; we'll return to this topic later.

Each dotted line (except the shortest ones) should have a line below it (probably separated by other, shorter lines) and a line above it that together add up to the same length as the original line (less one bar). These are the two partitions into which each subarray is divided.

The Details

For a more detailed examination of quicksort's operation, switch to the quickSort1 applet and step through the sorting process. You'll see how the pivot value corresponds to the height of the pivot on the right side of the array, how the algorithm partitions the array, swaps the pivot into the space between the two sorted groups, sorts the shorter group (using many recursive calls), and then sorts the larger group.

Figure 7.12 shows all the steps involved in sorting 12 bars. The horizontal brackets under the arrays show which subarray is being partitioned at each step, and the circled numbers show the order in which these partitions are created. A pivot being swapped into place is shown with a dotted arrow. The final position of the pivot is shown as a dotted cell to emphasize that this cell contains a sorted item that will not be changed thereafter. Horizontal brackets under single cells (steps 5, 6, 7, 11, and 12) are base case calls to `recQuickSort()`; they return immediately.

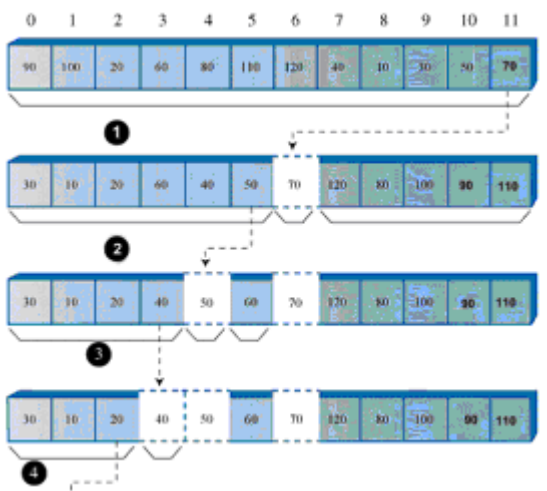

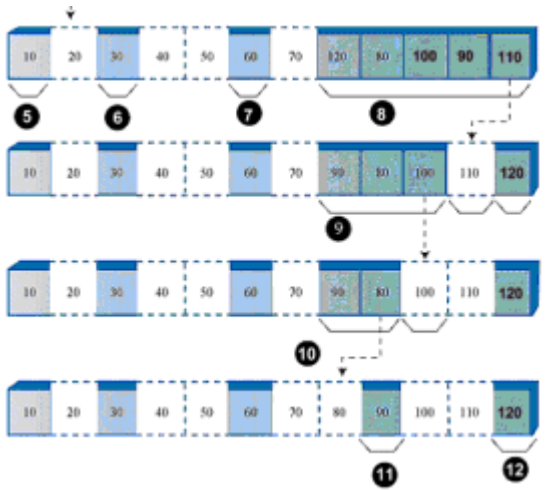

Figure 7.12: The quicksort process

Sometimes, as in steps 4 and 10, the pivot ends up in its original position on the right side of the array being sorted. In this situation, there is only one subarray remaining to be sorted; that to the left of the pivot. There is no second subarray to its right.

The different steps in Figure 7.12 occur at different levels of recursion, as shown in Table 7.3. The initial call from `main()` to `recQuickSort()` is the first level, `recQuickSort()` calling two new instances of itself is the second level, these two instances calling four more instances is the third level, and so on.

The order in which the partitions are created, corresponding to the step numbers, does not correspond with depth. It's not the case that all the first-level partitions are done first, then all the second level ones, and so on. Instead, the left group at every level is handled before any of the right groups.

Table 7.3: Recursion levels for Figure 7.12

Step	Recursion Level
1	1
2, 8	2
3, 7, 9, 12	3
4, 10	4
5, 6, 11	5

In theory there should be eight steps in the fourth level and 16 in the fifth level, but in this small array we run out of items before these steps are necessary.

The number of levels in the table shows that with 12 data items, the machine stack needs enough space for 5 sets of arguments and return values; one for each recursion level. This is, as we'll see later, somewhat greater than the logarithm to the base 2 of the number of items: $\log_2 N$. The size of the machine stack is determined by your particular system. Sorting very large numbers of data items using recursive procedures may cause this stack to overflow, leading to memory errors.

Things to Notice

Here are some details you may notice as you run the quickSort1 Workshop applet.

You might think that a powerful algorithm like quicksort would not be able to handle subarrays as small as 2 or 3 items. However, this version of the quicksort algorithm is quite capable of sorting such small subarrays; `leftScan` and `rightScan` just don't go very far before they meet. For this reason we don't need to use a different sorting scheme for small subarrays. (Although, as we'll see later, handling small subarrays differently may have advantages.)

At the end of each scan, the `leftScan` variable ends up pointing to the partition—that is, the left element of the right subarray. The pivot is then swapped with the partition to put the pivot in its proper place, as we've seen. As we noted, in steps 3 and 9 of [Figure 7.12](#), `leftScan` ends up pointing to the pivot itself, so the swap has no effect. This may seem like a wasted swap; you might decide that `leftScan` should stop one bar sooner. However, it's important that `leftScan` scan all the way to the pivot; otherwise, a swap would unsort the pivot and the partition.

Be aware that `leftScan` and `rightScan` start at `left-1` and `right`. This may look peculiar on the display, especially if `left` is 0; then `leftScan` will start at `-1`. Similarly `rightScan` initially points to the pivot, which is not included in the partitioning process. These pointers start outside the subarray being partitioned, because they will be incremented and decremented respectively before they're used the first time.

The applet shows ranges as numbers in parentheses; for example, `(2-5)` means the subarray from index 2 to index 5. The range given in some of the messages may be negative: from a higher number to a lower one: `Array partitioned; left (7-6), right (8-8)`, for example. The `(8-8)` range means a single cell (8), but what does `(7-6)` mean? This range isn't real; it simply reflects the values that `left` and `right`, the arguments to `recQuickSort()`, have when this method is called. Here's the code in question:

```
int partition = partitionIt(left, right, pivot);
recQuickSort(left, partition-1); // sort left side
recQuickSort(partition+1, right); // sort right side
```

If `partitionIt()` is called with `left = 7` and `right = 8`, for example, and happens to return 7 as the partition, then the range supplied in the first call to `recQuickSort()` will be `(7-6)` and the range to the second will be `(8-8)`. This is normal. The base case in `recQuickSort()` is activated by array sizes less than 1 as well as by 1, so it will return immediately for negative ranges. Negative ranges are not shown in [Figure 7.12](#), although they do cause (brief) calls to `recQuickSort()`.

Degenerates to $O(N^2)$ Performance

If you use the quickSort1 Workshop applet to sort 100 inversely sorted bars, you'll see that the algorithm runs much more slowly and that many more dotted horizontal lines are generated, indicating more and larger subarrays are being partitioned. What's happening here?

The problem is in the selection of the pivot. Ideally, the pivot should be the median of the items being sorted. That is, half the items should be larger than the pivot, and half smaller. This would result in the array being partitioned into two subarrays of equal size. Two equal subarrays is the optimum situation for the quicksort algorithm. If it has to sort one large and one small array, it's less efficient because the larger subarray has to be subdivided more times.

The worst situation results when a subarray with N elements is divided into one subarray with 1 element and the other with $N-1$ elements. (This division into 1 cell and $N-1$ cells can also be seen in steps 3 and 9 in [Figure 7.12](#).) If this 1 and $N-1$ division happens with every partition, then every element requires a separate partition step. This is in fact what takes place with inversely sorted data: in all the subarrays, the pivot is the smallest item, so every partition results in an $N-1$ element in one subarray and only the pivot in the other.

To see this unfortunate process in action, step through the quickSort1 Workshop applet with 12 inversely sorted bars. Notice how many more steps are necessary than with random data. In this situation the advantage gained by the partitioning process is lost and the performance of the algorithm degenerates to $O(N^2)$.

Besides being slow, there's another potential problem when quicksort operates in $O(N^2)$ time. When the number of partitions increases, the number of recursive function calls also increases. Every function call takes up room on the machine stack. If there are too many calls, the machine stack may overflow and paralyze the system.

To summarize: In the quickSort1 applet, we select the rightmost element as the pivot. If the data is truly random, this isn't too bad a choice, because usually the pivot won't be too close to either end of the array. However, when the data is sorted or inversely sorted, choosing the pivot from one end or the other is a bad idea. Can we improve on our approach to selecting the pivot?

Median of Three Partitioning

Many schemes have been devised for picking a better pivot. The method should be simple but have a good chance of avoiding the largest or smallest value. Picking an element at random is simple but—as we've seen—doesn't always result in a good selection. However, we could examine all the elements and actually calculate which one was the median. This would be the ideal pivot choice, but the process isn't practical, as it would take more time than the sort itself.

A compromise solution is to find the median of the first, last, and middle elements of the array, and use this for the pivot. (The *median* or *middle* item is the data item chosen so that exactly half the other items are smaller and half are larger.) Picking the median of the first, last, and middle elements is called the *median-of-three* approach and is shown in [Figure 7.13](#).

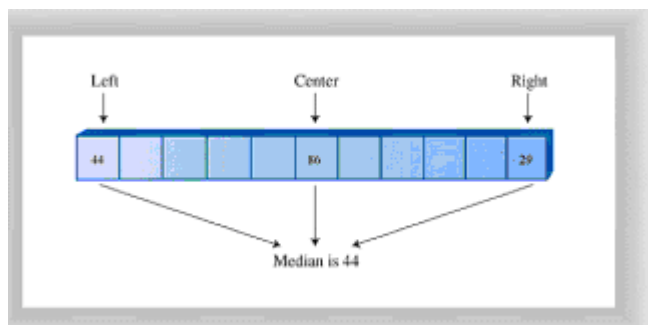

Figure 7.13: The median of three

Finding the median of three items is obviously much faster than finding the median of all the items, and yet it successfully avoids picking the largest or smallest item in cases where the data is already sorted or inversely sorted. There are probably some pathological arrangements of data where the median-of-three scheme works poorly, but normally it's a fast and effective technique for finding the pivot.

Besides picking the pivot more effectively, the median of three approach has an additional benefit: We can dispense with the `rightPtr > left` test in the second inside `while` loop, leading to a small increase in the algorithm's speed. How is this possible?

The test can be eliminated because we can use the median-of-three approach to not only select the pivot, but also to sort the three elements used in the selection process. Figure 7.14 shows how this looks.

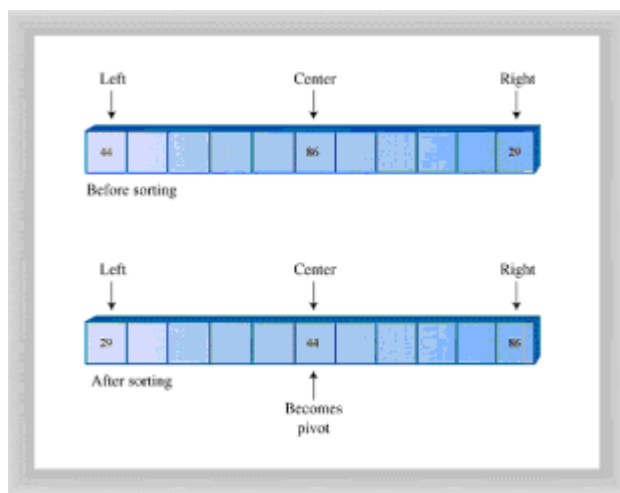

Figure 7.14: Sorting the left, center, and right elements

Once these three elements are sorted, and the median item is selected as the pivot, we are guaranteed that the element at the left end of the subarray is less than (or equal to) the pivot, and the element at the right end is greater than (or equal to) the pivot. This means that the `leftPtr` and `rightPtr` indices can't step beyond the right or left ends of the array, respectively, even if we remove the `leftPtr > right` and `rightPtr < left` tests. (The pointer will stop, thinking it needs to swap the item, only to find that it has crossed the other pointer and the partition is complete.) The values at `left` and `right` act as *sentinels* to keep `leftPtr` and `rightPtr` confined to valid array values.

Another small benefit to median-of-three partitioning is that after the left, center, and right elements are sorted, the partition process doesn't need to examine these elements again. The partition can begin at `left+1` and `right-1`, because `left` and `right` have in effect already been partitioned. We know that `left` is in the correct partition because it's on the left and it's less than the pivot, and `right` is in the correct place because it's on the right and it's greater than the pivot.

Thus, median-of-three partitioning not only avoids $O(N^2)$ performance for already sorted data, it also allows us to speed up the inner loops of the partitioning algorithm and reduce slightly the number of items that must be partitioned.

The `quickSort2.java` Program

Listing 7.4 shows the `quickSort2.java` program, which incorporates median-of-three partitioning. We use a separate method, `medianOf3()`, to sort the left, center, and right

elements of a subarray. This method returns the value of the pivot, which is then sent to the `partitionIt()` method.

Listing 7.4 The `quickSort2.java` Program

```
// quickSort2.java
// demonstrates quick sort with median-of-three partitioning
// to run this program: C>java QuickSort2App
////////////////////////////////////////////////////////////////////////////////////////////////////////////////////////////////
class ArrayIns
{
    private double[] theArray;        // ref to array theArray
    private int nElems;              // number of data items

//-----
-
    public ArrayIns(int max)          // constructor
    {
        theArray = new double[max];  // create the array
        nElems = 0;                  // no items yet
    }

//-----
-
    public void insert(double value)  // put element into array
    {
        theArray[nElems] = value;    // insert it
        nElems++;                    // increment size
    }

//-----
-
    public void display()             // displays array contents
    {
        System.out.print("A=");
        for(int j=0; j<nElems; j++)  // for each element,
            System.out.print(theArray[j] + " "); // display it
        System.out.println("");
    }

//-----
-
    public void quickSort()
    {
        recQuickSort(0, nElems-1);
    }

//-----
-
    public void recQuickSort(int left, int right)
    {
        int size = right-left+1;
        if(size <= 3)                // manual sort if small
            manualSort(left, right);
    }
}
```

```

else // quicksort if large
{
double median = medianOf3(left, right);
int partition = partitionIt(left, right, median);
recQuickSort(left, partition-1);
recQuickSort(partition+1, right);
}
} // end recQuickSort()

//-----
-
public double medianOf3(int left, int right)
{
int center = (left+right)/2;
// order left & center
if( theArray[left] > theArray[center] )
swap(left, center);
// order left & right
if( theArray[left] > theArray[right] )
swap(left, right);
// order center & right
if( theArray[center] > theArray[right] )
swap(center, right);

swap(center, right-1); // put pivot on right
return theArray[right-1]; // return median value
} // end medianOf3()

//-----
-
public void swap(int dex1, int dex2) // swap two elements
{
double temp = theArray[dex1]; // A into temp
theArray[dex1] = theArray[dex2]; // B into A
theArray[dex2] = temp; // temp into B
} // end swap()

//-----
-
public int partitionIt(int left, int right, double pivot)
{
int leftPtr = left; // right of first elem
int rightPtr = right - 1; // left of pivot

while(true)
{
while(theArray[++leftPtr] < pivot) // find bigger
; // (nop)
while(theArray[--rightPtr] > pivot) // find smaller
; // (nop)
if(leftPtr >= rightPtr) // if pointers cross,
break; // partition done
else // not crossed, so

```

```

        swap(leftPtr, rightPtr); // swap elements
    } // end while(true)
    swap(leftPtr, right-1);      // restore pivot
/***/
    return leftPtr;             // return pivot location
} // end partitionIt()

//-----
-
public void manualSort(int left, int right)
{
    int size = right-left+1;
    if(size <= 1)
        return; // no sort necessary
    if(size == 2)
    {
        // 2-sort left and right
        if( theArray[left] > theArray[right] )
            swap(left, right);
        return;
    }
    else // size is 3
    {
        // 3-sort left, center (right-1) &
right
        if( theArray[left] > theArray[right-1] )
            swap(left, right-1); // left, center
        if( theArray[left] > theArray[right] )
            swap(left, right); // left, right
        if( theArray[right-1] > theArray[right] )
right
            swap(right-1, right); // center,
    }
} // end manualSort()

//-----
-
} // end class ArrayIns

////////////////////////////////////

class QuickSort2App
{
    public static void main(String[] args)
    {
        int maxSize = 16; // array size
        ArrayIns arr; // reference to array
        arr = new ArrayIns(maxSize); // create the array

        for(int j=0; j<maxSize; j++) // fill array with
        { // random numbers
            double n = (int)(java.lang.Math.random()*99);
            arr.insert(n);
        }
        arr.display(); // display items
        arr.quickSort(); // quicksort them
    }
}

```

```

arr.display();           // display them again
} // end main()

} // end class QuickSort2App

```

This program uses another new method, `manualSort()`, to sort subarrays of 3 or fewer elements. It returns immediately if the subarray is 1 cell (or less), swaps the cells if necessary if the range is 2, and sorts 3 cells if the range is 3. The `recQuickSort()` routine can't be used to sort ranges of 2 or 3 because median partitioning requires at least 4 cells.

The `main()` routine and the output of `quickSort2.java` are similar to those of `quickSort1.java`.

The quickSort2 Workshop Applet

The `quickSort2` Workshop applet demonstrates the quicksort algorithm using median-of-three partitioning. This applet is similar to the `quickSort1` Workshop applet, but starts off sorting the first, center, and left elements of each subarray and selecting the median of these as the pivot value. At least, it does this if the array size is greater than 3. If the subarray is 2 or 3 units, the applet simply sorts it "by hand" without partitioning or recursive calls.

Notice the dramatic improvement in performance when the applet is used to sort 100 inversely ordered bars. No longer is every subarray partitioned into 1 cell and $N-1$ cells; instead, the subarrays are partitioned roughly in half.

Other than this improvement for ordered data, the `quickSort2` Workshop applet produces results similar to `quickSort1`. It is no faster when sorting random data; its advantages become evident only when sorting ordered data.

Handling Small Partitions

If you use the median-of-three partitioning method, it follows that the quicksort algorithm won't work for partitions of three or fewer items. The number 3 in this case is called a *cutoff* point. In the previous examples we sorted subarrays of 2 or 3 items by hand. Is this the best way?

Using an Insertion Sort for Small Partitions

Another option for dealing with small partitions is to use the insertion sort. When you do this, you aren't restricted to a cutoff of 3. You can set the cutoff to 10, 20, or any other number. It's interesting to experiment with different values of the cutoff to see where the best performance lies. Knuth (see the bibliography) recommends a cutoff of 9. However, the optimum number depends on your computer, operating system, compiler (or interpreter), and so on.

The `quickSort3.java` program, shown in Listing 7.5, uses an insertion sort to handle subarrays of fewer than 10 cells.

Listing 7.5 The quickSort3.java Program

```

// quickSort3.java
// demonstrates quick sort; uses insertion sort for cleanup
// to run this program: C>java QuickSort3App
////////////////////////////////////
class ArrayIns

```



```

    {
    private double[] theArray;           // ref to array theArray
    private int nElems;                 // number of data items

//-----
-
    public ArrayIns(int max)           // constructor
    {
        theArray = new double[max];    // create the array
        nElems = 0;                   // no items yet
    }

//-----
-
    public void insert(double value)   // put element into array
    {
        theArray[nElems] = value;      // insert it
        nElems++;                      // increment size
    }

//-----
-
    public void display()              // displays array contents
    {
        System.out.print("A=");
        for(int j=0; j<nElems; j++)    // for each element,
            System.out.print(theArray[j] + " "); // display it
        System.out.println("");
    }

//-----
-
    public void quickSort()
    {
        recQuickSort(0, nElems-1);
        insertionSort(0, nElems-1);
    }

//-----
-
    public void recQuickSort(int left, int right)
    {
        int size = right-left+1;
        if(size < 10)                 // insertion sort if
small
            insertionSort(left, right);
        else                           // quicksort if large
        {
            double median = medianOf3(left, right);
            int partition = partitionIt(left, right, median);
            recQuickSort(left, partition-1);
            recQuickSort(partition+1, right);
        }
    } // end recQuickSort()

```

```

//-----
-
public double medianOf3(int left, int right)
{
    int center = (left+right)/2;
                                // order left & center
    if( theArray[left] > theArray[center] )
        swap(left, center);
                                // order left & right
    if( theArray[left] > theArray[right] )
        swap(left, right);
                                // order center & right
    if( theArray[center] > theArray[right] )
        swap(center, right);

    swap(center, right-1);      // put pivot on right
    return theArray[right-1];  // return median value
} // end medianOf3()

//-----
-
public void swap(int dex1, int dex2) // swap two elements
{
    double temp = theArray[dex1]; // A into temp
    theArray[dex1] = theArray[dex2]; // B into A
    theArray[dex2] = temp; // temp into B
} // end swap()

//-----
-
public int partitionIt(int left, int right, double pivot)
{
    int leftPtr = left; // right of first elem
    int rightPtr = right - 1; // left of pivot
    while(true)
    {
        while( theArray[++leftPtr] < pivot ) // find bigger
            ; // (nop)
        while( theArray[--rightPtr] > pivot ) // find smaller
            ; // (nop)
        if(leftPtr >= rightPtr) // if pointers cross,
            break; // partition done
        else // not crossed, so
            swap(leftPtr, rightPtr); // swap elements
    } // end while(true)
    swap(leftPtr, right-1); // restore pivot
    return leftPtr; // return pivot location
} // end partitionIt()

//-----
-
                                // insertion sort
public void insertionSort(int left, int right)

```

```

    {
    int in, out;
                                // sorted on left of
out    for(out=left+1; out<=right; out++)
        {
            double temp = theArray[out]; // remove marked item
            in = out; // start shifts at out
                                // until one is smaller,
            while(in>left && theArray[in-1] >= temp)
                {
right    theArray[in] = theArray[in-1]; // shift item to
            --in; // go left one position
                }
            theArray[in] = temp; // insert marked item
        } // end for
    } // end insertionSort()

//-----
-
    } // end class ArrayIns

////////////////////////////////////

class QuickSort3App
{
    public static void main(String[] args)
    {
        int maxSize = 16; // array size
        ArrayIns arr; // reference to array
        arr = new ArrayIns(maxSize); // create the array

        for(int j=0; j<maxSize; j++) // fill array with
            { // random numbers
                double n = (int)(java.lang.Math.random()*99);
                arr.insert(n);
            }
        arr.display(); // display items
        arr.quickSort(); // quicksort them
        arr.display(); // display them again
    } // end main()

} // end class QuickSort3App

```

Using the insertion sort for small subarrays turns out to be the fastest approach on our particular installation, but it is not much faster than sorting subarrays of 3 or fewer cells by hand, as in `quickSort2.java`. The numbers of comparisons and copies are reduced substantially in the quicksort phase, but are increased by an almost equal amount in the insertion sort, so the time savings are not dramatic. However, it's probably a worthwhile approach if you are trying to squeeze the last ounce of performance out of quicksort.

Insertion Sort Following Quicksort

Another option is to completely quicksort the array without bothering to sort partitions smaller than the cutoff. When quicksort is finished, the array will be almost sorted. You then apply the insertion sort to the entire array. The insertion sort is supposed to operate efficiently on almost-sorted arrays, and this approach is recommended by some experts, but on our installation it runs very slowly. The insertion sort appears to be happier doing a lot of small sorts than one big one.

Removing Recursion

Another embellishment recommended by many writers is removing recursion from the quicksort algorithm. This involves rewriting the algorithm to store deferred subarray bounds (`left` and `right`) on a stack, and using a loop instead of recursion to oversee the partitioning of smaller and smaller subarrays. The idea in doing this is to speed up the program by removing method calls. However, this idea arose with older compilers and computer architectures, which imposed a large time penalty for each method call. It's not clear that removing recursion is much of an improvement for modern systems, which handle method calls more efficiently.

Efficiency of Quicksort

We've said that quicksort operates in $O(N \cdot \log N)$ time. As we saw in the discussion of mergesort in [Chapter 6](#), this is generally true of the divide-and-conquer algorithms, in which a recursive method divides a range of items into two groups and then calls itself to handle each group. In this situation the logarithm actually has a base of 2: the running time is proportional to $N \cdot \log_2 N$.

You can get an idea of the validity of this $N \cdot \log_2 N$ running time for quicksort by running one of the quickSort Workshop applets with 100 random bars and examining the resulting dotted horizontal lines.

Each dotted line represents an array or subarray being partitioned: the pointers `leftScan` and `rightScan` moving toward each other, comparing each data item and swapping when appropriate. We saw in the section on [partitioning](#) that a single partition runs in $O(N)$ time. This tells us that the total length of all the lines is proportional to the running time of quicksort. But how long are all the lines? It would be tedious to measure them with a ruler on the screen, but we can visualize them a different way.

There is always one line that runs the entire width of the graph, spanning N bars. This results from the first partition. There will also be two lines (one below and one above the first line) that have an average length of $N/2$ bars; together they are again N bars long. Then there will be four lines with an average length of $N/4$ that again total N bars, then 8 lines, 16, and so on. Figure 7.15 shows how this looks for 1, 2, 4, and 8 lines.

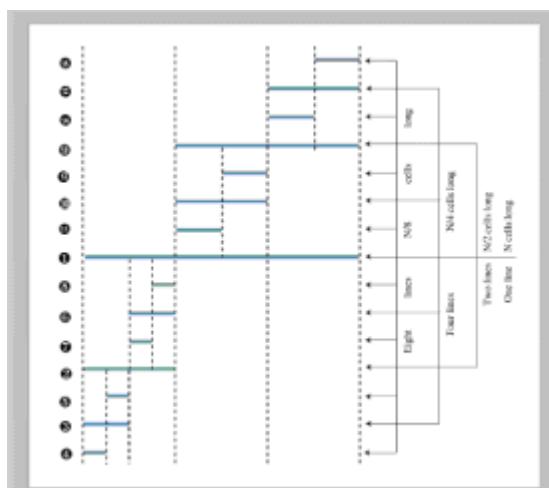

Figure 7.15: Lines correspond to partitions

In this figure solid horizontal lines represent the dotted horizontal lines in the quicksort applets, and captions like *N/4 cells long* indicate average, not actual, line lengths. The circled numbers on the left show the order in which the lines are created.

Each series of lines (the eight N/8 lines, for example) corresponds to a level of recursion. The initial call to `recQuickSort()` is the first level and makes the first line; the two calls from within the first call—the second level of recursion—make the next two lines; and so on. If we assume we start with 100 cells, the results are shown in Table 7.4.

Table 7.4: Line Lengths and Recursion

Recursion level	Step Numbers in Figure 7.15	Average Line Length (Cells)	Number of Lines	Total Length (Cells)
1	1	100	1	100
2	2, 9	50	2	100
3	3, 6, 10, 13	25	4	100
4	4, 5, 7, 8, 11, 12, 14, 15	12	8	96
5	Not shown	6	16	96
6	Not shown	3	32	96
7	Not shown	1	64	64
				Total = 652

Where does this division process stop? If we keep dividing 100 by 2, and count how many times we do this, we get the series 100, 50, 25, 12, 6, 3, 1, which is 7 levels of recursion. This looks about right on the workshop applets: if you pick some point on the graph and count all the dotted lines directly above and below it, there will be an average of approximately 7. (In [Figure 7.15](#), because not all levels of recursion are shown, only 4 lines intersect any vertical slice of the graph.)

Table 7.4 shows a total of 652 cells. This is only an approximation because of round-off errors, but it's close to 100 times the logarithm to the base 2 of 100, which is 6.65. Thus this informal analysis suggests the validity of the $N \cdot \log_2 N$ running time for quicksort.

More specifically, in the section on [partitioning](#), we found that there should be $N+2$ comparisons and fewer than $N/2$ swaps. Multiplying these quantities by $\log_2 N$ for various values of N gives the results shown in Table 7.5.

Table 7.5: Swaps and Comparisons in Quicksort

N	8	12	16	64	100	128
$\log_2 N$	3	3.59	4	6	6.65	7
$N \cdot \log_2 N$	24	43	64	384	665	896
Comparisons: $(N+2) \cdot \log_2 N$	30	50	72	396	678	910
Swaps: fewer than $N/2 \cdot \log_2 N$	12	21	32	192	332	448

The $\log_2 N$ quantity used in Table 7.5 is actually true only in the best-case scenario, where each subarray is partitioned exactly in half. For random data the figure is slightly greater. Nevertheless, the quickSort1 and quickSort2 Workshop applets approximate these results for 12 and 100 bars, as you can see by running them and observing the Swaps and Comparisons fields.

Because they have different cutoff points and handle the resulting small partitions differently, quickSort1 performs fewer swaps but more comparisons than quickSort2. The number of swaps shown in the table is the maximum (which assumes the data is inversely sorted). For random data the actual number of swaps turns out to be half to two thirds of the figures shown.

Summary

- The Shellsort applies the insertion sort to widely spaced elements, then less widely spaced elements, and so on.
- The expression *n-sorting* means sorting every *n*th element.
- A sequence of numbers, called the *interval sequence*, or *gap sequence*, is used to determine the sorting intervals in the Shellsort.
- A widely used interval sequence is generated by the recursive expression $h=3 \cdot h+1$, where the initial value of *h* is 1.
- If an array holds 1,000 items, it could be 364-sorted, 121-sorted, 40-sorted, 13-sorted, 4-sorted, and finally 1-sorted.
- The Shellsort is hard to analyze, but runs in approximately $O(N \cdot (\log N)^2)$ time. This is much faster than the $O(N^2)$ algorithms like insertion sort, but slower than the $O(N \cdot \log N)$ algorithms like quicksort.
- To *partition* an array is to divide it into two subarrays, one of which holds items with key values less than a specified value, while the other holds items with keys greater or equal to this value.
- The *pivot value* is the value that determines into which group an item will go during partitioning; items smaller than the pivot value go in the left group, larger items go in

the right group.

- In the partitioning algorithm, two array indices, each in its own `while` loop, start at opposite ends of the array and step toward each other, looking for items that need to be swapped.
- When an index finds an item that needs to be swapped, its `while` loop exits.
- When both `while` loops exit, the items are swapped.
- When both `while` loops exit and the indices have met or passed each other, the partition is complete.
- Partitioning operates in linear $O(N)$ time, making N plus 1 or 2 comparisons and fewer than $N/2$ swaps.
- The partitioning algorithm may require extra tests in its inner `while` loops to prevent the indices running off the ends of the array.
- Quicksort partitions an array and then calls itself twice recursively to sort the two resulting subarrays.
- Subarrays of one element are already sorted; this can be a base case for quicksort.
- The pivot value for a partition in quicksort is the key value of a specific item, called the pivot.
- In a simple version of quicksort, the pivot can always be the item at the right end of the subarray.
- During the partition the pivot is placed out of the way on the right, and is not involved in the partitioning process.
- Later the pivot is swapped again, into the space between the two partitions. This is its final sorted position.
- In the simple version of quicksort, performance is only $O(N^2)$ for already sorted (or inversely sorted) data.
- In a more advanced version of quicksort, the pivot can be the median of the first, last, and center items in the subarray. This is called *median-of-three* partitioning.
- Median-of-three partitioning effectively eliminates the problem of $O(N^2)$ performance for already sorted data.
- In median-of-three partitioning, the left, center, and right items are sorted at the same time the median is determined.
- This sort eliminates the need for the end-of-array tests in the inner `while` loops in the partitioning algorithm.
- Quicksort operates in $O(N \log_2 N)$ time (except when the simpler version is applied to already sorted data).
- Subarrays smaller than a certain size (the *cutoff*) can be sorted by a method other than quicksort.

- The insertion sort is commonly used to sort subarrays smaller than the cutoff.
- The insertion sort can also be applied to the entire array, after it has been sorted down to a cutoff point by quicksort.

Chapter 8: Binary Trees

Overview

In this chapter we switch from algorithms, the focus of the [last chapter](#) on sorting, to data structures. Binary trees are one of the fundamental data storage structures used in programming. They provide advantages that the data structures we've seen so far cannot. In this chapter we'll learn why you would want to use trees, how they work, and how to go about creating them.

Why Use Binary Trees?

Why might you want to use a tree? Usually, because it combines the advantages of two other structures: an ordered array and a linked list. You can search a tree quickly, as you can an ordered array, and you can also insert and delete items quickly, as you can with a linked list. Let's explore these topics a bit before delving into the details of trees.

Slow Insertion in an Ordered Array

Imagine an array in which all the elements are arranged in order; that is, an ordered array, such as we saw in [Chapter 3, "Simple Sorting."](#) As we learned, it's quick to search such an array for a particular value, using a binary search. You check in the center of the array; if the object you're looking for is greater than what you find there, you narrow your search to the top half of the array; if it's less, you narrow your search to the bottom half. Applying this process repeatedly finds the object in $O(\log N)$ time. It's also quick to iterate through an ordered array, visiting each object in sorted order.

On the other hand, if you want to insert a new object into an ordered array, you first need to find where the object will go, and then move all the objects with greater keys up one space in the array to make room for it. These multiple moves are time consuming, requiring, on the average, moving half the items ($N/2$ moves). Deletion involves the same multimove operation, and is thus equally slow.

If you're going to be doing a lot of insertions and deletions, an ordered array is a bad choice.

Slow Searching in a Linked List

On the other hand, as we saw in [Chapter 7, "Advanced Sorting,"](#) insertions and deletions are quick to perform on a linked list. They are accomplished simply by changing a few references. These operations require $O(1)$ time (the fastest Big-O time).

Unfortunately, however, *finding* a specified element in a linked list is not so easy. You must start at the beginning of the list and visit each element until you find the one you're looking for. Thus you will need to visit an average of $N/2$ objects, comparing each one's key with the desired value. This is slow, requiring $O(N)$ time. (Notice that times considered fast for a sort are slow for data structure operations.)

You might think you could speed things up by using an ordered linked list, in which the elements were arranged in order, but this doesn't help. You still must start at the beginning and visit the elements in order, because there's no way to access a given element without following the chain of references to it. (Of course, in an ordered list it's much quicker to visit the nodes in order than it is in a non-ordered list, but that doesn't

help to find an arbitrary object.)

Trees to the Rescue

It would be nice if there were a data structure with the quick insertion and deletion of a linked list, and also the quick searching of an ordered array. Trees provide both these characteristics, and are also one of the most interesting data structures.

What Is a Tree?

We'll be mostly interested in a particular kind of tree called a *binary tree*, but let's start by discussing trees in general before moving on to the specifics of binary trees.

A tree consists of *nodes* connected by *edges*. Figure 8.1 shows a tree. In such a picture of a tree (or in our Workshop applet) the nodes are represented as circles, and the edges as lines connecting the circles.

Trees have been studied extensively as abstract mathematical entities, so there's a large amount of theoretical knowledge about them. A tree is actually an instance of a more general category called a graph, but we don't need to worry about that here. We'll discuss graphs in [Chapters 13, "Graphs,"](#) and [14, "Weighted Graphs."](#)

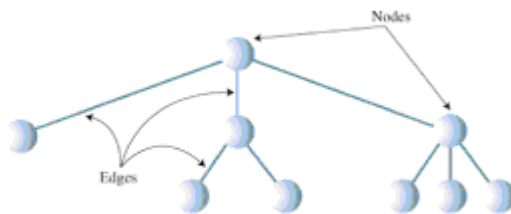

Figure 8.1: A tree

In computer programs, nodes often represent such entities as people, car parts, airline reservations, and so on; in other words, the typical items we store in any kind of data structure. In an OOP language such as Java, these real-world entities are represented by objects.

The lines (edges) between the nodes represent the way the nodes are related. Roughly speaking, the lines represent convenience: It's easy (and fast) for a program to get from one node to another if there is a line connecting them. In fact, the *only* way to get from node to node is to follow a path along the lines. Generally you are restricted to going in one direction along edges: from the root downward.

Edges are likely to be represented in a program by references, if the program is written in Java (or by pointers if the program is written in C or C++).

Typically there is one node in the top row of a tree, with lines connecting to more nodes on the second row, even more on the third, and so on. Thus trees are small on the top and large on the bottom. This may seem upside-down compared with real trees, but generally a program starts an operation at the small end of the tree, and it's (arguably) more natural to think about going from top to bottom, as in reading text.

There are different kinds of trees. The tree shown in [Figure 8.1](#) has more than two children per node. (We'll see what "children" means in a moment.) However, in this chapter we'll be discussing a specialized form of tree called a *binary tree*. Each node in a binary tree has a maximum of two children. More general trees, in which nodes can have more than two children, are called multiway trees. We'll see an example in [Chapter 10, "2-3-4 Tables and](#)

[External Storage,"](#) where we discuss 2-3-4 trees.

Why Use Binary Trees?

Why might you want to use a tree? Usually, because it combines the advantages of two other structures: an ordered array and a linked list. You can search a tree quickly, as you can an ordered array, and you can also insert and delete items quickly, as you can with a linked list. Let's explore these topics a bit before delving into the details of trees.

Slow Insertion in an Ordered Array

Imagine an array in which all the elements are arranged in order; that is, an ordered array, such as we saw in [Chapter 3, "Simple Sorting."](#) As we learned, it's quick to search such an array for a particular value, using a binary search. You check in the center of the array; if the object you're looking for is greater than what you find there, you narrow your search to the top half of the array; if it's less, you narrow your search to the bottom half. Applying this process repeatedly finds the object in $O(\log N)$ time. It's also quick to iterate through an ordered array, visiting each object in sorted order.

On the other hand, if you want to insert a new object into an ordered array, you first need to find where the object will go, and then move all the objects with greater keys up one space in the array to make room for it. These multiple moves are time consuming, requiring, on the average, moving half the items ($N/2$ moves). Deletion involves the same multimove operation, and is thus equally slow.

If you're going to be doing a lot of insertions and deletions, an ordered array is a bad choice.

Slow Searching in a Linked List

On the other hand, as we saw in [Chapter 7, "Advanced Sorting,"](#) insertions and deletions are quick to perform on a linked list. They are accomplished simply by changing a few references. These operations require $O(1)$ time (the fastest Big-O time).

Unfortunately, however, *finding* a specified element in a linked list is not so easy. You must start at the beginning of the list and visit each element until you find the one you're looking for. Thus you will need to visit an average of $N/2$ objects, comparing each one's key with the desired value. This is slow, requiring $O(N)$ time. (Notice that times considered fast for a sort are slow for data structure operations.)

You might think you could speed things up by using an ordered linked list, in which the elements were arranged in order, but this doesn't help. You still must start at the beginning and visit the elements in order, because there's no way to access a given element without following the chain of references to it. (Of course, in an ordered list it's much quicker to visit the nodes in order than it is in a non-ordered list, but that doesn't help to find an arbitrary object.)

Trees to the Rescue

It would be nice if there were a data structure with the quick insertion and deletion of a linked list, and also the quick searching of an ordered array. Trees provide both these characteristics, and are also one of the most interesting data structures.

What Is a Tree?

We'll be mostly interested in a particular kind of tree called a *binary tree*, but let's start by discussing trees in general before moving on to the specifics of binary trees.

A tree consists of *nodes* connected by *edges*. Figure 8.1 shows a tree. In such a picture of a tree (or in our Workshop applet) the nodes are represented as circles, and the edges as lines connecting the circles.

Trees have been studied extensively as abstract mathematical entities, so there's a large amount of theoretical knowledge about them. A tree is actually an instance of a more general category called a graph, but we don't need to worry about that here. We'll discuss graphs in [Chapters 13, "Graphs,"](#) and [14, "Weighted Graphs."](#)

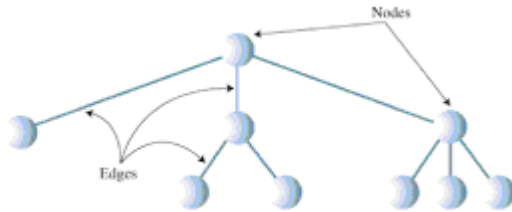

Figure 8.1: A tree

In computer programs, nodes often represent such entities as people, car parts, airline reservations, and so on; in other words, the typical items we store in any kind of data structure. In an OOP language such as Java, these real-world entities are represented by objects.

The lines (edges) between the nodes represent the way the nodes are related. Roughly speaking, the lines represent convenience: It's easy (and fast) for a program to get from one node to another if there is a line connecting them. In fact, the *only* way to get from node to node is to follow a path along the lines. Generally you are restricted to going in one direction along edges: from the root downward.

Edges are likely to be represented in a program by references, if the program is written in Java (or by pointers if the program is written in C or C++).

Typically there is one node in the top row of a tree, with lines connecting to more nodes on the second row, even more on the third, and so on. Thus trees are small on the top and large on the bottom. This may seem upside-down compared with real trees, but generally a program starts an operation at the small end of the tree, and it's (arguably) more natural to think about going from top to bottom, as in reading text.

There are different kinds of trees. The tree shown in [Figure 8.1](#) has more than two children per node. (We'll see what "children" means in a moment.) However, in this chapter we'll be discussing a specialized form of tree called a *binary tree*. Each node in a binary tree has a maximum of two children. More general trees, in which nodes can have more than two children, are called multiway trees. We'll see an example in [Chapter 10, "2-3-4 Tables and External Storage,"](#) where we discuss 2-3-4 trees.

An Analogy

One commonly encountered tree is the hierarchical file structure in a computer system. The root directory of a given device (designated with the backslash, as in `C:\`, on many systems) is the tree's root. The directories one level below the root directory are its children. There may be many levels of subdirectories. Files represent leaves; they have no children of their own.

Clearly a hierarchical file structure is not a binary tree, because a directory may have many children. A complete pathname, such as `C:\SALES\EAST\NOVEMBER\SMITH.DAT`, corresponds to the path from the root to the `SMITH.DAT` leaf. Terms used for the file structure, such as root and path, were borrowed

from tree theory.

A hierarchical file structure differs in a significant way from the trees we'll be discussing here. In the file structure, subdirectories contain no data; only references to other subdirectories or to files. Only files contain data. In a tree, every node contains data (a personnel record, car-part specifications, or whatever). In addition to the data, all nodes except leaves contain references to other nodes.

How Do Binary Trees Work?

Let's see how to carry out the common binary-tree operations of finding a node with a given key, inserting a new node, traversing the tree, and deleting a node. For each of these operations we'll first show how to use the Tree Workshop applet to carry it out; then we'll look at the corresponding Java code.

The Tree Workshop Applet

Start up the binary Tree Workshop applet. You'll see a screen something like that shown in Figure 8.5. However, because the tree in the Workshop applet is randomly generated, it won't look exactly the same as the tree in the figure.

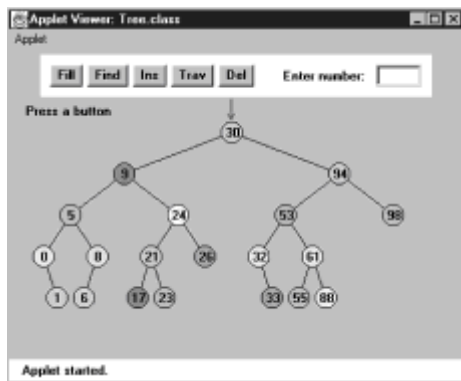

Figure 8.5: The binary Tree Workshop applet

Using the Applet

The key values shown in the nodes range from 0 to 99. Of course, in a real tree, there would probably be a larger range of key values. For example, if employees' Social Security numbers were used for key values, they would range up to 999,999,999.

Another difference between the Workshop applet and a real tree is that the Workshop applet is limited to a depth of 5; that is, there can be no more than 5 levels from the root to the bottom. This restriction ensures that all the nodes in the tree will be visible on the screen. In a real tree the number of levels is unlimited (until you run out of memory).

Using the Workshop applet, you can create a new tree whenever you want. To do this, click the Fill button. A prompt will ask you to enter the number of nodes in the tree. This can vary from 1 to 31, but 15 will give you a representative tree. After typing in the number, press Fill twice more to generate the new tree. You can experiment by creating trees with different numbers of nodes.

Unbalanced Trees

Notice that some of the trees you generate are *unbalanced*; that is, they have most of their nodes on one side of the root or the other, as shown in Figure 8.6. Individual

subtrees may also be unbalanced.

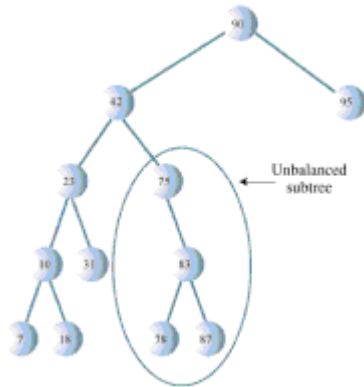

Figure 8.6: An unbalanced tree (with an unbalanced subtree)

Trees become unbalanced because of the order in which the data items are inserted. If these key values are inserted randomly, the tree will be more or less balanced. However, if an ascending sequence (like 11, 18, 33, 42, 65, and so on) or a descending sequence is generated, all the values will be right children (if ascending) or left children (if descending) and the tree will be unbalanced. The key values in the Workshop applet are generated randomly, but of course some short ascending or descending sequences will be created anyway, which will lead to local imbalances. When you learn how to insert items into the tree in the Workshop applet you can try building up a tree by inserting such an ordered sequence of items and see what happens.

If you ask for a large number of nodes when you use Fill to create a tree, you may not get as many nodes as you requested. Depending on how unbalanced the tree becomes, some branches may not be able to hold a full number of nodes. This is because the depth of the applet's tree is limited to five; the problem would not arise in a real tree.

If a tree is created by data items whose key values arrive in random order, the problem of unbalanced trees may not be too much of a problem for larger trees, because the chances of a long run of numbers in sequence is small. But key values can arrive in strict sequence; for example, when a data-entry person arranges a stack of personnel files into order of ascending employee number before entering the data. When this happens, tree efficiency can be seriously degraded. We'll discuss unbalanced trees and what to do about them in [Chapter 9, "Red-Black Trees."](#)

Representing the Tree in Java Code

Let's see how we might implement a binary tree in Java. As with other data structures, there are several approaches to representing a tree in the computer's memory. The most common is to store the nodes at unrelated locations in memory and connect them using references in each node that point to its children.

It's also possible to represent a tree in memory as an array, with nodes in specific positions stored in corresponding positions in the array. We'll return to this possibility at the end of this chapter. For our sample Java code we'll use the approach of connecting the nodes using references.

As we discuss individual operations we'll show code fragments pertaining to that operation. The complete program from which these fragments are extracted can be seen toward the end of this chapter in [Listing 8.1](#).

The Node Class

First, we need a class of node objects. These objects contain the data representing the objects being stored (employees in an employee database, for example) and also references to each of the node's two children. Here's how that looks:

```
class Node
{
    int iData;           // data used as key value
    float fData;        // other data
    node leftChild;     // this node's left child
    node rightChild;    // this node's right child

    public void displayNode()
    {
        // (see Listing 8.1 for method body)
    }
}
```

Some programmers also include a reference to the node's parent. This simplifies some operations but complicates others, so we don't include it. We do include a method called `displayNode()` to display the node's data, but its code isn't relevant here.

There are other approaches to designing class `Node`. Instead of placing the data items directly into the node, you could use a reference to an object representing the data item:

```
class Node
{
    person p1;           // reference to person object
    node leftChild;     // this node's left child
    node rightChild;    // this node's right child
}

class person
{
    int iData;
    float fData;
}
```

This makes it conceptually clearer that the node and the data item it holds aren't the same thing, but it results in somewhat more complicated code, so we'll stick to the first approach.

The Tree Class

We'll also need a class from which to instantiate the tree itself; the object that holds all the nodes. We'll call this class `Tree`. It has only one field: a `Node` variable that holds the root. It doesn't need fields for the other nodes because they are all accessed from the root.

The `Tree` class has a number of methods: some for finding, inserting, and deleting nodes, several for different kinds of traverses, and one to display the tree. Here's a skeleton version:

```

class Tree
{
    private Node root;           // the only data field in Tree

    public void find(int key)
    {
    }
    public void insert(int id, double dd)
    {
    }
    public void delete(int id)
    {
    }
    // various other methods

} // end class Tree

```

The TreeApp Class

Finally, we need a way to perform operations on the tree. Here's how you might write a class with a `main()` routine to create a tree, insert three nodes into it, and then search for one of them. We'll call this class `TreeApp`:

```

class TreeApp
{
    public static void main(String[] args)
    {
        Tree theTree = new Tree;           // make a tree

        theTree.insert(50, 1.5);          // insert 3 nodes
        theTree.insert(25, 1.7);
        theTree.insert(75, 1.9);

        node found = theTree.find(25);    // find node with key 25
        if(found != null)
            System.out.println("Found the node with key 25");
        else
            System.out.println("Could not find node with key 25");
    } // end main()

} // end class TreeApp

```

In [Listing 8.1](#) the `main()` routine provides a primitive user interface so you can decide from the keyboard whether you want to insert, find, delete, or perform other operations.

Next we'll look at individual tree operations: finding a node, inserting a node, traversing the tree, and deleting a node.

Finding a Node

Finding a node with a specific key is the simplest of the major tree operations, so let's start with that.

Remember that the nodes in a binary search tree correspond to objects containing information. They could be *person objects*, with an employee number as the key and also perhaps name, address, telephone number, salary, and other fields. Or they could represent car parts, with a part number as the key value and fields for quantity on hand, price, and so on. However, the only characteristics of each node that we can see in the Workshop applet are a number and a color. A node is created with these two characteristics and keeps them throughout its life.

Using the Workshop Applet to Find a Node

Look at the Workshop applet and pick a node, preferably one near the bottom of the tree (as far from the root as possible). The number shown in this node is its *key value*. We're going to demonstrate how the Workshop applet finds the node, given the key value.

For purposes of this discussion we'll assume you've decided to find the node representing the item with key value 57, as shown in Figure 8.7. Of course, when you run the Workshop applet you'll get a different tree and will need to pick a different key value.

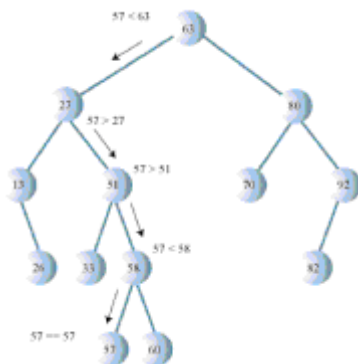

Figure 8.7: Finding node 57

Click the Find button. The prompt will ask for the value of the node to find. Enter 57 (or whatever the number is on the node you chose). Click Find twice more.

As the Workshop applet looks for the specified node, the prompt will display either "Going to left child" or "Going to right child," and the red arrow will move down one level to the right or left.

Figure 8.7 the arrow starts at the root. The program compares the key value 57 with the value at the root, which is 63. The key is less, so the program knows the desired node must be on the left side of the tree; either the root's left child or one of this child's descendants. The left child of the root has the value 27, so the comparison of 57 and 27 will show that the desired node is in the right subtree of 27. The arrow will go to 51, the root of this subtree. Here, 57 is again greater than the 51 node, so we go to the right, to 58, and then to the left, to 57. This time the comparison shows 57 equals the node's key value, so we've found the node we want.

The Workshop applet doesn't do anything with the node once it finds it, except to display a message saying it has been found. A serious program would perform some operation on the found node, such as displaying its contents or changing one of its fields.

Java Code for Finding a Node

Here's the code for the `find()` routine, which is a method of the `Tree` class:

```

public Node find(int key)           // find node with given key
{                                   // (assumes non-empty tree)
    Node current = root;           // start at root

    while(current.iData != key)     // while no match,
    {
        if(key < current.iData)    // go left?
            current = current.leftChild;
        else
            current = current.rightChild; // or go right?
        if(current == null)        // if no child,
            return null;           // didn't find it
    }
    return current;                // found it
}

```

This routine uses a variable `current` to hold the node it is currently examining. The argument `key` is the value to be found. The routine starts at the root. (It has to; this is the only node it can access directly.) That is, it sets `current` to the root.

Then, in the `while` loop, it compares the value to be found, `key`, with the value of the `iData` field (the key field) in the current node. If `key` is less than this field, then `current` is set to the node's left child. If `key` is greater than (or equal) to the node's `iData` field, then `current` is set to the node's right child.

Can't Find It

If `current` becomes equal to `null`, then we couldn't find the next child node in the sequence; we've reached the end of the line without finding the node we were looking for, so it can't exist. We return `null` to indicate this fact.

Found It

If the condition of the `while` loop is not satisfied, so that we exit from the bottom of the loop, then the `iData` field of `current` is equal to `key`; that is, we've found the node we want. We return the node, so that the routine that called `find()` can access any of the node's data.

Efficiency

As you can see, how long it takes to find a node depends on how many levels down it is situated. In the Workshop applet there can be up to 31 nodes, but no more than 5 levels—so you can find any node using a maximum of only 5 comparisons. This is $O(\log N)$ time, or more specifically $O(\log_2 N)$ time; the logarithm to the base 2. We'll discuss this further toward the end of this chapter.

Inserting a Node

To insert a node we must first find the place to insert it. This is much the same process as trying to find a node that turns out not to exist, as described in the section on Find. We follow the path from the root to the appropriate node, which will be the parent of the new node. Once this parent is found, the new node is connected as its left or right child, depending on whether the new node's key is less than or greater than that of the parent.

Using the Workshop Applet to Insert a Node

To insert a new node with the Workshop applet, press the `Ins` button. You'll be asked to type the key value of the node to be inserted. Let's assume we're going to insert a new node with the value 45. Type this into the text field.

The first step for the program in inserting a node is to find where it should be inserted. Figure 8.8a shows how this looks.

The value 45 is less than 60 but greater than 40, so we arrive at node 50. Now we want to go left because 45 is less than 50, but 50 has no left child; its `leftChild` field is null. When it sees this null, the insertion routine has found the place to attach the new node. The Workshop applet does this by creating a new node with the value 45 (and a randomly generated color) and connecting it as the left child of 50, as shown in Figure 8.8b.

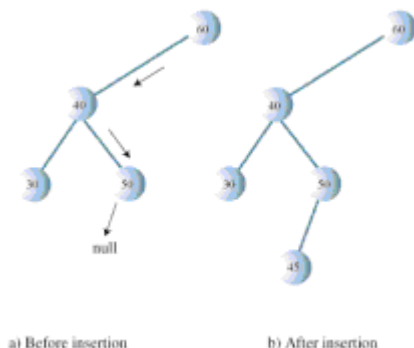

Figure 8.8: Inserting a node

Java Code for Inserting a Node

The `insert()` function starts by creating the new node, using the data supplied as arguments.

Next, `insert()` must determine where to insert the new node. This is done using roughly the same code as finding a node, described in the section on `find()`. The difference is that when you're simply trying to *find* a node and you encounter a null (non-existent) node, you know the node you're looking for doesn't exist so you return immediately. When you're trying to *insert* a node you insert it (creating it first, if necessary) before returning.

The value to be searched for is the data item passed in the argument `id`. The `while` loop uses `true` as its condition because it doesn't care if it encounters a node with the same value as `id`; it treats another node with the same key value as if it were simply greater than the key value. (We'll return to the subject of duplicate nodes later in this chapter.)

A place to insert a new node will always be found (unless you run out of memory); when it is, and the new node is attached, the `while` loop exits with a `return` statement.

Here's the code for the `insert()` function:

```
public void insert(int id, double dd)
```

```

{
Node newNode = new Node();    // make new node
newNode.iData = id;           // insert data
newNode.dData = dd;
if(root==null)                // no node in root
    root = newNode;
else                            // root occupied
{
    Node current = root;      // start at root
    Node parent;
    while(true)                // (exits internally)
    {
        parent = current;
        if(id < current.iData) // go left?
        {
            current = current.leftChild;
            if(current == null) // if end of the line,
            {
                // insert on left
                parent.leftChild = newNode;
                return;
            }
        } // end if go left
        else                    // or go right?
        {
            current = current.rightChild;
            if(current == null) // if end of the line
            {
                // insert on right
                parent.rightChild = newNode;
                return;
            }
        } // end else go right
    } // end while
} // end else not root
} // end insert()

// -----
-

```

We use a new variable, `parent` (the parent of `current`), to remember the last non-null node we encountered (50 in the figure). This is necessary because `current` is set to `null` in the process of discovering that its previous value did not have an appropriate child. If we didn't save `parent`, we'd lose track of where we were.

To insert the new node, change the appropriate child pointer in `parent` (the last non-null node you encountered) to point to the new node. If you were looking unsuccessfully for `parent`'s left child, you attach the new node as `parent`'s left child; if you were looking for its right child, you attach the new node as its right child. In [Figure 8.8](#), 45 is attached as the left child of 50.

Traversing the Tree

Traversing a tree means visiting each node in a specified order. This process is not as commonly used as finding, inserting, and deleting nodes. One reason for this is that

traversal is not particularly fast. But traversing a tree is useful in some circumstances and the algorithm is interesting. (It's also simpler than deletion, the discussion of which we want to defer as long as possible.)

There are three simple ways to traverse a tree. They're called *preorder*, *inorder*, and *postorder*. The order most commonly used for binary search trees is *inorder*, so let's look at that first, and then return briefly to the other two.

Inorder Traversal

An inorder traversal of a binary search tree will cause all the nodes to be visited *in ascending order*, based on their key values. If you want to create a sorted list of the data in a binary tree, this is one way to do it.

The simplest way to carry out a traversal is the use of recursion (discussed in [Chapter 6, "Recursion"](#)). A recursive method to traverse the entire tree is called with a node as an argument. Initially, this node is the root. The method needs to do only three things:

1. Call itself to traverse the node's left subtree
2. Visit the node
3. Call itself to traverse the node's right subtree

Remember that *visiting* a node means doing something to it: displaying it, writing it to a file, or whatever.

Traversals work with any binary tree, not just with binary search trees. The traversal mechanism doesn't pay any attention to the key values of the nodes; it only concerns itself with whether a node has children.

Java Code for Traversing

The actual code for inorder traversal is so simple we show it before seeing how traversal looks in the Workshop applet. The routine, `inOrder()`, performs the three steps already described. The visit to the node consists of displaying the contents of the node. Like any recursive function, there must be a base case: the condition that causes the routine to return immediately, without calling itself. In `inOrder()` this happens when the node passed as an argument is null. Here's the code for the `inOrder()` method:

```
private void inOrder(node localRoot)
{
    if(localRoot != null)
    {
        inOrder(localRoot.leftChild);
        localRoot.displayNode();
        inOrder(localRoot.rightChild);
    }
}
```

This method is initially called with the root as an argument:

```
inOrder(root);
```

After that, it's on its own, calling itself recursively until there are no more nodes to visit.

Traversing a 3-Node Tree

Let's look at a simple example to get an idea of how this recursive traversal routine works. Imagine traversing a tree with only three nodes: a root (A) with a left child (B) and a right child (C), as shown in Figure 8.9.

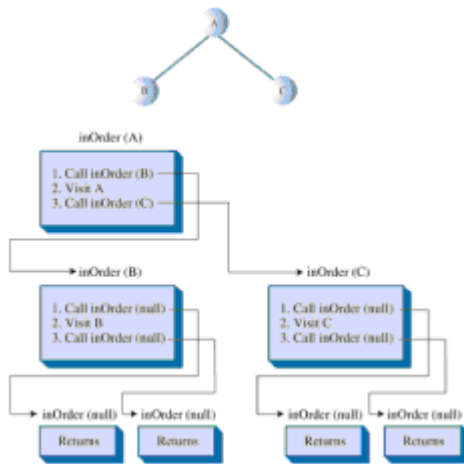

Figure 8.9: `inOrder()` method applied to 3-node tree

We start by calling `inOrder()` with the root A as an argument. This incarnation of `inOrder()` we'll call `inOrder(A)`. `inOrder(A)` first calls `inOrder()` with its left child, B, as an argument. This second incarnation of `inOrder()` we'll call `inOrder(B)`.

`inOrder(B)` now calls itself with its left child as an argument. However, it has no left child, so this argument is null. This creates an invocation of `inOrder()` we could call `inOrder(null)`. There are now three instances of `inOrder()` in existence: `inOrder(A)`, `inOrder(B)`, and `inOrder(null)`. However, `inOrder(null)` returns immediately when it finds its argument is null. (We all have days like that.)

Now `inOrder(B)` goes on to visit B; we'll assume this means to display it. Then `inOrder(B)` calls `inOrder()` again, with its right child as an argument. Again this argument is null, so the second `inOrder(null)` returns immediately. Now `inOrder(B)` has carried out steps 1, 2, and 3, so it returns (and thereby ceases to exist).

Now we're back to `inOrder(A)`, just returning from traversing A's left child. We visit A, and then call `inOrder()` again with C as an argument, creating `inOrder(C)`. Like `inOrder(B)`, `inOrder(C)` has no children, so step 1 returns with no action, step 2 visits C, and step 3 returns with no action. `inOrder(B)` now returns to `inOrder(A)`.

However, `inOrder(A)` is now done, so it returns and the entire traversal is complete. The order in which the nodes were visited is A, B, C; they have been visited *inorder*. In a binary search tree this would be the order of ascending keys.

More complex trees are handled similarly. The `inOrder()` function calls itself for each node, until it has worked its way through the entire tree.

Traversing with the Workshop Applet

To see what a traversal looks like with the Workshop applet, repeatedly press the Trav

button. (There's no need to type in any numbers.)

Here's what happens when you use the Tree Workshop applet to traverse inorder the tree shown in [Figure 8.10](#). This is slightly more complex than the 3-node tree seen previously. The red arrow starts at the root. [Table 8.1](#) shows the sequence of node keys and the corresponding messages. The key sequence is displayed at the bottom of the Workshop applet screen.

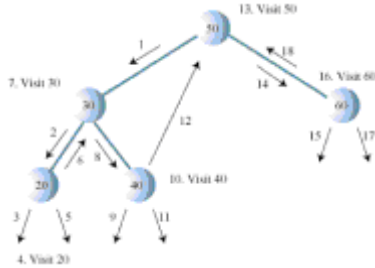

Figure 8.10: Traversing a tree inorder

Table 8.1: WORKSHOP APPLLET TRAVERSAL

Step Number	Red Arrow on Node	Message	List of Nodes Visited
1	50 (root)	Will check left child	
2	30	Will check left child	
3	20	Will check left child	
4	20	Will visit this node	
5	20	Will check right child	20
6	20	Will go to root of previous subtree	20
7	30	Will visit this node	20
8	30	Will check for right child	20 30
9	40	Will check left child	20 30
10	40	Will visit this node	20 30
11	40	Will check right child	20 30 40
12	40	Will go to root of previous subtree	20 30 40

13	50	Will visit this node	20 30 40
14	50	Will check right child	20 30 40 50
15	60	Will check left child	20 30 40 50
16	60	Will visit this node	20 30 40 50
17	60	Will check for right child	20 30 40 50 60
18	60	Will go to root of previous subtree	20 30 40 50 60
19	50	Done traversal	20 30 40 50 60

It may not be obvious, but for each node, the routine traverses the node's left subtree, visits the node, and traverses the right subtree. For example, for node 30 this happens in steps 2, 7, and 8.

All this isn't as complicated as it looks. The best way to get a feel for what's happening is to traverse a variety of different trees with the Workshop applet.

Preorder and Postorder Traversals

You can traverse the tree in two ways besides inorder; they're called preorder and post-order. It's fairly clear why you might want to traverse a tree inorder, but the motivation for preorder and postorder traversals is more obscure. However, these traversals are indeed useful if you're writing programs that *parse* or analyze algebraic expressions. Let's see why that should be true.

A binary tree (not a binary search tree) can be used to represent an algebraic expression that involves the binary arithmetic operators $+$, $-$, $/$, and $*$. The root node holds an operator, and each of its subtrees represents either a variable name (like A, B, or C) or another expression.

For example, the binary tree shown in Figure 8.11 represents the algebraic expression

$$A * (B + C)$$

This is called *infix* notation; it's the notation normally used in algebra. Traversing the tree inorder will generate the correct inorder sequence $A * B + C$, but you'll need to insert the parentheses yourself.

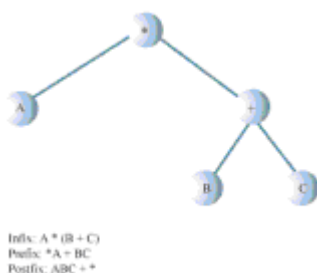

Figure 8.11: Tree representing an algebraic expression

What's all this got to do with preorder and postorder traversals? Let's see what's involved. For these other traversals the same three steps are used as for inorder, but in a different sequence. Here's the sequence for a `preorder()` method:

1. Visit the node.
2. Call itself to traverse the node's left subtree.
3. Call itself to traverse the node's right subtree.

Traversing the tree shown in [Figure 8.11](#) using preorder would generate the expression

`*A+BC`

This is called *prefix* notation. One of the nice things about it is that parentheses are never required; the expression is unambiguous without them. It means "apply the operator `*` to the next two things in the expression." These two things are `A` and `+BC`. The expression `+BC` means "apply `+` to the next two things in the expression;" which are `B` and `C`, so this last expression is `B+C` in inorder notation. Inserting that into the original expression `*A+BC` (preorder) gives us `A*(B+C)` in inorder.

The postorder traversal method contains the three steps arranged in yet another way:

1. Call itself to traverse the node's left subtree.
2. Call itself to traverse the node's right subtree.
3. Visit the node.

For the tree in [Figure 8.11](#), visiting the nodes with a postorder traversal would generate the expression

`ABC+*`

This is called *postfix* notation. As described in [Chapter 4, "Stacks and Queues,"](#) it means "apply the last operator in the expression, `*`, to the first and second things." The first thing is `A`, and the second thing is `BC+`.

`BC+` means "apply the last operator in the expression, `+`, to the first and second things." The first thing is `B` and the second thing is `C`, so this gives us `(B+C)` in infix. Inserting this in the original expression `ABC+*` (postfix) gives us `A*(B+C)` postfix.

The code in [Listing 8.1](#) contains methods for preorder and postorder traversals, as well as for inorder.

Finding Maximum and Minimum Values

Incidentally, we should note how easy it is to find the maximum and minimum values in a binary search tree. In fact, it's so easy we don't include it as an option in the Workshop applet, nor show code for it in [Listing 8.1](#). Still, it's important to understand how it works.

For the minimum, go to the left child of the root; then go to the left child of that child, and

so on, until you come to a node that has no left child. This node is the minimum, as shown in Figure 8.12.

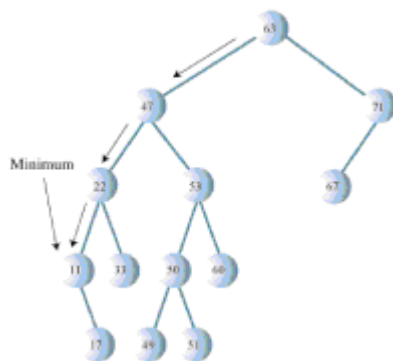

Figure 8.12: Minimum value of a tree

Here's some code that returns the node with the minimum key value:

```
public Node minimum()      // returns node with minimum key
value
{
    Node current, last;
    current = root;        // start at root
    while(current != null) // until the bottom,
    {
        last = current;    // remember node
        current = current.leftChild; // go to left child
    }
    return last;
}
```

We'll need to know about finding the minimum value when we set about deleting a node.

For the *maximum* value in the tree, follow the same procedure but go from right child to right child until you find a node with no right child. This node is the maximum. The code is the same except that the last statement in the loop is

```
current = current.rightChild; // go to right child
```

Deleting a Node

Deleting a node is the most complicated common operation required for binary search trees. However, deletion is important in many tree applications, and studying the details builds character.

You start by finding the node you want to delete, using the same approach we saw in `find()` and `insert()`. Once you've found the node, there are three cases to consider.

1. The node to be deleted is a leaf (has no children).
2. The node to be deleted has one child.
3. The node to be deleted has two children.

We'll look at these three cases in turn. The first is easy, the second almost as easy, and the third quite complicated.

Case 1: The Node to be Deleted Has No Children

To delete a leaf node, you simply change the appropriate child field in the node's parent to point to null instead of to the node. The node will still exist, but it will no longer be part of the tree. This is shown in Figure 8.13.

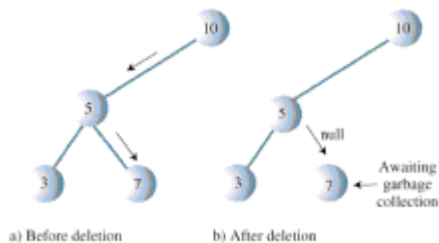

Figure 8.13: Deleting a node with no children

Because of Java's garbage collection feature, we don't need to worry about explicitly deleting the node itself. When Java realizes that nothing in the program refers to the node, it will be removed from memory. (In C and C++ you would need to execute `free()` or `delete()` to remove the node from memory.)

Using the Workshop Applet to Delete a Node With No Children

Assume you're going to delete node 7 in Figure 8.13. Press the Del button and enter 7 when prompted. Again, the node must be found before it can be deleted. Repeatedly pressing Del will take you from 10 to 5 to 7. When it's found, it's deleted without incident.

Java Code to Delete a Node With No Children

The first part of the `delete()` routine is similar to `find()` and `insert()`. It involves finding the node to be deleted. As with `insert()`, we need to remember the parent of the node to be deleted so we can modify its child fields. If we find the node, we drop out of the `while` loop with `parent` containing the node to be deleted. If we can't find it, we return from `delete()` with a value of `false`.

```
public boolean delete(int key) // delete node with given key
{
    // (assumes non-empty list)
    Node current = root;
    Node parent = root;
    boolean isLeftChild = true;

    while(current.iData != key) // search for node
    {
        parent = current;
        if(key < current.iData) // go left?
        {
            isLeftChild = true;
            current = current.leftChild;
        }
        else // or go right?
    }
```

```

    {
    isLeftChild = false;
    current = current.rightChild;
    }
if(current == null)           // end of the line,
    return false;           // didn't find it
} // end while
// found node to delete
// continues...

}

```

Once we've found the node, we check first to see whether it has no children. When this is true we check the special case of the root; if that's the node to be deleted, we simply set it to null, and this empties the tree. Otherwise, we set the parent's `leftChild` or `rightChild` field to null to disconnect the parent from the node.

```

// delete() continued...
// if no children, simply delete it
if(current.leftChild==null &&
    current.rightChild==null)
{
if(current == root)           // if root,
    root = null;             // tree is empty
else if(isLeftChild)
    parent.leftChild = null; // disconnect
else
    parent.rightChild = null; // from parent
}

// continues...

```

Case 2: The Node to be Deleted Has One Child

This case isn't so bad either. The node has only two connections: to its parent and to its only child. You want to "snip" the node out of this sequence by connecting its parent directly to its child. This involves changing the appropriate reference in the parent (`leftChild` or `rightChild`) to point to the deleted node's child. This is shown in Figure 8.14.

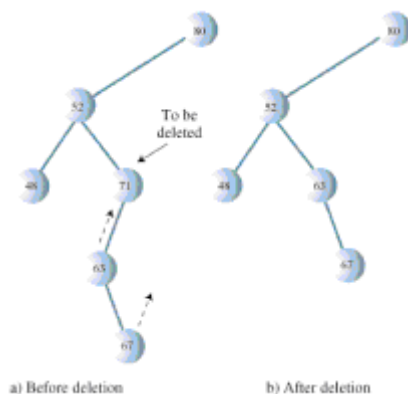

Figure 8.14: Deleting a node with one child

Using the Workshop Applet to Delete a Node with One Child

Let's assume we're using the Workshop on the tree in Figure 8.14, and deleting node 71, which has a left child but no right child. Press Del and enter 71 when prompted. Keep pressing Del until the arrow rests on 71. Node 71 has only one child, 63. It doesn't matter whether 63 has children of its own; in this case, it has one: 67.

Pressing Del once more causes 71 to be deleted. Its place is taken by its left child, 63. In fact, the entire subtree of which 63 is the root is moved up and plugged in as the new right child of 52.

Use the Workshop applet to generate new trees with one-child nodes, and see what happens when you delete them. Look for the subtree whose root is the deleted node's child. No matter how complicated this subtree is, it's simply moved up and plugged in as the new child of the deleted node's parent.

Java Code to Delete a Node With One Child

The following code shows how to deal with the one-child situation. There are four variations: the child of the node to be deleted may be either a left or right child, and for each of these cases the node to be deleted may be either the left or right child of its parent.

There is also a specialized situation: The node to be deleted may be the root, in which case it has no parent and is simply replaced by the appropriate subtree. Here's the code (which continues from the end of the no-child code fragment shown earlier):

```
// delete() continued...
// if no right child, replace with left subtree
else if(current.rightChild==null)
    if(current == root)
        root = current.leftChild;
    else if(isLeftChild)           // left child of parent
        parent.leftChild = current.leftChild;
    else                           // right child of parent
        parent.rightChild = current.leftChild;

// if no left child, replace with right subtree
else if(current.leftChild==null)
    if(current == root)
        root = current.rightChild;
    else if(isLeftChild)           // left child of parent
        parent.leftChild = current.rightChild;
    else                           // right child of parent
        parent.rightChild = current.rightChild;

// continued...
```

Notice that working with references makes it easy to move an entire subtree. You do this by simply disconnecting the old reference to the subtree and creating a new reference to it somewhere else. Although there may be lots of nodes in the subtree, you don't need to worry about moving them individually. In fact, they only "move" in the sense of being conceptually in different positions relative to the other nodes. As far as the program is concerned, only the reference to the root of the subtree has changed.

Case 3: The Node to be Deleted Has Two Children

Now the fun begins. If the deleted node has two children, you can't just replace it with one of these children, at least if the child has its own children. Why not? Examine [Figure 8.15](#), and imagine deleting node 25 and replacing it with its right subtree, whose root is 35. Which left child would 35 have? The deleted node's left child, 15, or the new node's left child, 30? In either case 30 would be in the wrong place, but we can't just throw it away.

We need another approach. The good news is that there's a trick. The bad news is that, even with the trick, there are a lot of special cases to consider. Remember that in a binary search tree the nodes are arranged in order of ascending keys. For each node, the node with the next-highest key is called its *inorder successor*, or simply its successor. In [Figure 8.15a](#), node 30 is the successor of node 25.

Here's the trick: To delete a node with two children, *replace the node with its inorder successor*. [Figure 8.16](#) shows a deleted node being replaced by its successor. Notice that the nodes are still in order. (There's more to it if the successor itself has children; we'll look at that possibility in a moment.)

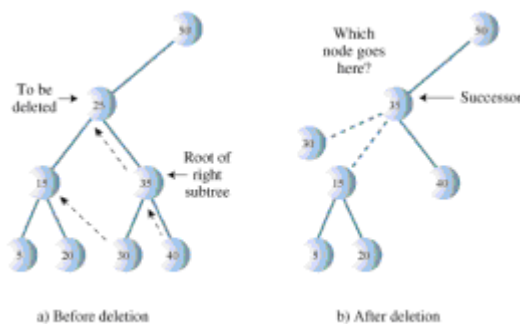

Figure 8.15: Can't replace with subtree

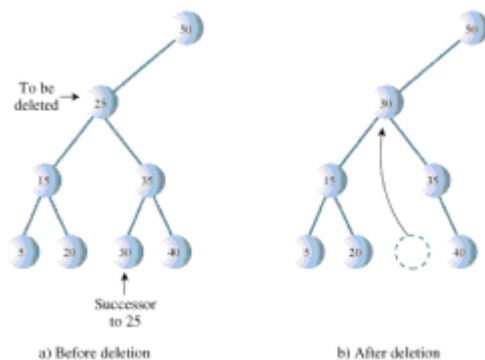

Figure 8.16: Node replaced by its successor

Finding the Successor

How do you find the successor of a node? As a human being, you can do this quickly (for small trees, anyway). Just take a quick glance at the tree and find the next-largest number following the key of the node to be deleted. In [Figure 8.16](#) it doesn't take long to see that the successor of 25 is 30. There's just no other number which is greater than 25 and also smaller than 35. However, the computer can't do things "at a glance," it needs an algorithm.

First the program goes to the original node's right child, which must have a key larger than the node. Then it goes to this right child's left child (if it has one), and to this left child's left child, and so on, following down the path of left children. The last left child in this path is the successor of the original node, as shown in Figure 8.17.

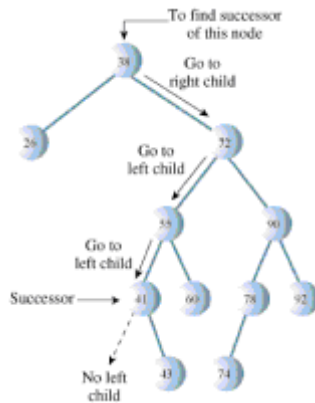

Figure 8.17: Finding the successor

Why does this work? What we're really looking for is *the smallest of the set of nodes that are larger than the original node*. When you go to the original node's right child, all the nodes in the resulting subtree are greater than the original node, because this is how a binary search tree is defined. Now we want the smallest value in this subtree. As we learned, you can find the minimum value in a subtree by following the path down all the left children. Thus, this algorithm finds the minimum value that is greater than the original node; this is what we mean by its successor.

If the right child of the original node has no left children, then this right child is itself the successor, as shown in Figure 8.18.

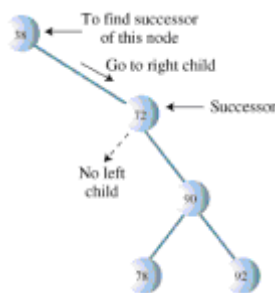

Figure 8.18: The right child is the successor

Using the Workshop Applet to Delete a Node with Two Children

Generate a tree with the Workshop applet, and pick a node with two children. Now mentally figure out which node is its successor by going to its right child and then following down the line of this right child's left children (if it has any). You may want to make sure the successor has no children of its own. If it does, the situation gets more complicated because entire subtrees are moved around, rather than a single node.

Once you've chosen a node to delete, click the Del button. You'll be asked for the key value of the node to delete. When you've specified it, repeated presses of the Del button will show the red arrow searching down the tree to the designated node. When the node is deleted, it's replaced by its successor.

In the example shown in [Figure 8.15](#), the red arrow will go from the root at 50 to 25; then 25 will be replaced by 30.

Java Code to Find the Successor

Here's some code for a method `getSuccessor()`, which returns the successor of the node specified as its `delNode` argument. (This routine assumes that `delNode` does indeed have a right child, but we know this is true because we've already determined that the node to be deleted has two children.)

```
// returns node with next-highest value after delNode
// goes to right child, then right child's left descendants

private node getSuccessor(node delNode)

{
    Node successorParent = delNode;
    Node successor = delNode;
    Node current = delNode.rightChild;    // go to right child
    while(current != null)                // until no more
    {                                       // left children,
        successorParent = successor;
        successor = current;
        current = current.leftChild;      // go to left child
    }                                     // if successor not

    if(successor != delNode.rightChild)  // right child,
    {                                       // make connections
        successorParent.leftChild = successor.rightChild;
        successor.rightChild = delNode.rightChild;
    }

    return successor;
}
```

The routine first goes to `delNode`'s right child, then, in the `while` loop, follows down the path of all this right child's left children. When the `while` loop exits, `successor` contains `delNode`'s successor.

Once we've found the successor, we may need to access its parent, so within the `while` loop we also keep track of the parent of the current node.

The `getSuccessor()` routine carries out two additional operations in addition to finding the successor. However, to understand these, we need to step back and consider the big picture.

As we've seen, the successor node can occupy one of two possible positions relative to `current`, the node to be deleted. The successor can be `current`'s right child, or it can be one of this right child's left descendants. We'll look at these two situations in turn.

successor Is Right Child of `delNode`

If `successor` is the right child of `delNode`, things are simplified somewhat because we

can simply move the subtree of which successor is the root and plug it in where the deleted node was. This requires only two steps:

1. Unplug `current` from the `rightChild` field of its parent (or `leftChild` field if appropriate), and set this field to point to `successor`.
2. Unplug `current`'s left child from `current`, and plug it into the `leftChild` field of `successor`.

Here are the code statements that carry out these steps, excerpted from `delete()`:

1. `parent.rightChild = successor;`
2. `successor.leftChild = current.leftChild;`

This situation is summarized in Figure 8.19, which shows the connections affected by these two steps.

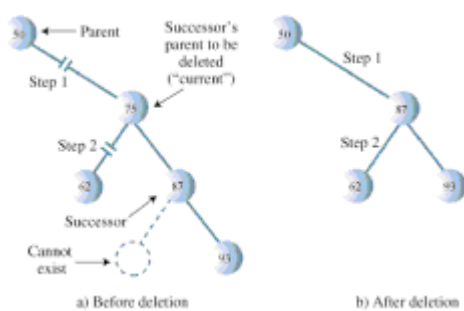

Figure 8.19: Deletion when successor is right child

Here's the code in context (a continuation of the `else-if` ladder shown earlier):

```
// delete() continued

else // two children, so replace with inorder successor
{
    // get successor of node to delete (current)
    Node successor = getSuccessor(current);

    // connect parent of current to successor instead
    if(current == root)
        root = successor;
    else if(isLeftChild)
        parent.leftChild = successor;
    else
        parent.rightChild = successor;
    // connect successor to current's left child
    successor.leftChild = current.leftChild;
} // end else two children

// (successor cannot have a left child)
return true;

} // end delete()
```

Notice that this is—finally—the end of the `delete()` routine. Let's review the code for these two steps.

Step 1: If the node to be deleted, `current`, is the root, it has no parent so we merely set the root to the successor. Otherwise, the node to be deleted can be either a left or right child (the figure shows it as a right child), so we set the appropriate field in its parent to point to `successor`. Once `delete()` returns and `current` goes out of scope, the node referred to by `current` will have no references to it, so it will be discarded during Java's next garbage collection.

Step 2: We set the left child of `successor` to point to `current`'s left child.

What happens if the successor has children of its own? First of all, *a successor node is guaranteed not to have a left child*. This is true whether the successor is the right child of the node to be deleted or one of this right child's left children. How do we know this?

Well, remember that the algorithm we use to determine the successor goes to the right child first, and then to any left children of that right child. It stops when it gets to a node with no left child, so the algorithm itself determines that the successor can't have any left children. If it did, that left child would be the successor instead.

You can check this out on the Workshop applet. No matter how many trees you make, you'll never find a situation in which a node's successor has a left child (assuming the original node has two children, which is the situation that leads to all this trouble in the first place).

On the other hand, the successor may very well have a right child. This isn't much of a problem when the successor is the right child of the node to be deleted. When we move the successor, its right subtree simply follows along with it. There's no conflict with the right child of the node being deleted, because the successor *is* this right child.

In the next section we'll see that a successor's right child needs more attention if the successor is not the right child of the node to be deleted.

successor Is Left Descendant of Right Child of `delNode`

If `successor` is a left descendant of the right child of the node to be deleted, four steps are required to perform the deletion:

1. Plug the right child of `successor` into the `leftChild` field of the successor's parent.
2. Plug the right child of the node to be deleted into the `rightChild` field of `successor`.
3. Unplug `current` from the `rightChild` field of its parent, and set this field to point to `successor`.
4. Unplug `current`'s left child from `current`, and plug it into the `leftChild` field of `successor`.

Steps 1 and 2 are handled in the `getSuccessor()` routine, while 3 and 4 are carried in `delete()`. Figure 8.20 shows the connections affected by these four steps.

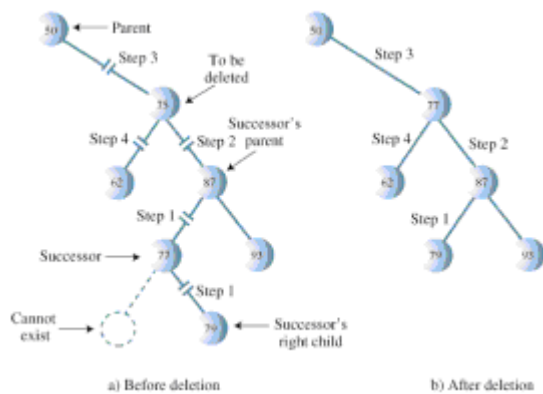

Figure 8.20: Deletion when successor is left child

Here's the code for these four steps:

1. `successorParent.leftChild = successor.rightChild;`
2. `successor.rightChild = delNode.rightChild;`
3. `parent.rightChild = successor;`
4. `successor.leftChild = current.leftChild;`

(Step 3 could also refer to the left child of its parent.) The numbers in Figure 8.20 show the connections affected by the four steps. Step 1 in effect *replaces the successor with its right subtree*. Step 2 keeps the right child of the deleted node in its proper place (this happens automatically when the successor is the right child of the deleted node). Steps 1 and 2 are carried out in the `if` statement that ends the `getSuccessor()` method shown earlier. Here's that statement again:

```

// if successor not
if(successor != delNode.rightChild) // right child,
{
    // make connections
    successorParent.leftChild = successor.rightChild;
    successor.rightChild = delNode.rightChild;
}

```

These steps are more convenient to perform here than in `delete()`, because in `getSuccessor()` it's easy to figure out where the successor's parent is while we're descending the tree to find the successor.

Steps 3 and 4 we've seen already; they're the same as steps 1 and 2 in the case where the successor is the right child of the node to be deleted, and the code is in the `if` statement at the end of `delete()`.

Is Deletion Necessary?

If you've come this far, you can see that deletion is fairly involved. In fact, it's so complicated that some programmers try to sidestep it altogether. They add a new Boolean field to the `node` class, called something like `isDeleted`. To delete a node, they simply set this field to `true`. Then other operations, like `find()`, check this field to

be sure the node isn't marked as deleted before working with it. This way, deleting a node doesn't change the structure of the tree. Of course, it also means that memory can fill up with "deleted" nodes.

This approach is a bit of a cop-out, but it may be appropriate where there won't be many deletions in a tree. (If ex-employees remain in the personnel file forever, for example.)

The Efficiency of Binary Trees

As you've seen, most operations with trees involve descending the tree from level to level to find a particular node. How long does it take to do this? In a full tree, about half the nodes are on the bottom level. (Actually there's one more node on the bottom row than in the rest of the tree.) Thus about half of all searches or insertions or deletions require finding a node on the lowest level. (An additional quarter of these operations require finding the node on the next-to-lowest level, and so on.)

During a search we need to visit one node on each level so we can get a good idea how long it takes to carry out these operations by knowing how many levels there are. Assuming a full tree, Table 8.2 shows how many levels are necessary to hold a given number of nodes.

Table 8.2: NUMBER OF LEVELS FOR SPECIFIED NUMBER OF NODES

Number of Nodes	Number of Levels
1	1
3	2
7	3
15	4
31	5
...	...
1,023	10
...	...
32,767	15
...	...
1,048,575	20
...	...
33,554,432	25

...

1,073,741,824

...

30

This situation is very much like the ordered array discussed in [Chapter 3](#). In that case, the number of comparisons for a binary search was approximately equal to the base-2 logarithm of the number of cells in the array. Here, if we call the number of nodes in the first column N, and the number of levels in the second column L, then we can say that N is 1 less than 2 raised to the power L, or

$$N = 2^L - 1$$

Adding 1 to both sides of the equation, we have

$$N+1 = 2^L$$

This is equivalent to

$$L = \log_2(N+1)$$

Thus the time needed to carry out the common tree operations is proportional to the base-2 log of N. In Big-O notation we say such operations take $O(\log N)$ time.

If the tree isn't full, analysis is difficult. We can say that for a tree with a given number of levels, average search times will be shorter for the non-full tree than the full tree because fewer searches will proceed to lower levels.

Compare the tree to the other data-storage structures we've discussed so far. In an unordered array or a linked list containing 1,000,000 items, it would take you on the average 500,000 comparisons to find the one you wanted. But in a tree of 1,000,000 items, it takes 20 (or fewer) comparisons.

In an ordered array you can find an item equally quickly, but inserting an item requires, on the average, moving 500,000 items. Inserting an item in a tree with 1,000,000 items requires 20 or fewer comparisons, plus a small amount of time to connect the item.

Similarly, deleting an item from a 1,000,000-item array requires moving an average of 500,000 items, while deleting an item from a 1,000,000-node tree requires 20 or fewer comparisons to find the item, plus (possibly) a few more comparisons to find its successor, plus a short time to disconnect the item and connect its successor.

Thus a tree provides high efficiency for all the common data-storage operations.

Traversing is not as fast as the other operations. However, traversals are probably not very commonly carried out in a typical large database. They're more appropriate when a tree is used as an aid to parsing algebraic or similar expressions, which are probably not too long anyway.

Trees Represented as Arrays

Our code examples are based on the idea that a tree's edges are represented by `leftChild` and `rightChild` references in each node. However, there's a completely different way to represent a tree: with an array.

In the array approach, the nodes are stored in an array and are not linked by references.

The position of the node in the array corresponds to its position in the tree. The node at index 0 is the root, the node at index 1 is the root's left child, and so on, progressing from left to right along each level of the tree. This is shown in Figure 8.21.

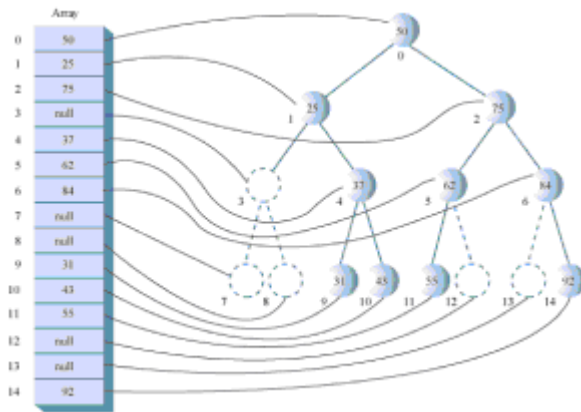

Figure 8.21: Tree represented by an array

Every position in the tree, whether it represents an existing node or not, corresponds to a cell in the array. Adding a node at a given position in the tree means inserting the node into the equivalent cell in the array. Cells representing tree positions with no nodes are filled with zero or `null`.

With this scheme, a node's children and parent can be found by applying some simple arithmetic to the node's index number in the array. If a node's index number is `index`, then this node's left child is

$$2 * \text{index} + 1$$

its right child is

$$2 * \text{index} + 2$$

and its parent is

$$(\text{index} - 1) / 2$$

(where the `'/'` character indicates integer division with no remainder). You can check this out by looking at the figure.

In most situations, representing a tree with an array isn't very efficient. Unfilled nodes and deleted nodes leave holes in the array, wasting memory. Even worse, when deletion of a node involves moving subtrees, every node in the subtree must be moved to its new location in the array, which is time-consuming in large trees.

However, if deletions aren't allowed, then the array representation may be useful, especially if obtaining memory for each node dynamically is, for some reason, too time-consuming. The array representation may also be useful in special situations. The tree in the Workshop applet, for example, is represented internally as an array to make it easy to map the nodes from the array to fixed locations on the screen display.

Duplicate Keys

As in other data structures, the problem of duplicate keys must be addressed. In the code

shown for `insert()`, and in the Workshop applet, a node with a duplicate key will be inserted as the right child of its twin.

The problem is that the `find()` routine will find only the first of two (or more) duplicate nodes. The `find()` routine could be modified to check an additional data item, to distinguish data items even when the keys were the same, but this would be (at least somewhat) time-consuming.

One option is to simply forbid duplicate keys. When duplicate keys are excluded by the nature of the data (employee ID numbers, for example) there's no problem. Otherwise, you need to modify the `insert()` routine to check for equality during the insertion process, and abort the insertion if a duplicate is found.

The Fill routine in the Workshop applet excludes duplicates when generating the random keys.

Duplicate Keys

As in other data structures, the problem of duplicate keys must be addressed. In the code shown for `insert()`, and in the Workshop applet, a node with a duplicate key will be inserted as the right child of its twin.

The problem is that the `find()` routine will find only the first of two (or more) duplicate nodes. The `find()` routine could be modified to check an additional data item, to distinguish data items even when the keys were the same, but this would be (at least somewhat) time-consuming.

One option is to simply forbid duplicate keys. When duplicate keys are excluded by the nature of the data (employee ID numbers, for example) there's no problem. Otherwise, you need to modify the `insert()` routine to check for equality during the insertion process, and abort the insertion if a duplicate is found.

The Fill routine in the Workshop applet excludes duplicates when generating the random keys.

Summary

- Trees consist of nodes (circles) connected by edges (lines).
- The root is the topmost node in a tree; it has no parent.
- In a binary tree, a node has at most two children.
- In a binary search tree, all the nodes that are left descendants of node A have key values less than A; all the nodes that are A's right descendants have key values greater than (or equal to) A.
- Trees perform searches, insertions, and deletions in $O(\log N)$ time.
- Nodes represent the data-objects being stored in the tree.
- Edges are most commonly represented in a program by references to a node's children (and sometimes to its parent).
- Traversing a tree means visiting all its nodes in some order.

- The simplest traversals are preorder, inorder, and postorder.
- An unbalanced tree is one whose root has many more left descendants than right descendants, or vice versa.
- Searching for a node involves comparing the value to be found with the key value of a node, and going to that node's left child if the key search value is less, or to the node's right child if the search value is greater.
- Insertion involves finding the place to insert the new node, and then changing a child field in its new parent to refer to it.
- An inorder traversal visits nodes in order of ascending keys.
- Preorder and postorder traversals are useful for parsing algebraic expressions.
- When a node has no children, it can be deleted by setting the child field in its parent to null.
- When a node has one child, it can be deleted by setting the child field in its parent to point to its child.
- When a node has two children, it can be deleted by replacing it with its successor.
- The successor to a node A can be found by finding the minimum node in the subtree whose root is A's right child.
- In a deletion of a node with two children, different situations arise, depending on whether the successor is the right child of the node to be deleted or one of the right child's left descendants.
- Nodes with duplicate key values may cause trouble in arrays because only the first one can be found in a search.
- Trees can be represented in the computer's memory as an array, although the reference-based approach is more common.

Chapter 9: Red-Black Trees

Overview

As you learned in the [last chapter](#), ordinary binary search trees offer important advantages as data storage devices: You can quickly search for an item with a given key, and you can also quickly insert or delete an item. Other data storage structures, such as arrays, sorted arrays, and linked lists, perform one or the other of these activities slowly. Thus binary search trees might appear to be the ideal data storage structure.

Unfortunately, ordinary binary search trees suffer from a troublesome problem. They work well if the data is inserted into the tree in random order. However, they become much slower if data is inserted in already sorted order (17, 21, 28, 36,...) or inversely sorted order (36, 28, 21, 17,...). When the values to be inserted are already ordered, a binary tree becomes unbalanced. With an unbalanced tree, the capability to quickly find (or insert or delete) a given element is lost.

This chapter explores one way to solve the problem of unbalanced trees: the red-black tree, which is a binary search tree with some added features.

There are other ways to ensure that trees are balanced. We'll mention some at the end of this chapter, and examine one, the 2-3-4 tree, in [Chapter 10, "2-3-4 Tables and External Storage."](#) However, the red-black tree is in most cases the most efficient balanced tree, at least when data is stored in memory as opposed to external files.

Our Approach to the Discussion

We'll explain insertion into red-black trees a little differently than we have explained insertion into other data structures. Red-black trees are not trivial to understand. Because of this and also because of a multiplicity of symmetrical cases (for left or right children, and inside or outside grandchildren) the actual code is more lengthy and complex than one might expect. It's therefore hard to learn about the algorithm by examining code.

Conceptual

For this reason, we're going to concentrate on conceptual understanding rather than coding details. In this we will be aided by the RBTree Workshop applet. We'll describe how you can work in partnership with the applet to insert new nodes into a tree. Including a human in the insertion routine certainly slows it down, but it also makes it easier for the human to understand how the process works.

Searching works the same way in a red-black tree as it does in an ordinary binary tree. On the other hand, insertion and deletion, while based on the algorithms in an ordinary tree, are extensively modified. Accordingly, in this chapter we'll be concentrating on the insertion process.

Top-Down Insertion

In this chapter, the approach to insertion that we'll discuss is called *top-down* insertion. This means that some structural changes may be made to the tree as the search routine descends the tree looking for the place to insert the node.

Another approach is *bottom-up* insertion. This involves finding the place to insert the node and then working back up through the tree making structural changes. Bottom-up insertion is less efficient because two passes must be made through the tree.

Balanced and Unbalanced Trees

Before we begin our investigation of red-black trees, let's review how trees become unbalanced. Fire up the Tree Workshop applet from [Chapter 8, "Binary Trees,"](#) (not this chapter's RBTree applet). Use the Fill button to create a tree with only one node. Then insert a series of nodes whose keys are in either ascending or descending order. The result will be something like that in Figure 9.1.

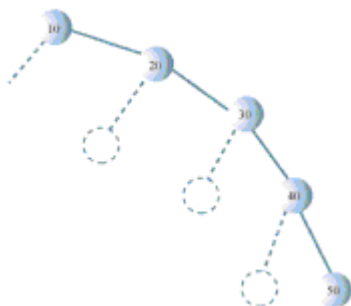

Figure 9.1: Items inserted in ascending order

The nodes arrange themselves in a line with no branches. Because each node is larger than the previously inserted one, every node is a right child, so all the nodes are on one side of the root. The tree is maximally unbalanced. If you inserted items in descending order, every node would be the left child of its parent; the tree would be unbalanced on the other side.

Degenerates to $O(N)$

When there are no branches, the tree becomes, in effect, a linked list. The arrangement of data is one-dimensional instead of two-dimensional. Unfortunately, as with a linked list, you must now search through (on the average) half the items to find the one you're looking for. In this situation the speed of searching is reduced to $O(N)$, instead of $O(\log N)$ as it is for a balanced tree. Searching through 10,000 items in such an unbalanced tree would require an average of 5,000 comparisons, whereas for a balanced tree with random insertions it requires only 14. For presorted data you might just as well use a linked list in the first place.

Data that's only partly sorted will generate trees that are only partly unbalanced. If you use the Tree Workshop applet from [Chapter 8](#) to attempt to generate trees with 31 nodes, you'll see that some of them are more unbalanced than others, as shown in Figure 9.2.

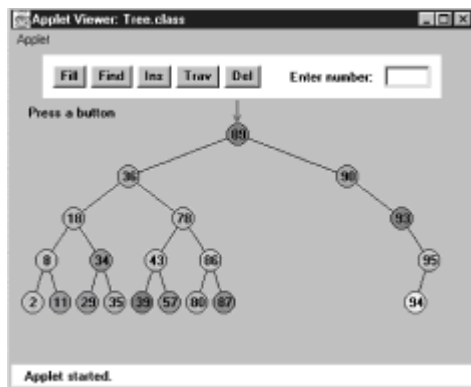

Figure 9.2: A partially unbalanced tree

Although not as bad as a maximally unbalanced tree, this situation is not optimal for searching times.

In the Tree Workshop applet, trees can become partially unbalanced, even with randomly generated data, because the amount of data is so small that even a short run of ordered numbers will have a big effect on the tree. Also, a very small or very large key value can cause an unbalanced tree by not allowing the insertion of many nodes on one side or the other. A root of 3, for example, allows only two more nodes to be inserted to its left.

With a realistic amount of random data it's not likely a tree would become seriously unbalanced. However, there may be runs of sorted data that will partially unbalance a tree. Searching partially unbalanced trees will take time somewhere between $O(N)$ and $O(\log N)$, depending on how badly the tree is unbalanced.

Balance to the Rescue

To guarantee the quick $O(\log N)$ search times a tree is capable of, we need to ensure that our tree is always balanced (or at least almost balanced). This means that each node in a tree needs to have roughly the same number of descendents on its left side as it has on its right.

In a red-black tree, balance is achieved during insertion (and also deletion, but we'll ignore that for the moment). As an item is being inserted, the insertion routine checks that certain characteristics of the tree are not violated. If they are, it takes corrective action, restructuring the tree as necessary. By maintaining these characteristics, the tree is kept balanced.

Red-Black Tree Characteristics

What are these mysterious tree characteristics? There are two, one simple and one more complicated:

- The nodes are colored.
- During insertion and deletion, rules are followed that preserve various arrangements of these colors.

Colored Nodes

In a red-black tree, every node is either black or red. These are arbitrary colors; blue and yellow would do just as well. In fact, the whole concept of saying that nodes have "colors" is somewhat arbitrary. Some other analogy could have been used instead: We could say that every node is either heavy or light, or yin or yang. However, colors are convenient labels. A data field, which can be boolean (`isRed`, for example), is added to the node class to embody this color information.

In the RBTree Workshop applet, the red/black characteristic of a node is shown by its border color. The center color, as it was in the Tree applet in the [last chapter](#), is simply a randomly generated data field of the node.

When we speak of a node's color in this chapter we'll almost always be referring to its red-black border color. In the figures (except the screen shot of [Figure 9.2](#)) we'll show black nodes with a solid black border and red nodes with a white border. (Nodes are sometimes shown with no border to indicate that it doesn't matter whether they're black or red.)

Red-Black Rules

When inserting (or deleting) a new node, certain rules, which we call the *red-black rules*, must be followed. If they're followed, the tree will be balanced. Let's look briefly at these rules:

1. Every node is either red or black.
2. The root is always black.
3. If a node is red, its children must be black (although the converse isn't necessarily true).
4. Every path from the root to a leaf, or to a null child, must contain the same number of black nodes.

The "null child" referred to in Rule 4 is a place where a child could be attached to a non-leaf node. In other words, it's the potential left child of a node with a right child, or the potential right child of a node with a left child. This will make more sense as we go along.

The number of black nodes on a path from root to leaf is called the *black height*. Another way to state Rule 4 is that the black height must be the same for all paths from the root to a leaf.

These rules probably seem completely mysterious. It's not obvious how they will lead to a balanced tree, but they do; some very clever people invented them. Copy them onto a sticky note, and keep it on your computer. You'll need to refer to them often in the course of this chapter.

You can see how the rules work by using the RBTre Workshop applet. We'll do some experiments with the applet in a moment, but first you should understand what actions you can take to fix things if one of the red-black rules is broken.

Duplicate Keys

What happens if there's more than one data item with the same key? This presents a slight problem in red-black trees. It's important that nodes with the same key are distributed on both sides of other nodes with the same key. That is, if keys arrive in the order 50, 50, 50, you want the second 50 to go to the right of the first one, and the third 50 to go to the left of the first one. Otherwise, the tree becomes unbalanced.

This could be handled by some kind of randomizing process in the insertion algorithm. However, the search process then becomes more complicated if all items with the same key must be found.

It's simpler to outlaw items with the same key. In this discussion we'll assume duplicates aren't allowed.

The Actions

Suppose you see (or are told by the applet) that the color rules are violated. How can you fix things so your tree is in compliance? There are two, and only two, possible actions you can take:

- You can change the colors of nodes.
- You can perform rotations.

Changing the color of a node means changing its red-black border color (not the center color). A rotation is a rearrangement of the nodes that hopefully leaves the tree more balanced.

At this point such concepts probably seem very abstract, so let's become familiar with the RBTre Workshop applet, which can help to clarify things.

Using the RBTre Workshop Applet

Figure 9.3 shows what the RBTre Workshop applet looks like after some nodes have been inserted. (It may be hard to tell the difference between red and black node borders in the figure, but they should be clear on a color monitor.)

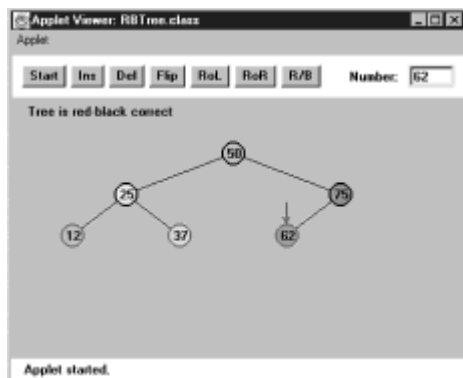

Figure 9.3: The RBTTree Workshop applet

There are quite a few buttons in the RBTTree applet. We'll briefly review what they do, although at this point some of the descriptions may be a bit puzzling. Soon we'll do some experimenting with these buttons.

Clicking on a Node

The red arrow points to the currently selected node. It's this node whose color is changed or which is the top node in a rotation. You select a node by single-clicking it with the mouse. This moves the red arrow to the node.

The Start Button

When you first start the Workshop applet, and also when you press the Start button, you'll see that a tree is created that contains only one node. Because an understanding of red-black trees focuses on using the red-black rules during the insertion process, it's more convenient to begin with the root and build up the tree by inserting additional nodes. To simplify future operations, the initial root node is always given a value of 50. (You select your own numbers for subsequent insertions.)

The Ins Button

The Ins button causes a new node to be created, with the value that was typed into the Number box, and then inserted into the tree. (At least this is what happens if no color flips are necessary. See the section on the Flip button for more on this possibility.)

Notice that the Ins button does a complete insertion operation with one push; multiple pushes are not required as they were with the Tree Workshop applet in the [last chapter](#). The focus in the RBTTree applet is not on the process of finding the place to insert the node, which is similar to that in ordinary binary search trees, but on keeping the tree balanced, so the applet doesn't show the individual steps in the insertion.

The Del Button

Pushing the Del button causes the node with the key value typed into the Number box to be deleted. As with the Ins button, this takes place immediately after the first push; multiple pushes are not required.

The Del button and the Ins button use the basic insertion algorithms; the same as those in the Tree Workshop applet. This is how the work is divided between the applet and the user: the applet does the insertion, but it's (mostly) up to the user to make the appropriate changes to the tree to ensure the red-black rules are followed and the tree thereby becomes balanced.

The Flip Button

If there is a black parent with two red children, and you place the red arrow on the parent by clicking on the node with the mouse, then when you press the Flip button the parent will become red and the children will become black. That is, the colors are flipped between the parent and children. You'll learn later why this is a desirable thing to do.

If you try to flip the root, it will remain black, so as not to violate Rule 2, but its children will change from red to black.

The RoL Button

This button carries out a left rotation. To rotate a group of nodes, first single-click the mouse to position the arrow at the topmost node of the group to be rotated. For a left rotation, the top node must have a right child. Then click the button. We'll examine rotations in detail later.

The RoR Button

This button performs a right rotation. Position the arrow on the top node to be rotated, making sure it has a left child; then click the button.

The R/B Button

The R/B button changes a red node to black, or a black node to red. Single-click the mouse to position the red arrow on the node, and then push the button. (This button changes the color of a single node; don't confuse it with the Flip button, which changes three nodes at once.)

Text Messages

Messages in the text box below the buttons tell you whether the tree is *red-black correct*. The tree is red-black correct if it adheres to rules 1 to 4 listed previously. If it's not correct, you'll see messages advising which rule is being violated. In some cases the red arrow will point to where the violation occurred.

Where's the Find Button?

In red-black trees, a search routine operates exactly as it did in the ordinary binary search trees described in the [last chapter](#). It starts at the root, and, at each node it encounters (the current node), it decides whether to go to the left or right child by comparing the key of the current node with the search key.

We don't include a Find button in the RBTree applet because you already understand this process and our attention will be on manipulating the red-black aspects of the tree.

Experimenting

Now that you're familiar with the RBTree buttons, let's do some simple experiments to get a feel for what the applet does. The idea here is to learn to manipulate the applet's controls. Later you'll use these skills to balance the tree.

Experiment 1

Press Start to clear any extra nodes. You'll be left with the root node, which always has

the value 50.

Insert a new node with a value smaller than the root, say 25, by typing the number into the Number box and pressing the Ins button. This doesn't cause any rule violations, so the message continues to say `Tree is red-black correct`.

Insert a second node that's larger than the root, say 75. The tree is still red-black correct. It's also balanced; there are the same number of nodes on the right of the only non-leaf node (the root) as there are on its left. The result is shown in Figure 9.4.

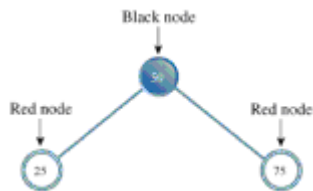

Figure 9.4: A balanced tree

Notice that newly inserted nodes are always colored red (except for the root). This is not an accident. It's less likely that inserting a red node will violate the red-black rules than inserting a black one.

This is because if the new red node is attached to a black one, no rule is broken. It doesn't create a situation in which there are two red nodes together (Rule 3), and it doesn't change the black height in any of the paths (Rule 4). Of course, if you attach a new red node to a red node, Rule 3 will be violated. However, with any luck this will only happen half the time. Whereas, if it were possible to add a new black node, it would always change the black height for its path, violating Rule 4.

Also, it's easier to fix violations of Rule 3 (parent and child are both red) than Rule 4 (black heights differ), as we'll see later.

Experiment 2

Let's try some rotations. Start with the three nodes as shown in Figure 9.4. Position the red arrow on the root (50) by clicking it with the mouse. This node will be the *top node* in the rotation. Now perform a right rotation by pressing the RoR button. The nodes all shift to new positions, as shown in Figure 9.5.

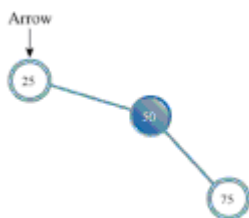

Figure 9.5: Following a right rotation

In this right rotation, the parent or top node moves into the place of its right child, the left child moves up and takes the place of the parent, and the right child moves down to become the grandchild of the new top node.

Notice that the tree is now unbalanced; there are more nodes to the right of the root than to the left. Also, the message indicates that the red-black rules are violated, specifically

Rule 2 (the root is always black). Don't worry about this yet.

Instead, rotate the other way. Position the red arrow on 25, which is now the root (the arrow should already point to 25 after the previous rotation). Click the RoL button to rotate left. The nodes will return to the position of Figure 9.4.

Experiment 3

Start with the position of [Figure 9.4](#), with nodes 25 and 75 inserted in addition to 50 in the root position. Note that the parent (the root) is black and both its children are red. Now try to insert another node. No matter what value you use, you'll see the message `Can't Insert: Needs color flip`.

As we mentioned, a color flip is necessary whenever, during the insertion process, a black node with two red children is encountered.

The red arrow should already be positioned on the black parent (the root node), so click the Flip button. The root's two children change from red to black. Ordinarily the parent would change from black to red, but this is a special case because it's the root: it remains black to avoid violating Rule 2. Now all three nodes are black. The tree is still red-black correct.

Now click the Ins button again to insert the new node. Figure 9.6 shows the result if the newly inserted node has the key value 12.

The tree is still red-black correct. The root is black, there's no situation in which a parent and child are both red, and all the paths have the same number of black nodes (2). Adding the new red node didn't change the red-black correctness.

Experiment 4

Now let's see what happens when you try to do something that leads to an unbalanced tree. In Figure 9.6 one path has one more node than the other. This isn't very unbalanced, and no red-black rules are violated, so neither we nor the red-black algorithms need to worry about it. However, suppose that one path differs from another by two or more levels (where level is the same as the number of nodes along the path). In this case the red-black rules will always be violated, and we'll need to rebalance the tree.

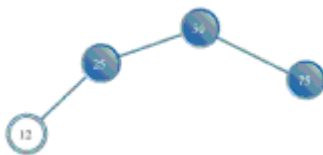

Figure 9.6: Colors flipped, new node inserted

Insert a 6 into the tree of Figure 9.6. You'll see the message `Error: parent and child are both red`. Rule 3 has been violated, as shown in Figure 9.7.

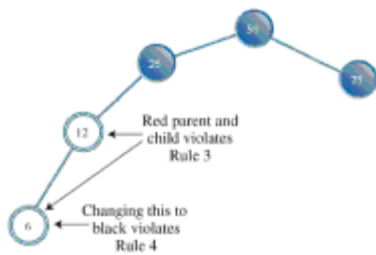

Figure 9.7: Parent and child are both red

How can we fix things so Rule 3 isn't violated? An obvious approach is to change one of the offending nodes to black. Let's try changing the child node, 6. Position the red arrow on it and press the R/B button. The node becomes black.

The good news is we fixed the problem of both parent and child being red. The bad news is that now the message says `Error: Black heights differ`. The path from the root to node 6 has three black nodes in it, while the path from the root to node 75 has only two. Thus Rule 4 is violated. It seems we can't win.

This problem can be fixed with a rotation and some color changes. How to do this will be the topic of later sections.

More Experiments

Experiment with the RBTree Workshop applet on your own. Insert more nodes and see what happens. See if you can use rotations and color changes to achieve a balanced tree. Does keeping the tree red-black correct seem to guarantee an (almost) balanced tree?

Try inserting ascending keys (50, 60, 70, 80, 90) and then restart with the Start button and try descending keys (50, 40, 30, 20, 10). Ignore the messages; we'll see what they mean later. These are the situations that get the ordinary binary search tree into trouble. Can you still balance the tree?

The Red-Black Rules and Balanced Trees

Try to create a tree that is unbalanced by two or more levels but is red-black correct. As it turns out, this is impossible. That's why the red-black rules keep the tree balanced. If one path is more than one node longer than another, then it must either have more black nodes, violating Rule 4, or it must have two adjacent red nodes, violating Rule 3. Convince yourself that this is true by experimenting with the applet.

Null Children

Remember that Rule 4 specifies all paths that go from the root to any leaf or to *any null children* must have the same number of black nodes. A null child is a child that a non-leaf node might have, but doesn't. Thus in Figure 9.8 the path from 50 to 25 to the right child of 25 (its null child) has only one black node, which is not the same as the paths to 6 and 75, which have 2. This arrangement violates Rule 4, although both paths to leaf nodes have the same number of black nodes.

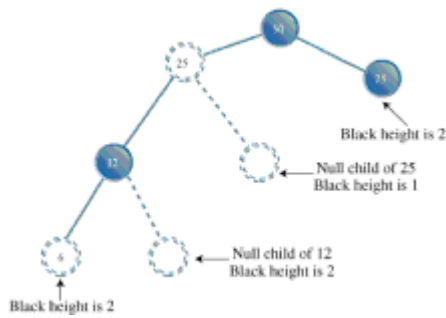

Figure 9.8: Path to a null child

The term *black height* is used to describe the number of black nodes from between a given node and the root. In Figure 9.8 the black height of 50 is 1, of 25 is still 1, of 12 is 2, and so on.

Rotations

To balance a tree, it's necessary to physically rearrange the nodes. If all the nodes are on the left of the root, for example, you need to move some of them over to the right side. This is done using *rotations*. In this section we'll learn what rotations are and how to execute them.

Rotations are ways to rearrange nodes. They were designed to do the following two things:

- Raise some nodes and lower others to help balance the tree.
- Ensure that the characteristics of a binary search tree are not violated.

Recall that in a binary search tree the left children of any node have key values less than the node, while its right children have key values greater or equal to the node. If the rotation didn't maintain a valid binary search tree it wouldn't be of much use, because the search algorithm, as we saw in the [last chapter](#), relies on the search-tree arrangement.

Note that color rules and node color changes are used only to help decide when to perform a rotation; fiddling with the colors doesn't accomplish anything by itself; it's the rotation that's the heavy hitter. Color rules are like rules of thumb for building a house (such as "exterior doors open inward"), while rotations are like the hammering and sawing needed to actually build it.

Simple Rotations

In Experiment 2 we tried rotations to the left and right. These rotations were easy to visualize because they involved only three nodes. Let's clarify some aspects of this process.

What's Rotating?

The term *rotation* can be a little misleading. The nodes themselves aren't rotated, the relationship between them changes. One node is chosen as the "top" of the rotation. If we're doing a right rotation, this "top" node will move down and to the right, into the position of its right child. Its left child will move up to take its place.

Remember that the top node isn't the "center" of the rotation. If we talk about a car tire, the top node doesn't correspond to the axle or the hubcap, it's more like the topmost part

of the tire tread.

The rotation we described in Experiment 2 was performed with the root as the top node, but of course any node can be the top node in a rotation, provided it has the appropriate child.

Mind the Children

You must be sure that, if you're doing a right rotation, the top node has a left child. Otherwise there's nothing to rotate into the top spot. Similarly, if you're doing a left rotation, the top node must have a right child.

The Weird Crossover Node

Rotations can be more complicated than the three-node example we've discussed so far. Click Start, and then, with 50 already at the root, insert nodes with following values, in this order: 25, 75, 12, 37.

When you try to insert the 12, you'll see the `Can't insert: needs color flip` message. Just click the Flip button. The parent and children change color. Then press Ins again to complete the insertion of the 12. Finally insert the 37. The resulting arrangement is shown in Figure 9.9a.

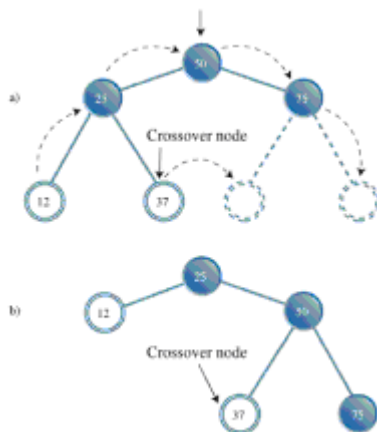

FIGURE 9.9: Rotation with crossover node

Now we'll try a rotation. Place the arrow on the root (don't forget this!) and press the RoR button. All the nodes move. The 12 follows the 25 up, and the 50 follows the 75 down.

But what's this? The 37 has detached itself from the 25, whose right child it was, and become instead the left child of 50. Some nodes go up, some nodes go down, but the 37 moves *across*. The result is shown in Figure 9.9b. The rotation has caused a violation of Rule 4; we'll see how to fix this later.

In the original position of Figure 9.9a, the 37 is called an *inside grandchild* of the top node, 50. (The 12 is an *outside grandchild*.) The inside grandchild, if it's the child of the node that's going up (which is the left child of the top node in a right rotation) is always disconnected from its parent and reconnected to its former grandparent. It's like becoming your own uncle (although it's best not to dwell too long on this analogy).

Subtrees on the Move

We've shown individual nodes changing position during a rotation, but entire subtrees can move as well. To see this, click Start to put 50 at the root, and then insert the

following sequence of nodes in order: 25, 75, 12, 37, 62, 87, 6, 18, 31, 43. Click Flip whenever you can't complete an insertion because of the `Can't insert: needs color flip` message. The resulting arrangement is shown in Figure 9.10a.

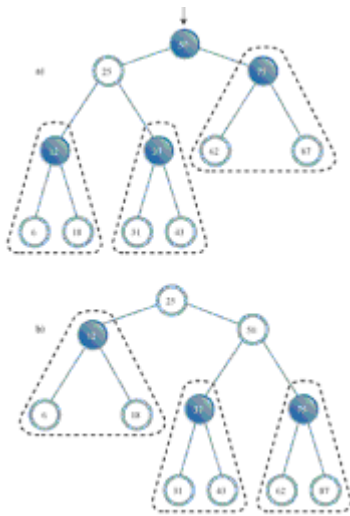

Figure 9.10: Subtree motion during rotation

Position the arrow on the root, 50. Now press RoR. Wow! (Or is it WoW?) A lot of nodes have changed position. The result is shown in Figure 9.10b. Here's what happens:

- The top node (50) goes to its right child.
- The top node's left child (25) goes to the top.
- The entire subtree of which 12 is the root moves up.
- The entire subtree of which 37 is the root moves across to become the left child of 50.
- The entire subtree of which 75 is the root moves down.

You'll see the `Error: root must be black` message but you can ignore it for the time being. You can flip back and forth by alternately pressing RoR and RoL with the arrow on the top node. Do this and watch what happens to the subtrees, especially the one with 37 as its root.

The figures show the subtrees encircled by dotted triangles. Note that the relations of the nodes within each subtree are unaffected by the rotation. The entire subtree moves as a unit. The subtrees can be larger (have more descendants) than the three nodes we show in this example. No matter how many nodes there are in a subtree, they will all move together during a rotation.

Human Beings Versus Computers

This is pretty much all you need to know about what a rotation does. To cause a rotation, you position the arrow on the top node, then press RoR or RoL. Of course, in a real red-black tree insertion algorithm, rotations happen under program control, without human intervention.

Notice however that, in your capacity as a human being, you could probably balance any tree just by looking at it and performing appropriate rotations. Whenever a node has a lot of left descendants and not too many right ones, you rotate it right, and vice versa.

Unfortunately, computers aren't very good at "just looking" at a pattern. They work better if they can follow a few simple rules. That's what the red-black scheme provides, in the form of color coding and the four color rules.

Inserting a New Node

Now you have enough background to see how a red-black tree's insertion routine uses rotations and the color rules to maintain the tree's balance.

Preview

We're going to briefly preview our approach to describing the insertion process. Don't worry if things aren't completely clear in the preview; we'll discuss things in more detail in a moment.

In the discussion that follows we'll use X, P, and G to designate a pattern of related nodes. X is a node that has caused a rule violation. (Sometimes X refers to a newly inserted node, and sometimes to the child node when a parent and child have a red-red conflict.)

- X is a particular node.
- P is the parent of X.
- G is the grandparent of X (the parent of P).

On the way down the tree to find the insertion point, you perform a color flip whenever you find a black node with two red children (a violation of Rule 2). Sometimes the flip causes a red-red conflict (a violation of Rule 3). Call the red child X and the red parent P. The conflict can be fixed with a single rotation or a double rotation, depending on whether X is an outside or inside grandchild of G. Following color flips and rotations, you continue down to the insertion point and insert the new node.

After you've inserted the new node X, if P is black you simply attach the new red node. If P is red, there are two possibilities: X can be an outside or inside grandchild of G. You perform two color changes (we'll see what they are in a moment). If X is an outside grandchild, you perform one rotation, and if it's an inside grandchild you perform two. This restores the tree to a balanced state.

Now we'll recapitulate this preview in more detail. We'll divide the discussion into three parts, arranged in order of complexity:

1. Color flips on the way down
2. Rotations once the node is inserted
3. Rotations on the way down

If we were discussing these three parts in strict chronological order, we'd examine part 3 before part 2. However, it's easier to talk about rotations at the bottom of the tree than in the middle, and operations 1 and 2 are encountered more frequently than operation 3, so we'll discuss 2 before 3.

Color Flips on the Way Down

The insertion routine in a red-black tree starts off doing essentially the same thing it does

in an ordinary binary search tree: It follows a path from the root to the place where the node should be inserted, going left or right at each node depending on the relative size of the node's key and the search key.

However, in a red-black tree, getting to the insertion point is complicated by color flips and rotations. We introduced color flips in Experiment 3; now we'll look at them in more detail.

Imagine the insertion routine proceeding down the tree, going left or right at each node, searching for the place to insert a new node. To make sure the color rules aren't broken, it needs to perform color flips when necessary. Here's the rule: Every time the insertion routine encounters a black node that has two red children, it must change the children to black and the parent to red (unless the parent is the root, which always remains black).

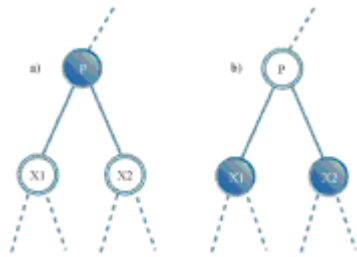

Figure 9.11: Color flip

How does a color flip affect the red-black rules? For convenience, let's call the node at the top of the triangle, the one that's red before the flip, P for parent. We'll call P's left and right children X1 and X2. This is shown in Figure 9.11a.

Black Heights Unchanged

Figure 9.11b shows the nodes after the color flip. The flip leaves unchanged the number of black nodes on the path from the root on down through P to the leaf or null nodes. All such paths go through P, and then through either X1 or X2. Before the flip, only P is black, so the triangle (consisting of P, X1, and X2) adds one black node to each of these paths.

After the flip, P is no longer black, but both L and R are, so again the triangle contributes one black node to every path that passes through it. So a color flip can't cause Rule 4 to be violated.

Color flips are helpful because they make red leaf nodes into black leaf nodes. This makes it easier to attach new red nodes without violating Rule 3.

Could Be Two Reds

Although Rule 4 is not violated by a color flip, Rule 3 (a node and its parent can't both be red) may be. If the parent of P is black, there's no problem when P is changed from black to red. However, if the parent of P is red, then, after the color change, we'll have two reds in a row.

This needs to be fixed before we continue down the path to insert the new node. We can correct the situation with a rotation, as we'll soon see.

The Root Situation

What about the root? Remember that a color flip of the root and its two children leaves the root, as well as its children, black. This avoids violating Rule 2. Does this affect the

other red-black rules? Clearly there are no red-to-red conflicts, because we've made more nodes black and none red. Thus, Rule 3 isn't violated. Also, because the root and one or the other of its two children are in every path, the black height of every path is increased the same amount; that is, by 1. Thus, Rule 4 isn't violated either.

Finally, Just Insert It

Once you've worked your way down to the appropriate place in the tree, performing color flips (and rotations) if necessary on the way down, you can then insert the new node as described in the [last chapter](#) for an ordinary binary search tree. However, that's not the end of the story.

Rotations Once the Node is Inserted

The insertion of the new node may cause the red-black rules to be violated. Therefore, following the insertion, we must check for rule violations and take appropriate steps.

Remember that, as described earlier, the newly inserted node, which we'll call X, is always red. X may be located in various positions relative to P and G, as shown in Figure 9.12.

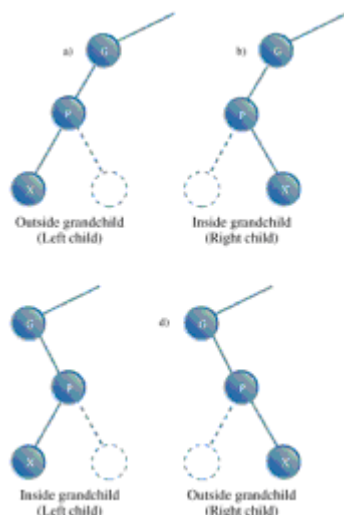

Figure 9.12: Handed variations of node being inserted

Remember that a node X is an outside grandchild if it's on the same side of its parent P that P is of its parent G. That is, X is an outside grandchild if either it's a left child of P and P is a left child of G, or it's a right child of P and P is a right child of G. Conversely, X is an inside grandchild if it's on the opposite side of its parent P that P is of its parent G.

If X is an outside grandchild, it may be either the left or right child of P, depending on whether P is the left or right child of G. Two similar possibilities exist if X is an inside grandchild. It's these four situations that are shown in Figure 9.12. This multiplicity of what we might call "handed" (left or right) variations is one reason the red-black insertion routine is challenging to program.

The action we take to restore the red-black rules is determined by the colors and configuration of X and its relatives. Perhaps surprisingly, there are only three major ways in which nodes can be arranged (not counting the handed variations already mentioned). Each possibility must be dealt with in a different way to preserve red-black correctness and thereby lead to a balanced tree. We'll list the three possibilities briefly, then discuss each one in detail in its own section. Figure 9.13 shows what they look like. Remember that X is always red.

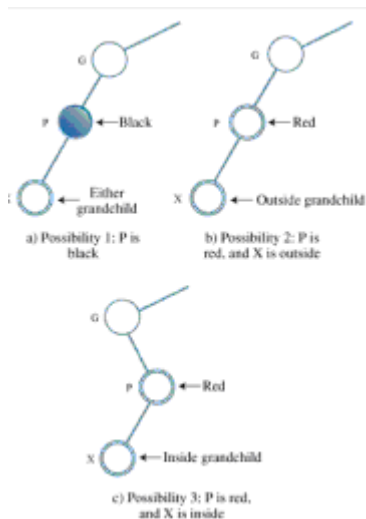

Figure 9.13: Three post-insertion possibilities

1. P is black.
2. P is red and X is an outside grandchild of G.
3. P is red and X is an inside grandchild of G.

It might seem that this list doesn't cover all the possibilities. We'll return to this question after we've explored these three.

Possibility 1: P Is Black

If P is black, we get a free ride. The node we've just inserted is always red. If its parent is black, there's no red-to-red conflict (Rule 3), and no addition to the number of black nodes (Rule 4). Thus no color rules are violated. We don't need to do anything else. The insertion is complete.

Possibility 2: P Is Red, X Is Outside

If P is red and X is an outside grandchild, we need a single rotation and some color changes. Let's set this up with the Workshop applet so we can see what we're talking about. Start with the usual 50 at the root, and insert 25, 75, and 12. You'll need to do a color flip before you insert the 12.

Now insert 6, which is X, the new node. Figure 9.14a shows how this looks. The message on the Workshop applet says `Error: parent and child both red`, so we know we need to take some action.

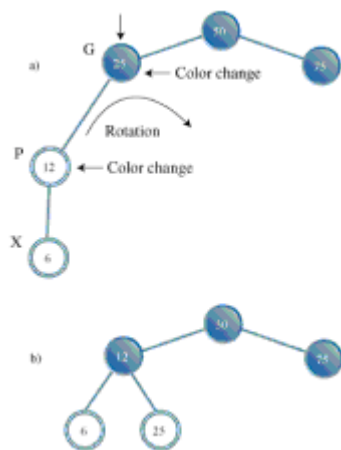

Figure 9.14: P is red, X is an outside grandchild

In this situation, we can take three steps to restore red-black correctness and thereby balance the tree. Here are the steps:

1. Switch the color of X's grandparent G (25 in this example).
2. Switch the color of X's parent P (12).
3. Rotate with X's grandparent G (25) at the top, in the direction that raises X (6). This is a right rotation in the example.

As you've learned, to switch colors, put the arrow on the node and press the R/B button. To rotate right, put the arrow on the top node and press RoR. When you've completed the three steps, the Workshop applet will inform you that the `Tree is red/black correct`. It's also more balanced than it was, as shown in Figure 9.14b.

In this example, X was an outside grandchild and a left child. There's a symmetrical situation when the X is an outside grandchild but a right child. Try this by creating the tree 50, 25, 75, 87, 93 (with color flips when necessary). Fix it by changing the colors of 75 and 87, and rotating left with 75 at the top. Again the tree is balanced.

Possibility 3: P Is Red and X Is Inside

If P is red and X is an inside grandchild, we need two rotations and some color changes. To see this one in action, use the Workshop applet to create the tree 50, 25, 75, 12, 18. (Again you'll need a color flip before you insert the 12.) The result is shown in Figure 9.15a.

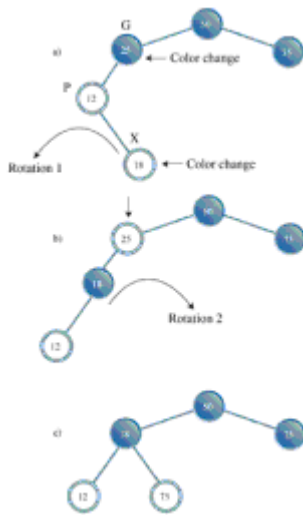

Figure 9.15: Possibility 3: P is red and X is an inside grandchild

Note that the 18 node is an inside grandchild. It and its parent are both red, so again you see the error message `Error: parent and child both red.`

Fixing this arrangement is slightly more complicated. If we try to rotate right with the grandparent node G (25) at the top, as we did in Possibility 2, the inside grandchild X (18) moves across rather than up, so the tree is no more balanced than before. (Try this, then rotate back, with 12 at the top, to restore it.) A different solution is needed.

The trick when X is an inside grandchild is to perform *two* rotations rather than one. The first changes X from an inside grandchild to an outside grandchild, as shown in Figure 9.15b. Now the situation is similar to Possibility 1, and we can apply the same rotation, with the grandparent at the top, as we did before. The result is shown in Figure 9.15c.

We must also recolor the nodes. We do this before doing any rotations. (This order doesn't really matter, but if we wait until after the rotations to recolor the nodes, it's hard to know what to call them.) The steps are

1. Switch the color of X's grandparent (25 in this example).
2. Switch the color of X (*not* its parent; X is 18 here).
3. Rotate with X's parent P at the top (*not* the grandparent; the parent is 12), in the direction that raises X (a left rotation in this example).
4. Rotate again with X's grandparent (25) at the top, in the direction that raises X (a right rotation).

This restores the tree to red-black correctness and also balances it (as much as possible). As with Possibility 2, there is an analogous case in which P is the right child of G rather than the left.

What About Other Possibilities?

Do the three Post-Insertion Possibilities we just discussed really cover all situations?

Suppose, for example, that X has a sibling S; the other child of P. This might complicate the rotations necessary to insert X. But if P is black, there's no problem inserting X (that's Possibility 1). If P is red, then both its children must be black (to avoid violating Rule 3). It

can't have a single child S that's black, because the black heights would be different for S and the null child. However, we know X is red, so we conclude that it's impossible for X to have a sibling unless P is red.

Another possibility is that G, the grandparent of P, has a child U, the sibling of P and the uncle of X. Again, this would complicate any necessary rotations. However, if P is black, there's no need for rotations when inserting X, as we've seen. So let's assume P is red. Then U must also be red, otherwise the black height going from G to P would be different from that going from G to U. But a black parent with two red children is flipped on the way down, so this situation can't exist either.

Thus the three possibilities discussed above are the only ones that can exist (except that, in Possibilities 2 and 3, X can be a right or left child and G can be a right or left child).

What the Color Flips Accomplished

Suppose that performing a rotation and appropriate color changes caused other violations of the red-black rules to appear further up the tree. One can imagine situations in which you would need to work your way all the way back up the tree, performing rotations and color switches, to remove rule violations.

Fortunately, this situation can't arise. Using color flips on the way down has eliminated the situations in which a rotation could introduce any rule violations further up the tree. It ensures that one or two rotations will restore red-black correctness in the entire tree. Actually proving this is beyond the scope of this book, but such a proof is possible.

It's the color flips on the way down that make insertion in red-black trees more efficient than in other kinds of balanced trees, such as AVL trees. They ensure that you need to pass through the tree only once, on the way down.

Rotations on the Way Down

Now we'll discuss the last of the three operations involved in inserting a node: making rotations on the way down to the insertion point. As we noted, although we're discussing this last, it actually takes place before the node is inserted. We've waited until now to discuss it only because it was easier to explain rotations for a just-installed node than for nodes in the middle of the tree.

During the discussion of color flips during the insertion process, we noted that it's possible for a color flip to cause a violation of Rule 3 (a parent and child can't both be red). We also noted that a rotation can fix this violation.

There are two possibilities, corresponding to Possibility 2 and Possibility 3 during the insertion phase described above. The offending node can be an outside grandchild or it can be an inside grandchild. (In the situation corresponding to Possibility 1, no action is required.)

Outside Grandchild

First we'll examine an example in which the offending node is an outside grandchild. By "offending node" we mean the child in the parent-child pair that caused the red-red conflict.

Start a new tree with the 50 node, and insert the following nodes: 25, 75, 12, 37, 6, and 18. You'll need to do color flips when inserting 12 and 6.

Now try to insert a node with the value 3. You'll be told you must flip 12 and its children 6 and 18. You push the Flip button. The flip is carried out, but now the message says `Error: parent and child are both red, referring to 25 and its child 12`. The

resulting tree is shown in Figure 9.16a.

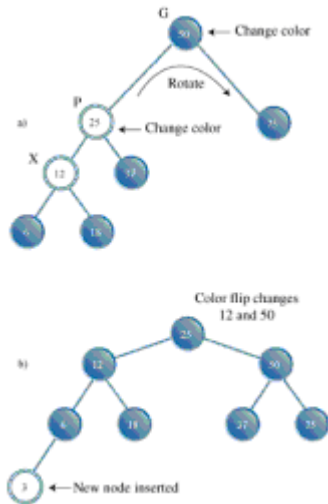

Figure 9.16: Outside grandchild on the way down

The procedure used to fix this is similar to the post-insertion operation with an outside grandchild, described earlier. We must perform two color switches and one rotation. So we can discuss this in the same terms we did when inserting a node, we'll call the node at the top of the triangle that was flipped (which is 12 in this case) X. This looks a little odd, because we're used to thinking of X as the node being inserted, and here it's not even a leaf node. However, these on-the-way-down rotations can take place anywhere within the tree.

The parent of X is P (25 in this case), and the grandparent of X—the parent of P—is G (50 in this case). We follow the same set of rules we did under Possibility 2, discussed above.

1. Switch the color of X's grandparent G (50 in this example). Ignore the message that the root must be black.
2. Switch the color of X's parent P (25).
3. Rotate with X's grandparent (50) at the top, in the direction that raises X (here a right rotation).

Suddenly, the tree is balanced! It has also become pleasantly symmetrical. It appears to be a bit of a miracle, but it's only a result of following the color rules.

Now the node with value 3 can be inserted in the usual way. Because the node it connects to, 6, is black, there's no complexity about the insertion. One color flip (at 50) is necessary. Figure 9.16b shows the tree after 3 is inserted.

Inside Grandchild

If X is an inside grandchild when a red-red conflict occurs on the way down, two rotations are required to set it right. This situation is similar to the inside grandchild in the post-insertion phase, which we called Possibility 3.

Click Start in the RBTree Workshop applet to begin with 50, and insert 25, 75, 12, 37, 31, and 43. You'll need color flips before 12 and 31.

Now try to insert a new node with the value 28. You'll be told it needs a color flip (at 37). But when you perform the flip, 37 and 25 are both red, and you get the `Error: parent and child are both red` message. Don't press Ins again.

In this situation G is 50, P is 25, and X is 37, as shown in Figure 9.17a

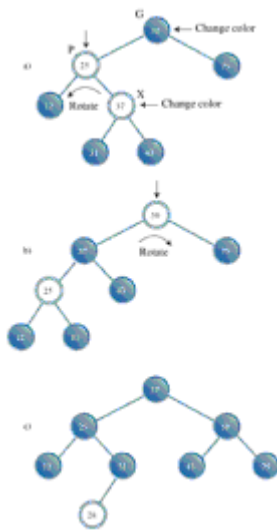

Figure 9.17: Inside grandchild on the way down

To cure the red-red conflict, you must do the same two color changes and two rotations as in Possibility 3.

1. Change the color of G (it's 50; ignore the message that the root must be black).
2. Change the color of X (37).
3. Rotate with P (25) as the top, in the direction that raises X (left in this example). The result is shown in Figure 9.17b.
4. Rotate with G as the top, in the direction that raises X (right in this example).

Now you can insert the 28. A color flip changes 25 and 50 to black as you insert it. The result is shown in Figure 9.17c.

This concludes the description of how a tree is kept red-black correct, and therefore balanced, during the insertion process.

Deletion

As you may recall, coding for deletion in an ordinary binary search tree is considerably harder than for insertion. The same is true in red-black trees, but in addition, the deletion process is, as you might expect, complicated by the need to restore red-black correctness after the node is removed.

In fact, the deletion process is so complicated that many programmers sidestep it in various ways. One approach, as with ordinary binary trees, is to mark a node as deleted without actually deleting it. A search routine that finds the node then knows not to tell anyone about it. This works in many situations, especially if deletions are not a common occurrence. In any case, we're going to forgo a discussion of the deletion process. You can refer to [Appendix B, "Further Reading,"](#) if you want to pursue it.

The Efficiency of Red-Black Trees

Like ordinary binary search trees, a red-black tree allows for searching, insertion, and deletion in $O(\log_2 N)$ time. Search times should be almost the same in the red-black tree as in the ordinary tree because the red-black characteristics of the tree aren't used during searches. The only penalty is that the storage required for each node is increased slightly to accommodate the red-black color (a boolean variable).

More specifically, according to Sedgwick (see Appendix B), in practice a search in a red-black tree takes about $\log_2 N$ comparisons, and it can be shown that it cannot require more than $2 \cdot \log_2 N$ comparisons.

The times for insertion and deletion are increased by a constant factor because of having to perform color flips and rotations on the way down and at the insertion point. On the average, an insertion requires about one rotation. Therefore, insertion still takes $O(\log_2 N)$ time, but is slower than insertion in the ordinary binary tree.

Because in most applications there will be more searches than insertions and deletions, there is probably not much overall time penalty for using a red-black tree instead of an ordinary tree. Of course, the advantage is that in a red-black tree sorted data doesn't lead to slow $O(N)$ performance.

Implementation

If you're writing an insertion routine for red-black trees, all you need to do (irony intended) is to write code to carry out the operations described above. As we noted, showing and describing such code is beyond the scope of this book. However, here's what you'll need to think about.

You'll need to add a red-black field (which can be type boolean) to the `Node` class.

You can adapt the insertion routine from the `tree.java` program in [Chapter 8](#). On the way down to the insertion point, check whether the current node is black and its two children are both red. If so, change the color of all three (unless the parent is the root, which must be kept black).

After a color flip, check that there are no violations of Rule 3. If so, perform the appropriate rotations: one for an outside grandchild, two for an inside grandchild.

When you reach a leaf node, insert the new node as in `tree.java`, making sure the node is red. Check again for red-red conflicts, and perform any necessary rotations.

Perhaps surprisingly, your software need not keep track of the black height of different parts of the tree (although you might want to check this during debugging). You only need to check for violations of Rule 3, a red parent with a red child, which can be done locally (unlike checks of black heights, Rule 4, which would require more complex bookkeeping).

If you perform the color flips, color changes, and rotations described earlier, the black heights of the nodes should take care of themselves and the tree should remain balanced. The `RBTree Workshop` applet reports black-height errors only because the user is not forced to carry out insertion algorithm correctly.

Other Balanced Trees

The *AVL tree* is the earliest kind of balanced tree. It's named after its inventors: Adelson-Velskii and Landis. In AVL trees each node stores an additional piece of data: the difference between the heights of its left and right subtrees. This difference may not be

larger than 1. That is, the height of a node's left subtree may be no more than one level different from the height of its right subtree.

Following insertion, the root of the lowest subtree into which the new node was inserted is checked. If the height of its children differs by more than 1, a single or double rotation is performed to equalize their heights. The algorithm then moves up and checks the node above, equalizing heights if necessary. This continues all the way back up to the root.

Search times in an AVL tree are $O(\log N)$ because the tree is guaranteed to be balanced. However, because two passes through the tree are necessary to insert (or delete) a node, one down to find the insertion point and one up to rebalance the tree, AVL trees are not as efficient as red-black trees and are not used as often.

The other important kind of balanced tree is the *multiway tree*, in which each node can have more than two children. We'll look at one version of multiway trees, the 2-3-4 tree, in the [next chapter](#). One problem with multiway trees is that each node must be larger than for a binary tree, because it needs a reference to every one of its children.

Summary

- It's important to keep a binary search tree balanced to ensure that the time necessary to find a given node is kept as short as possible.
- Inserting data that has already been sorted can create a maximally unbalanced tree, which will have search times of $O(N)$.
- In the red-black balancing scheme, each node is given a new characteristic: a color that can be either red or black.
- A set of rules, called red-black rules, specifies permissible ways that nodes of different colors can be arranged.
- These rules are applied while inserting (or deleting) a node.
- A color flip changes a black node with two red children to a red node with two black children.
- In a rotation, one node is designated the top node.
- A right rotation moves the top node into the position of its right child, and the top node's left child into its position.
- A left rotation moves the top node into the position of its left child, and the top node's right child into its position.
- Color flips, and sometimes rotations, are applied while searching down the tree to find where a new node should be inserted. These flips simplify returning the tree to red-black correctness following an insertion.
- After a new node is inserted, red-red conflicts are checked again. If a violation is found, appropriate rotations are carried out to make the tree red-black correct.
- These adjustments result in the tree being balanced, or at least almost balanced.
- Adding red-black balancing to a binary tree has only a small negative effect on average performance, and avoids worst-case performance when the data is already sorted.

Part IV

Chapter List

Chapter 10: 2-3-4 Trees and External Storage

Chapter 11: Hash Tables

Chapter 12: Heaps

Chapter 10: 2-3-4 Trees and External Storage

Overview

In a binary tree, each node has one data item and can have up to two children. If we allow more data items and children per node, the result is a *multiway tree*. 2-3-4 trees, to which we devote the first part of this chapter, are multiway trees that can have up to four children and three data items per node.

2-3-4 trees are interesting for several reasons. First, they're balanced trees like red-black trees. They're slightly less efficient than red-black trees, but easier to program. Second, and most importantly, they serve as an easy-to-understand introduction to B-trees.

A B-tree is another kind of multiway tree that's particularly useful for organizing data in external storage. (*External* means external to main memory; usually this is a disk drive.) A node in a B-tree can have dozens or hundreds of children. We'll discuss external storage and B-trees in the second part of this chapter.

Introduction to 2-3-4 Trees

In this section we'll look at the characteristics of 2-3-4 trees. Later we'll see how a Workshop applet models a 2-3-4 tree, and how we can program a 2-3-4 tree in Java. We'll also look at the surprisingly close relationship between 2-3-4 trees and red-black trees.

Figure 10.1 shows a small 2-3-4 tree. Each lozenge-shaped node can hold one, two, or three data items.

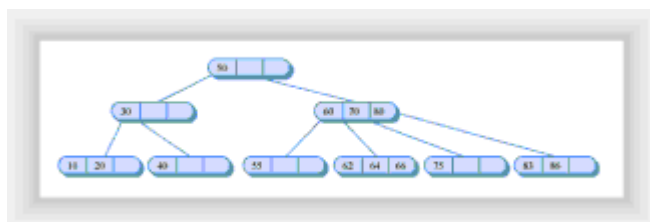

Figure 10.1: A 2-3-4 tree

Here the top three nodes have children, and the six nodes on the bottom row are all leaf nodes, which by definition have no children. In a 2-3-4 tree all the leaf nodes are always on the same level.

What's in a Name?

The 2, 3, and 4 in the name 2-3-4 tree refer to how many links to child nodes can potentially be contained in a given node. For non-leaf nodes, three arrangements are possible:

- A node with one data item always has two children
- A node with two data items always has three children
- A node with three data items always has four children

In short, a non-leaf node must always have one more child than it has data items. Or, to put it symbolically, if the number of child links is L and the number of data items is D , then

$$L = D + 1$$

This is a critical relationship that determines the structure of 2-3-4 trees. A leaf node, by contrast, has no children, but it can nevertheless contain one, two, or three data items. Empty nodes are not allowed.

Because a 2-3-4 tree can have nodes with up to four children, it's called a *multiway tree of order 4*.

You may wonder why a 2-3-4 tree isn't called a 1-2-3-4 tree. Can't a node have only one child, as nodes in binary trees can? A binary tree (described in [Chapters 8, "Binary Trees,"](#) and [9, "Red-Black Trees"](#)) can be thought of as a multiway tree of order 2 because each node can have up to two children. However, there's a difference (besides the maximum number of children) between binary trees and 2-3-4 trees. In a binary tree, a node can have *up to* two child links. A single link, to its left or to its right child, is also perfectly permissible. The other link has a null value.

In a 2-3-4 tree, on the other hand, nodes with a single link are not permitted. A node with one data item must always have two links, unless it's a leaf, in which case it has no links.

Figure 10.2 shows the possibilities. A node with two links is called a *2-node*, a node with three links is a *3-node*, and a node with 4 links is a *4-node*, but there is no such thing as a 1-node.

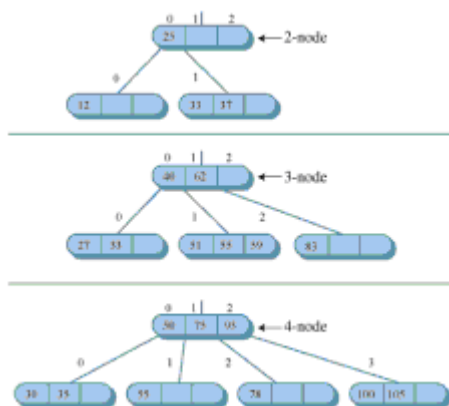

Figure 10.2: Nodes in a 2-3-4 tree

2-3-4 Tree Organization

For convenience we number the data items in a link from 0 to 2, and the child links from 0 to 3, as shown in [Figure 10.2](#). The data items in a node are arranged in ascending key order; by convention from left to right (lower to higher numbers).

An important aspect of any tree's structure is the relationship of its links to the key values of its data items. In a binary tree, all children with keys less than the node's key are in a subtree rooted in the node's left child, and all children with keys larger than or equal to the node's key are rooted in the node's right child. In a 2-3-4 tree the principle is the same, but there's more to it:

- All children in the subtree rooted at child 0 have key values less than key 0.
- All children in the subtree rooted at child 1 have key values greater than key 0 but less than key 1.
- All children in the subtree rooted at child 2 have key values greater than key 1 but less than key 2.
- All children in the subtree rooted at child 3 have key values greater than key 2.

This is shown in [Figure 10.3](#). Duplicate values are not usually permitted in 2-3-4 trees, so we don't need to worry about comparing equal keys.

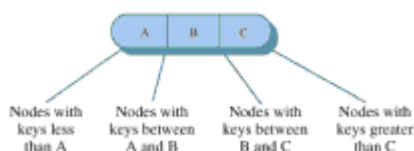

Figure 10.3: Keys and children

Refer to the tree in [Figure 10.1](#). As in all 2-3-4 trees, the leaves are all on the same level (the bottom row). Upper-level nodes are often not full; that is, they may contain only one or two data items instead of three.

Also, notice that the tree is balanced. It retains its balance even if you insert a sequence of data in ascending (or descending) order. The 2-3-4 tree's self-balancing capability results from the way new data items are inserted, as we'll see in a moment.

Searching

Finding a data item with a particular key is similar to the search routine in a binary tree. You start at the root, and, unless the search key is found there, select the link that leads to the subtree with the appropriate range of values.

For example, to search for the data item with key 64 in the tree in [Figure 10.1](#), you start at the root. You search the root, but don't find the item. Because 64 is larger than 50, you go to child 1, which we will represent as 60/70/80. (Remember that child 1 is on the right, because the numbering of children and links starts at 0 on the left.) You don't find the data item in this node either, so you must go to the next child. Here, because 64 is greater than 60 but less than 70, you go again to child 1. This time you find the specified item in the 62/64/66 link.

Insertion

New data items are always inserted in leaves, which are on the bottom row of the tree. If

items were inserted in nodes with children, then the number of children would need to be changed to maintain the structure of the tree, which stipulates that there should be one more child than data items in a node.

Insertion into a 2-3-4 tree is sometimes quite easy and sometimes rather complicated. In any case the process begins by searching for the appropriate leaf node.

If no full nodes are encountered during the search, insertion is easy. When the appropriate leaf node is reached, the new data item is simply inserted into it. Figure 10.4 shows a data item with key 18 being inserted into a 2-3-4 tree.

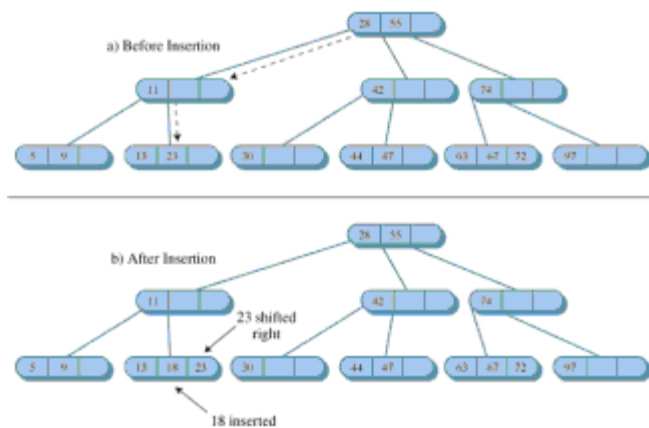

Figure 10.4: Insertion with no splits

Insertion may involve moving one or two other items in a node so the keys will be in the correct order after the new item is inserted. In this example the 23 had to be shifted right to make room for the 18.

Node Splits

Insertion becomes more complicated if a full node is encountered on the path down to the insertion point. When this happens, the node must be *split*. It's this splitting process that keeps the tree balanced. The kind of 2-3-4 tree we're discussing here is often called a *top-down* 2-3-4 tree because nodes are split on the way down to the insertion point.

Let's name the data items in the node that's about to be split A, B, and C. Here's what happens in a split. (We assume the node being split is not the root; we'll examine splitting the root later.)

- A new, empty node is created. It's a sibling of the node being split, and is placed to its right.
- Data item C is moved into the new node.
- Data item B is moved into the parent of the node being split.
- Data item A remains where it is.
- The rightmost two children are disconnected from the node being split and connected to the new node.

An example of a node split is shown in Figure 10.5. Another way of describing a node split is to say that a 4-node has been transformed into two 2-nodes.

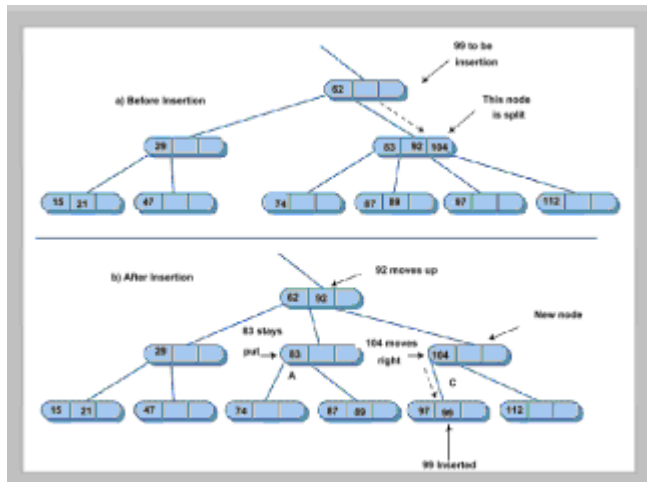

Figure 10.5: Splitting a node

Notice that the effect of the node split is to move data up and to the right. It's this rearrangement that keeps the tree balanced.

Here the insertion required only one node split, but more than one full node may be encountered on the path to the insertion point. When this is the case there will be multiple splits.

Splitting the Root

When a full root is encountered at the beginning of the search for the insertion point, the resulting split is slightly more complicated:

- A new node is created that becomes the new root and the parent of the node being split.
- A second new node is created that becomes a sibling of the node being split.
- Data item C is moved into the new sibling.
- Data item B is moved into the new root.
- Data item A remains where it is.
- The two rightmost children of the node being split are disconnected from it and connected to the new right-hand node.

Figure 10.6 shows the root being split. This process creates a new root that's at a higher level than the old one. Thus the overall height of the tree is increased by one.

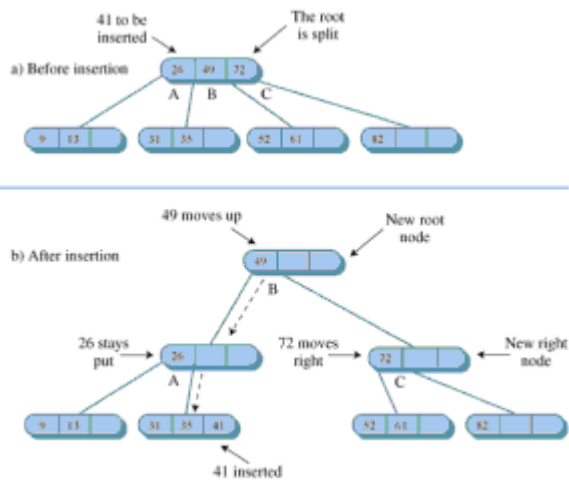

Figure 10.6: Splitting the root

Another way to describe splitting the root is to say that a 4-node is split into three 2-nodes.

Following a node split, the search for the insertion point continues down the tree. In Figure 10.6, the data item with a key of 41 is inserted into the appropriate leaf.

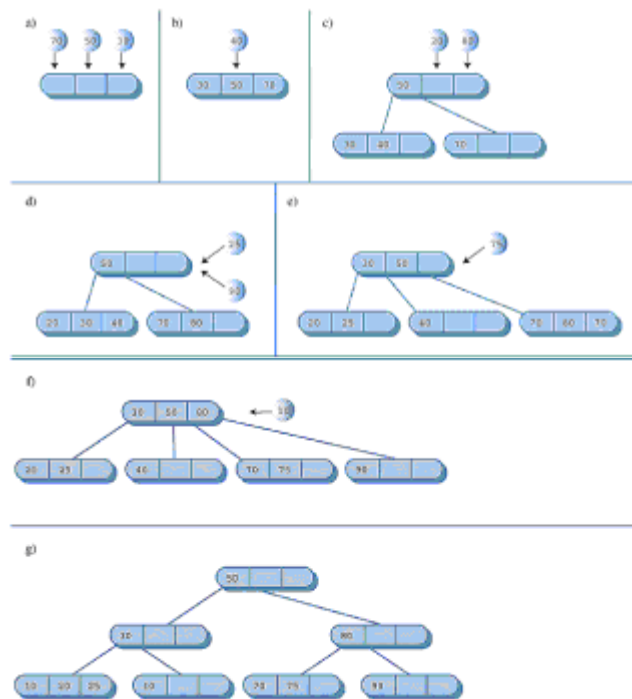

Figure 10.7: Insertions into a 2-3-4 tree

Splitting on the Way Down

Notice that, because all full nodes are split on the way down, a split can't cause an effect that ripples back up through the tree. The parent of any node that's being split is guaranteed not to be full, and can therefore accept data item B without itself needing to be split. Of course, if this parent already had two children when its child was split, it will

become full. However, that just means that it will be split when the next search encounters it.

Figure 10.7 shows a series of insertions into an empty tree. There are four node splits, two of the root and two of leaves.

The Tree234 Workshop Applet

Operating the Tree234 Workshop applet provides a quick way to see how 2-3-4 trees work. When you start the applet you'll see a screen similar to Figure 10.8.

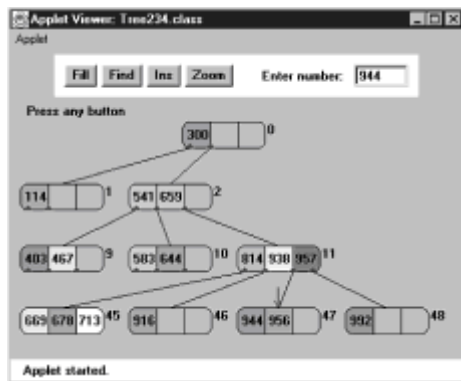

Figure 10.8: The Tree234 Workshop applet

The Fill Button

When it's first started, the Tree234 Workshop applet inserts 10 data items into the tree. You can use the Fill button to create a new tree with a different number of data items from 0 to 45. Click Fill and type the number into the field when prompted. Another click will create the new tree.

The tree may not look very full with 45 nodes, but more nodes require more levels, which won't fit in the display.

The Find Button

You can watch the applet locate a data item with a given key by repeatedly clicking the Find button. When prompted, type in the appropriate key. Then, as you click the button, watch the red arrow move from node to node as it searches for the item.

Messages will say something like `went to child number 1`. As we've seen, children are numbered from 0 to 3 from left to right, while data items are numbered from 0 to 2. After a little practice you should be able to predict the path the search will take.

A search involves examining one node on each level. The applet supports a maximum of four levels, so any item can be found by examining only four nodes. Within each non-leaf node, the algorithm examines each data item, starting on the left, to see which child it should go to next. In a leaf node it examines each data item to see if it contains the specified key. If it can't find such an item in the leaf node, the search fails.

In the Tree234 Workshop applet it's important to complete each operation before attempting a new one. Continue to click the button until the message says `Press any button`. This is the signal that an operation is complete.

The Ins Button

The Ins button causes a new data item, with a key specified in the text box, to be inserted in the tree. The algorithm first searches for the appropriate node. If it encounters a full node along the way, it splits it before continuing on.

Experiment with the insertion process. Watch what happens when there are no full nodes on the path to the insertion point. This is a straightforward process. Then try inserting at the end of a path that includes a full node, either at the root, at the leaf, or somewhere in between. Watch how new nodes are formed and the contents of the node being split are distributed among three different nodes.

The Zoom Button

One of the problems with 2-3-4 trees is that there are a great many nodes and data items just a few levels down. The Tree234 Workshop applet supports only four levels, but there are potentially 64 nodes on the bottom level, each of which can hold up to three data items.

It would be impossible to display so many items at once on one row, so the applet shows only some of them: the children of a selected node. (To see the children of another node, you click on it; we'll discuss that in a moment.) To see a zoomed-out view of the entire tree, click the Zoom button. Figure 10.9 shows what you'll see.

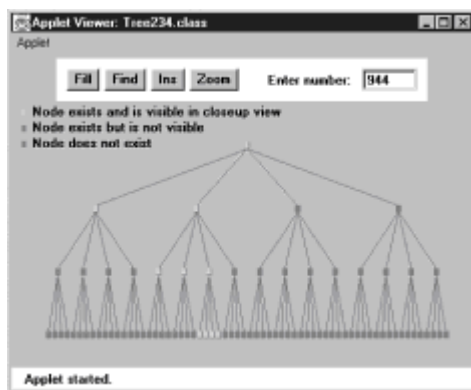

Figure 10.9: The zoomed-out view

In this view nodes are shown as small rectangles; data items are not shown. Nodes that exist and are visible in the zoomed-in view (which you can restore by clicking Zoom again) are shown in green. Nodes that exist but aren't currently visible in the zoomed-out view are shown in magenta, and nodes that don't exist are shown in gray. These colors are hard to distinguish on the figure; you'll need to view the applet on your color monitor to make sense of the display.

Using the Zoom button to toggle back and forth between the zoomed-out and zoomed-in views allows you to see both the big picture and the details, and hopefully put the two together in your mind.

Viewing Different Nodes

In the zoomed-in view you can always see all the nodes in the top two rows: there's only one, the root, in the top row, and only four in the second row. Below the second row things get more complicated because there are too many nodes to fit on the screen: 16 on the third row, 64 on the fourth. However, you can see any node you want by clicking on its parent, or sometimes its grandparent and then its parent.

A blue triangle at the bottom of a node shows where a child is connected to a node. If a

node's children are currently visible, the lines to the children can be seen running from the blue triangles to them. If the children aren't currently visible, there are no lines, but the blue triangles indicate that the node nevertheless has children. If you click on the parent node, its children and the lines to them will appear. By clicking the appropriate nodes you can navigate all over the tree.

For convenience, all the nodes are numbered, starting with 0 at the root and continuing up to 85 for the node on the far right of the bottom row. The numbers are displayed to the upper right of each node, as shown in [Figure 10.8](#). Nodes are numbered whether they exist or not, so the numbers on existing nodes probably won't be contiguous.

Figure 10.10 shows a small tree with four nodes in the third row. The user has clicked on node 1, so its two children, numbered 5 and 6, are visible.

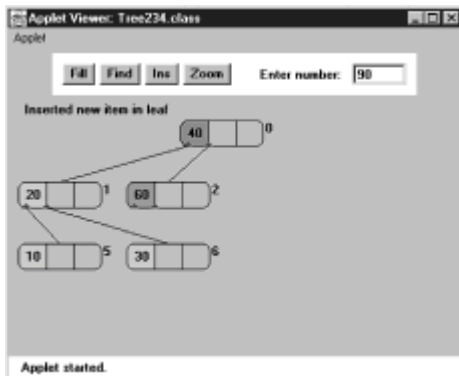

Figure 10.10: Selecting the leftmost children

If the user clicks on node 2, its children 9 and 10 will appear, as shown in Figure 10.11.

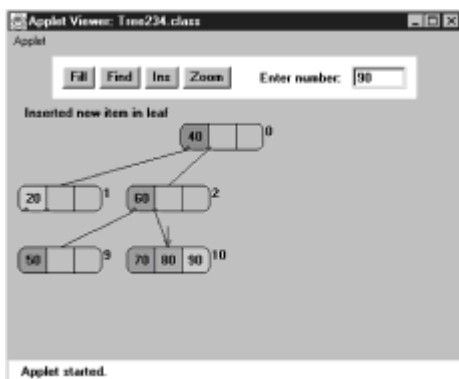

Figure 10.11: Selecting the rightmost children

These figures show how to switch among different nodes in the third row by clicking nodes in the second row. To switch nodes in the fourth row you'll need to click first on a grandparent in the second row, then on a parent in the third row.

During searches and insertions with the Find and Ins buttons, the view will change automatically to show the node currently being pointed to by the red arrow.

Experiments

The Tree234 Workshop applet offers a quick way to learn about 2-3-4 trees. Try inserting items into the tree. Watch for node splits. Stop before one is about to happen, and figure

out where the three data items from the split node are going to go. Then press `Ins` again to see if you're right.

As the tree gets larger you'll need to move around it to see all the nodes. Click on a node to see its children (and their children, and so on). If you lose track of where you are, use the `Zoom` key to see the big picture.

How many data items can you insert in the tree? There's a limit because only four levels are allowed. Four levels can potentially contain $1 + 4 + 16 + 64$ nodes, for a total of 85 nodes (all visible on the zoomed-out display). Assume a full 3 items per node gives 255 data items. However, the nodes can't all be full at the same time. Long before they fill up, another root split, leading to five levels, would be necessary, and this is impossible because the applet supports only four levels.

You can insert the most items by deliberately inserting them into nodes that lie on paths with no full nodes, so that no splits are necessary. Of course this is not a reasonable procedure with real data. For random data you probably can't insert more than about 50 items into the applet. The `Fill` button allows only 45, to minimize the possibility of overflow.

Java Code for a 2-3-4 Tree

In this section we'll examine a Java program that models a 2-3-4 tree. We'll show the complete `tree234.java` program at the end of the section. This is a relatively complex program, and the classes are extensively interrelated, so you'll need to peruse the entire listing to see how it works.

There are four classes: `DataItem`, `Node`, `Tree234`, and `Tree234App`. We'll discuss them in turn.

The `DataItem` Class

Objects of this class represent the data items stored in nodes. In a real-world program each object would contain an entire personnel or inventory record; but here there's only one piece of data, of type `double`, associated with each `DataItem` object.

The only actions that objects of this class can perform are to initialize themselves and display themselves. The display is the data value preceded by a slash: `/27`. (The display routine in the `Node` class will call this routine to display all the items in a node.)

The `Node` Class

The `Node` class contains two arrays: `childArray` and `itemArray`. The first is four cells long and holds references to whatever children the node might have. The second is three cells long and holds references to objects of type `DataItem` contained in the node.

Note that the data items in `itemArray` comprise an ordered array. New items are added, or existing ones removed, in the same way they would be in any ordered array (as described in [Chapter 2, "Arrays"](#)). Items may need to be shifted to make room to insert a new item in order or to close an empty cell when an item is removed.

We've chosen to store the number of items currently in the node (`numItems`) and the node's parent (`parent`) as fields in this class. Neither of these is strictly necessary, and could be eliminated to make the nodes smaller. However, including them clarifies the programming, and only a small price is paid in increased node size.

Various small utility routines are provided in the `Node` class to manage the connections to child and parent and to check if the node is full and if it is a leaf. However, the major work is done by the `findItem()`, `insertItem()`, and `removeItem()` routines. These

handle individual items within the node. They search through the node for a data item with a particular key; insert a new item into the node, moving existing items if necessary; and remove an item, again moving existing items if necessary. Don't confuse these methods with the `find()` and `insert()` routines in the `Tree234` class, which we'll look at next.

A display routine displays a node with slashes separating the data items, like `/27/56/89/`, `/14/66/`, or `/45/`.

Don't forget that in Java, references are automatically initialized to null and numbers to 0 when their object is created, so class `Node` doesn't need a constructor.

The `Tree234` Class

An object of the `Tree234` class represents the entire tree. The class has only one field: `root`, of type `Node`. All operations start at the root, so that's all a tree needs to remember.

Searching

Searching for a data item with a specified key is carried out by the `find()` routine. It starts at the root, and at each node calls that node's `findItem()` routine to see if the item is there. If so, it returns the index of the item within the node's item array.

If `find()` is at a leaf and can't find the item, the search has failed, so it returns `-1`. If it can't find the item in the current node, and the current node isn't a leaf, `find()` calls the `getNextChild()` method, which figures out which of a node's children the routine should go to next.

Inserting

The `insert()` method starts with code similar to `find()`, except that if it finds a full node it splits it. Also, it assumes it can't fail; it keeps looking, going to deeper and deeper levels, until it finds a leaf node. At this point it inserts the new data item into the leaf. (There is always room in the leaf, otherwise the leaf would have been split.)

Splitting

The `split()` method is the most complicated in this program. It is passed the node that will be split as an argument. First, the two rightmost data items are removed from the node and stored. Then the two rightmost children are disconnected; their references are also stored.

A new node, called `newRight`, is created. It will be placed to the right of the node being split. If the node being split is the root, an additional new node is created: a new root.

Next, appropriate connections are made to the parent of the node being split. It may be a pre-existing parent, or if the root is being split it will be the newly created root node. Assume the three data items in the node being split are called A, B, and C. Item B is inserted in this parent node. If necessary, the parent's existing children are disconnected and reconnected one position to the right to make room for the new data item and new connections. The `newRight` node is connected to this parent. (Refer to [Figures 10.5 and 10.6](#).)

Now the focus shifts to the `newRight` node. Data item C is inserted in it, and child 2 and child 3, which were previously disconnected from the node being split, are connected to it. The split is now complete, and the `split()` routine returns.

The Tree234App Class

In the `Tree234App` class, the `main()` routine inserts a few data items into the tree. It then presents a character-based interface for the user, who can enter `s` to see the tree, `i` to insert a new data item, and `f` to find an existing item. Here's some sample interaction:

```
Enter first letter of show, insert, or find: s
level=0 child=0 /50/
level=1 child=0 /30/40/
level=1 child=1 /60/70/
```

```
Enter first letter of show, insert, or find: f
Enter value to find: 40
Found 40
```

```
Enter first letter of show, insert, or find: i
Enter value to insert: 20
Enter first letter of show, insert, or find: s
level=0 child=0 /50/
level=1 child=0 /20/30/40/
level=1 child=1 /60/70/
```

```
Enter first letter of show, insert, or find: i
Enter value to insert: 10
Enter first letter of show, insert, or find: s
level=0 child=0 /30/50/
level=1 child=0 /10/20/
level=1 child=1 /40/
level=1 child=2 /60/70/
```

The output is not very intuitive, but there's enough information to draw the tree if you want. The level, starting with 0 at the root, is shown, as well as the child number. The display algorithm is depth-first, so the root is shown first, then its first child and the subtree of which the first child is the root, then the second child and its subtree, and so on.

The output shows two items being inserted, 20 and 10. The second of these caused a node (the root's child 0) to split. Figure 10.12 depicts the tree that results from these insertions, following the final press of the `s` key.

Listing for `tree234.java`

Listing 10.1 shows the complete `tree234.java` program, including all the classes just discussed. As with most object-oriented programs, it's probably easiest to start by reexamining the big picture classes first and then work down to the detail-oriented classes. In this program this order is `Tree234App`, `Tree234`, `Node`, `DataItem`.

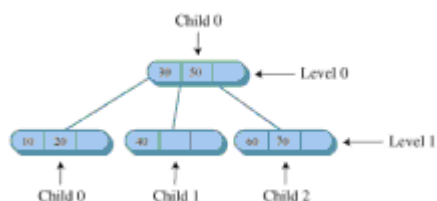

Figure 10.12: Sample output of tree234.java program

Listing 10.1 The tree234.java Program

```
// tree234.java
// demonstrates 234 tree
// to run this program: C>java Tree234App
import java.io.*;           // for I/O
import java.lang.Integer;   // for parseInt()
////////////////////////////////////
class DataItem
{
    public double dData;     // one data item

//-----
-
    public DataItem(double dd) // constructor
        { dData = dd; }

//-----
-
    public void displayItem() // display item, format "/27"
        { System.out.print("/"+dData); }

//-----
-
} // end class DataItem

////////////////////////////////////

class Node
{
    private static final int ORDER = 4;
    private int numItems;
    private Node parent;
    private Node childArray[] = new Node[ORDER];
    private DataItem itemArray[] = new DataItem[ORDER-1];

// -----
-
    // connect child to this node
    public void connectChild(int childNum, Node child)
        {
            childArray[childNum] = child;
            if(child != null)
                child.parent = this;
        }

// -----
-
    // disconnect child from this node, return it
    public Node disconnectChild(int childNum)
```

```

    {
    Node tempNode = childArray[childNum];
    childArray[childNum] = null;
    return tempNode;
    }

// -----
-
public Node getChild(int childNum)
    { return childArray[childNum]; }

// -----
-
public Node getParent()
    { return parent; }

// -----
-
public boolean isLeaf()
    { return (childArray[0]==null) ? true : false; }

// -----
-
public int getNumItems()
    { return numItems; }

// -----
-
public DataItem getItem(int index)    // get DataItem at
index
    { return itemArray[index]; }

// -----
-
public boolean isFull()
    { return (numItems==ORDER-1) ? true : false; }

// -----
-
public int findItem(double key)        // return index of
    {                                // item (within
node)
    for(int j=0; j<ORDER-1; j++)      // if found,
    {                                // otherwise,
        if(itemArray[j] == null)    // return -1
            break;
        else if(itemArray[j].dData == key)
            return j;
    }
    return -1;
    } // end findItem

// -----
-
public int insertItem(DataItem newItem)
    {

```

```

// assumes node is not full
numItems++; // will add new item
double newKey = newItem.dData; // key of new item

for(int j=ORDER-2; j>=0; j--) // start on right,
{ // examine items
if(itemArray[j] == null) // if item null,
continue; // go left one cell
else // not null,
{ // get its key
double itsKey = itemArray[j].dData;
if(newKey < itsKey) // if it's bigger
itemArray[j+1] = itemArray[j]; // shift it right
else
{
itemArray[j+1] = newItem; // insert new item
return j+1; // return index to
} // new item
} // end else (not null)
} // end for // shifted all
items,
itemArray[0] = newItem; // insert new item
return 0;
} // end insertItem()

// -----
-
public DataItem removeItem() // remove largest item
{
// assumes node not empty
DataItem temp = itemArray[numItems-1]; // save item
itemArray[numItems-1] = null; // disconnect it
numItems--; // one less item
return temp; // return item
}

// -----
-
public void displayNode() // format "/24/56/74/"
{
for(int j=0; j<numItems; j++)
itemArray[j].displayItem(); // "/56"
System.out.println("/"); // final "/"
}

// -----
-
} // end class Node

////////////////////////////////////

class Tree234
{
private Node root = new Node(); // make root node

```

```

// -----
-
public int find(double key)
{
    Node curNode = root;
    int childNumber;
    while(true)
    {
        if(( childNumber=curNode.findItem(key) ) != -1)
            return childNumber;          // found it
        else if( curNode.isLeaf() )
            return -1;                    // can't find it
        else                                // search deeper
            curNode = getNextChild(curNode, key);
    } // end while
}

// -----
-
// insert a DataItem
public void insert(double dValue)
{
    Node curNode = root;
    DataItem tempItem = new DataItem(dValue);

    while(true)
    {
        if( curNode.isFull() )            // if node full,
        {
            split(curNode);                // split it
            curNode = curNode.getParent(); // back up
                                           // search once
            curNode = getNextChild(curNode, dValue);
        } // end if(node is full)

        else if( curNode.isLeaf() )       // if node is
leaf,
            break;                          // go insert
        // node is not full, not a leaf; so go to lower level
        else
            curNode = getNextChild(curNode, dValue);
    } // end while

    curNode.insertItem(tempItem);          // insert new
DataItem
} // end insert()

// -----
-
public void split(Node thisNode)          // split the node
{
    // assumes node is full
    DataItem itemB, itemC;

```

```

Node parent, child2, child3;
int itemIndex;

itemC = thisNode.removeItem(); // remove items from
itemB = thisNode.removeItem(); // this node
child2 = thisNode.disconnectChild(2); // remove children
child3 = thisNode.disconnectChild(3); // from this node

Node newRight = new Node(); // make new node

if(thisNode==root) // if this is the root,
{
    root = new Node(); // make new root
    parent = root; // root is our
parent
    root.connectChild(0, thisNode); // connect to parent
}
else // this node not the
root
    parent = thisNode.getParent(); // get parent

// deal with parent
itemIndex = parent.insertItem(itemB); // item B to parent
int n = parent.getNumItems(); // total items?

for(int j=n-1; j>itemIndex; j--) // move
parent's
{
    // connections
    Node temp = parent.disconnectChild(j); // one child
    parent.connectChild(j+1, temp); // to the right
}

// connect newRight to
parent
parent.connectChild(itemIndex+1, newRight);

// deal with newRight
newRight.insertItem(itemC); // item C to newRight
newRight.connectChild(0, child2); // connect to 0 and 1
newRight.connectChild(1, child3); // on newRight
} // end split()

// -----
-
// gets appropriate child of node during search for value
public Node getNextChild(Node theNode, double theValue)
{
    int j;
    // assumes node is not empty, not full, not a leaf
    int numItems = theNode.getNumItems();
    for(j=0; j<numItems; j++) // for each item in
node
    {
        // are we less?
        if( theValue < theNode.getItem(j).dData )
            return theNode.getChild(j); // return left child
    }
}

```

```

        } // end for                                // we're greater, so
return theNode.getChild(j);                        // return right child
    }

// -----
-
public void displayTree()
{
    recDisplayTree(root, 0, 0);
}

// -----
-
private void recDisplayTree(Node thisNode, int level,
                             int childNumber)
{
    System.out.print("level="+level+" child="+childNumber+"
");
    thisNode.displayNode();                        // display this
node

    // call ourselves for each child of this node
    int numItems = thisNode.getNumItems();
    for(int j=0; j<numItems+1; j++)
    {
        Node nextNode = thisNode.getChild(j);
        if(nextNode != null)
            recDisplayTree(nextNode, level+1, j);
        else
            return;
    }
} // end recDisplayTree()

// -----
-\
    } // end class Tree234

////////////////////////////////////

class Tree234App
{
    public static void main(String[] args) throws IOException
    {
        double value;
        Tree234 theTree = new Tree234();

        theTree.insert(50);
        theTree.insert(40);
        theTree.insert(60);
        theTree.insert(30);
        theTree.insert(70);

        while(true)
        {

```



```

    putText("Enter first letter of ");
    putText("show, insert, or find: ");
    char choice = getChar();
    switch(choice)
    {
    case 's':
        theTree.displayTree();
        break;
    case 'i':
        putText("Enter value to insert: ");
        value = getInt();
        theTree.insert(value);
        break;
    case 'f':
        putText("Enter value to find: ");
        value = getInt();
        int found = theTree.find(value);
        if(found != -1)
            System.out.println("Found "+value);
        else
            System.out.println("Could not find "+value);
        break;
    default:
        putText("Invalid entry\n");
    } // end switch
} // end while
} // end main()

//-----
-
    public static void putText(String s)
    {
        System.out.print(s);
        System.out.flush();
    }

//-----
-
    public static String getString() throws IOException
    {
        InputStreamReader isr = new InputStreamReader(System.in);
        BufferedReader br = new BufferedReader(isr);
        String s = br.readLine();
        return s;
    }

//-----
-
    public static char getChar() throws IOException
    {
        String s = getString();
        return s.charAt(0);
    }

```

```
//-----
public static int getInt() throws IOException
{
    String s = getString();
    return Integer.parseInt(s);
}

//-----

} // end class Tree234App
```

2-3-4 Trees and Red-Black Trees

At this point 2-3-4 trees and red-black trees (described in [Chapter 9](#)) probably seem like entirely different entities. However, it turns out that in a certain sense they are completely equivalent. One can be transformed into the other by the application of a few simple rules, and even the operations needed to keep them balanced are equivalent. Mathematicians would say they were *isomorphic*.

You probably won't ever need to transform a 2-3-4 tree into a red-black tree, but equivalence of these structures casts additional light on their operation and is useful in analyzing their efficiency.

Historically the 2-3-4 tree was developed first; later the red-black tree evolved from it.

Transformation from 2-3-4 to Red-Black

A 2-3-4 tree can be transformed into a red-black tree by applying the following rules:

- Transform any 2-node in the 2-3-4 tree into a black node in the red-black tree.
- Transform any 3-node into a child C (with two children of its own) and a parent P (with children C and one other child). It doesn't matter which item becomes the child and which the parent. C is colored red and P is colored black.

Transform any 4-node into a parent P and two children C1 and C2, both with two children of their own. C1 and C2 are colored red and P is black.

Figure 10.13 shows these transformations. The child nodes in these subtrees are colored red; all other nodes are colored black.

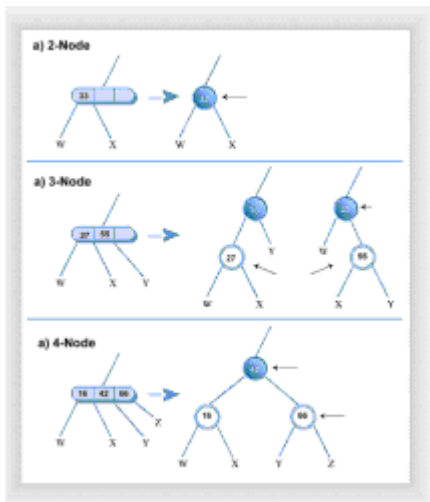

Figure 10.13: Transformations: 2-3-4 to red-black

Figure 10.14 shows a 2-3-4 tree and the corresponding red-black tree obtained by applying these transformations. Dotted lines surround the subtrees that were made from 3-nodes and 4-nodes. The red-black rules are automatically satisfied by the transformation. Check that this is so: two red nodes are never connected, and there is the same number of black nodes on every path from root to leaf (or null child).

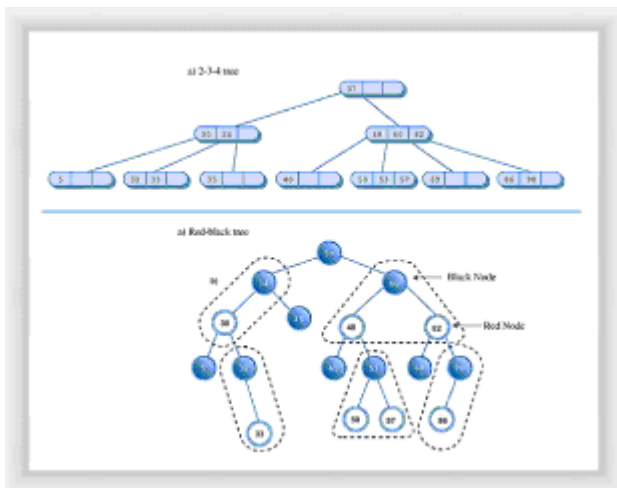

Figure 10.14: A 2-3-4 tree and its red-black equivalent

You can say that a 3-node in a 2-3-4 tree is equivalent to a parent with a red child in a red-black tree, and a 4-node is equivalent to a parent with two red children. It follows that a black parent with a black child in a red-black tree does *not* represent a 3-node in a 2-3-4 tree; it simply represents a 2-node with another 2-node child. Similarly, a black parent with two black children does not represent a 4-node.

Operational Equivalence

Not only does the structure of a red-black tree correspond to a 2-3-4 tree, but the operations applied to these two kinds of trees are also equivalent. In a 2-3-4 tree the tree is kept balanced using node splits. In a red-black tree the two balancing methods are color flips and rotations.

4-Node Splits and Color Flips

As you descend a 2-3-4 tree searching for the insertion point for a new node, you split each 4-node into two 2-nodes. In a red-black tree you perform color flips. How are these operations equivalent?

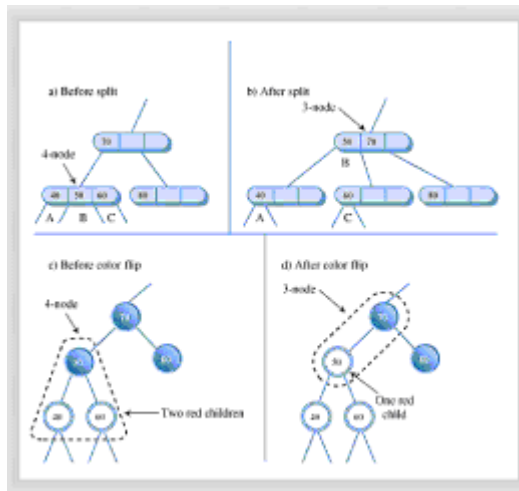

Figure 10.15: 4-node split and color flip

In Figure 10.15-a we show a 4-node in a 2-3-4 tree before it is split; Figure 10.15-b shows the situation after the split. The 2-node that was the parent of the 4-node becomes a 3-node.

In Figure 10.15-c we show the red-black equivalent to the 2-3-4 tree in 10.15-a. The dotted line surrounds the equivalent of the 4-node. A color flip results in the red-black tree of Figure 10.15-d. Now nodes 40 and 60 are black and 50 is red. Thus 50 and its parent form the equivalent of a 3-node, as shown by the dotted line. This is the same 3-node formed by the node split in Figure 10.15-b.

Thus we see that splitting a 4-node during the insertion process in a 2-3-4 tree is equivalent to performing color flips during the insertion process in a red-black tree.

3-Node Splits and Rotations

When a 3-node in a 2-3-4 tree is transformed into its red-black equivalent, two arrangements are possible, as we showed earlier in Figure 10.13-b. Either of the two data items can become the parent. Depending on which one is chosen, the child will be either a left child or a right child, and the slant of the line connecting parent and child will be either left or right.

Both arrangements are valid; however, they may not contribute equally to balancing the tree. Let's look at the situation in a slightly larger context.

Figure 10.16-a shows a 2-3-4 tree, and 10.16-b and 10.16-c show two equivalent red-black trees derived from the 2-3-4 tree by applying the transformation rules. The difference between them is the choice of which of the two data items in the 3-node to make the parent; in b) 80 is the parent, in c) it's 70.

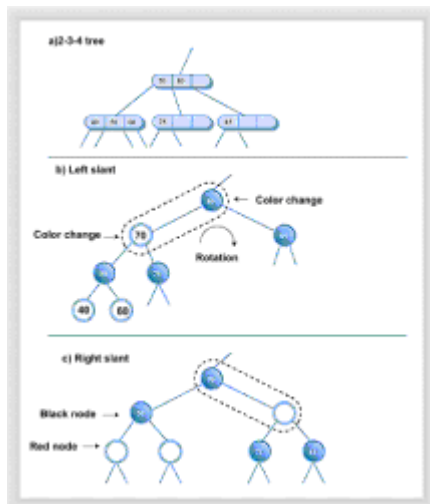

Figure 10.16: 3-node and rotation

Although these arrangements are equally valid, you can see that the tree in b) is not balanced, while that in c) is. Given the red-black tree in b), we would want to rotate it to the right (and perform two color changes) to balance it. Amazingly, this rotation results in the exact same tree shown in c).

Thus we see an equivalence between rotations in red-black trees and the choice of which node to make the parent when transforming 2-3-4 trees to red-black trees. Although we don't show it, a similar equivalence can be seen for the double rotation necessary for inside grandchildren.

Efficiency of 2-3-4 Trees

It's harder to analyze the efficiency of a 2-3-4 tree than a red-black tree, but the equivalence of red-black trees and 2-3-4 trees gives us a starting point.

Speed

As we saw in [Chapter 8](#), in a red-black tree one node on each level must be visited during a search, whether to find an existing node or insert a new one. The number of levels in a red-black tree (a balanced binary tree) is about $\log_2(N+1)$, so search times are proportional to this.

One node must be visited at each level in a 2-3-4 tree as well, but the 2-3-4 tree is shorter (has fewer levels) than a red-black tree with the same number of data items. Refer to [Figure 10.14](#), where the 2-3-4 tree has three levels and the red-black tree has five.

More specifically, in 2-3-4 trees there are up to 4 children per node. If every node were full, the height of the tree would be proportional to $\log_4 N$. Logarithms to the base 2 and to the base 4 differ by a constant factor of 2. Thus, the height of a 2-3-4 tree would be about half that of a red-black tree, provided that all the nodes were full. Because they aren't all full, the height of the 2-3-4 tree is somewhere between $\log_2(N+1)$ and $\log_2(N+1)/2$.

Thus, the reduced height of the 2-3-4 tree decreases search times slightly compared with red-black trees.

On the other hand, there are more items to examine in each node, which increases the search time. Because the data items in the node are examined using a linear search, this multiplies the search times by an amount proportional to M , the average number of items

per node. The result is a search time proportional to $M \cdot \log_4 N$.

Some nodes contain 1 item, some 2, and some 3. If we estimate that the average is 2, search times will be proportional to $2 \cdot \log_4 N$. This is a small constant number that can be ignored in Big O notation.

Thus, for 2-3-4 trees the increased number of items per node tends to cancel out the decreased height of the tree. The search times for a 2-3-4 tree and for a balanced binary tree such as a red-black tree are approximately equal, and are both $O(\log N)$.

Storage Requirements

Each node in a 2-3-4 tree contains storage for three references to data items and four references to its children. This space may be in the form of arrays, as shown in `tree234.java`, or of individual variables. Not all this storage is used. A node with only one data item will waste two thirds of the space for data and half the space for children. A node with two data items will waste one third of the space for data and one quarter of the space for children; to put it another way, it will use $5/7$ of the available space.

If we take two data items per node as the average utilization, about $2/7$ of the available storage is wasted.

One might imagine using linked lists instead of arrays to hold the child and data references, but the overhead of the linked list compared with an array, for only 3 or 4 items, would probably not make this a worthwhile approach.

Because they're balanced, red-black trees contain few nodes that have only one child, so almost all the storage for child references is used. Also, every node contains the maximum number of data items, which is 1. This makes red-black trees more efficient than 2-3-4 trees in terms of memory usage.

In Java, which stores references to objects instead of the objects themselves, this difference in storage between 2-3-4 trees and red-black trees may not be important, and the programming is certainly simpler for 2-3-4 trees. However, in languages that don't use references this way, the difference in storage efficiency between red-black trees and 2-3-4 trees may be significant.

External Storage

2-3-4 trees are an example of multiway trees, which have more than two children and more than one data item. Another kind of multiway tree, the B-tree, is useful when data resides in external storage. *External storage* typically refers to some kind of disk system, such as the hard disk found in most desktop computers or servers.

In this section we'll begin by describing various aspects of external file handling. We'll talk about a simple approach to organizing external data: sequential ordering. Finally we'll discuss B-trees and explain why they work so well with disk files. We'll finish with another approach to external storage, indexing, which can be used alone or with a B-tree.

We'll also touch on other aspects of external storage, such as searching techniques. In the next chapter we'll mention a different approach to external storage: hashing.

The details of external storage techniques are dependent on the operating system, language, and even the hardware used in a particular installation. As a consequence, our discussion in this section will be considerably more general than for most topics in this book.

Accessing External Data

The data structures we've discussed so far are all based on the assumption that data is stored entirely in main memory (often called RAM, for Random Access Memory). However, in many situations the amount of data to be processed is too large to fit in main memory all at once. In this case a different kind of storage is necessary. Disk files generally have a much larger capacity than main memory; this is made possible by their lower cost per byte of storage.

Of course, disk files have another advantage: their permanence. When you turn off your computer (or the power fails), the data in main memory is lost. Disk files can retain data indefinitely with the power off. However, it's mostly the size difference that we'll be involved with here.

The disadvantage of external storage is that it's much slower than main memory. This speed difference means that different techniques must be used to handle it efficiently.

As an example of external storage, imagine that you're writing a database program to handle the data found in the phone book for a medium-sized city; perhaps 500,000 entries. Each entry includes a name, address, phone number, and various other data used internally by the phone company. Let's say an entry is stored as a record requiring 512 bytes. The result is a file size of $500,000 \times 512$, which is 256,000,000 bytes or 256 megabytes. We'll assume that on the target machine this is too large to fit in main memory, but small enough to fit on your disk drive.

Thus you have a large amount of data on your disk drive. How do you structure it to provide the usual desirable characteristics: quick search, insertion, and deletion?

In investigating the answers, you must keep in mind two facts. First, accessing data on a disk drive is much slower than accessing it in main memory. Second, you must access many records at once. Let's explore these points.

Very Slow Access

A computer's main memory works electronically. Any byte can be accessed just as fast as any other byte, in a fraction of a microsecond (a millionth of a second).

Things are more complicated with disk drives. Data is arranged in circular tracks on a spinning disk, something like the tracks on a compact disc (CD) or the grooves in an old-style phonograph record.

To access a particular piece of data on a disk drive, the read-write head must first be moved to the correct track. This is done with a stepping motor or similar device; it's a mechanical activity that requires several milliseconds (thousandths of a second).

Once the correct track is found, the read-write head must wait for the data to rotate into position. On the average, this takes half a revolution. Even if the disk is spinning at 10,000 revolutions per minute, about 3 more milliseconds pass before the data can be read. Once the read-write head is positioned, the actual reading (or writing) process begins; this might take a few more milliseconds.

Thus, disk access times of around 10 milliseconds are common. This is something like 10,000 times slower than main memory.

Technological progress is reducing disk access times every year, but main memory access times are being reduced faster, so the disparity between disk access and main memory access times will grow even larger in the future.

One Block at a Time

Once it is correctly positioned and the reading (or writing) process begins, a disk drive can transfer a large amount of data to main memory fairly quickly. For this reason, and to

simplify the drive control mechanism, data is stored on the disk in chunks called *blocks*, *pages*, *allocation units*, or some other name, depending on the system. We'll call them blocks.

The disk drive always reads or writes a minimum of one block of data at a time. Block size varies, depending on the operating system, the size of the disk drive, and other factors, but it is usually a power of 2. For our phone book example, let's assume a block size of 8,192 bytes (2^{13}). Thus our phone book database will require 256,000,000 bytes divided by 8,192 bytes per block, which is 31,250 blocks.

Your software is most efficient when it specifies a read or write operation that's a multiple of the block size. If you ask to read 100 bytes, the system will read one block, 8,192 bytes, and throw away all but 100. Or if you ask to read 8,200 bytes, it will read two blocks, or 16,384 bytes, and throw away almost half of them. By organizing your software so that it works with a block of data at a time you can optimize its performance.

Assuming our phone book record size of 512 bytes, you can store 16 records in a block (8,192 divided by 512), as shown in Figure 10.17. Thus for maximum efficiency it's important to read 16 records at a time (or multiples of this number).

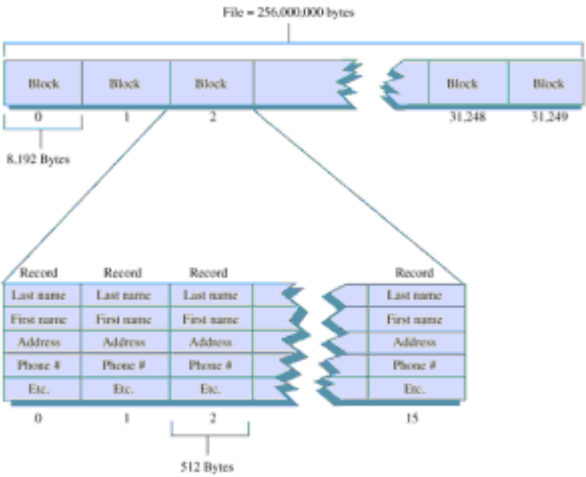

Figure 10.17: Blocks and records

Notice that it's also useful to make your record size a multiple of 2. That way an integral number of them will always fit in a block.

Of course the sizes shown in our phone book example for records, blocks, and so on are only illustrative; they will vary widely depending on the number and size of records and other software and hardware constraints. Blocks containing hundreds of records are common, and records may be much larger or smaller than 512 bytes.

Once the read-write head is positioned as described earlier, reading a block is fairly fast, requiring only a few milliseconds. Thus a disk access to read or write a block is not very dependent on the size of the block. It follows that the larger the block, the more efficiently you can read or write a single record (assuming you use all the records in the block).

Sequential Ordering

One way to arrange the phone book data in the disk file would be to order all the records according to some key, say alphabetically by last name. The record for Joseph Aardvark would come first, and so on. This is shown in Figure 10.18.



Figure 10.18: Sequential ordering

Searching

To search a sequentially ordered file for a particular last name such as Smith, you could use a binary search. You would start by reading a block of records from the middle of the file. The 16 records in the block are all read at once into a 8,192-byte buffer in main memory.

If the keys of these records are too early in the alphabet (Keller, for example), you'd go to the 3/4 point in the file (Prince) and read a block there; if the keys were too late, you'd go to the 1/4 point (DeLeon). By continually dividing the range in half you'd eventually find the record you were looking for.

As we saw in [Chapter 2](#), a binary search in main memory takes $\log_2 N$ comparisons, which for 500,000 items is about 19. If every comparison took, say 10 microseconds, this would be 190 microseconds, or about 2/10,000 of a second; less than an eye blink.

However, we're now dealing with data stored on a disk. Because each disk access is so time consuming, it's more important to focus on how many disk accesses are necessary than on how many individual records there are. The time to read a block of records will be very much larger than the time to search the 16 records in the block once they're in memory.

Disk accesses are much slower than memory accesses, but on the other hand we access a block at a time, and there are far fewer blocks than records. In our example there are 31,250 blocks. \log_2 of this number is about 15, so in theory we'll need about 15 disk accesses to find the record we want.

In practice this number is reduced somewhat because we read 16 records at once. In the beginning stages of a binary search it doesn't help to have multiple records in memory because the next access will be in a distant part of the file. However, when we get close to the desired record, the next record we want may already be in memory because it's part of the same block of 16. This may reduce the number of comparisons by two or so. Thus we'll need about 13 disk accesses ($15 - 2$), which at 10 milliseconds per access requires about 130 milliseconds, or 1/7 second. This is much slower than in-memory access, but still not too bad.

Insertion

Unfortunately the picture is much worse if we want to insert (or delete) an item from a sequentially ordered file. Because the data is ordered, both operations require moving half the records on the average, and therefore about half the blocks.

Moving each block requires two disk accesses, one read and one write. Once the insertion point is found, the block containing it is read into a memory buffer. The last record in the block is saved, and the appropriate number of records are shifted up to make room for the new one, which is inserted. Then the buffer contents are written back to the disk file.

Next the second block is read into the buffer. Its last record is saved, all the other records are shifted up, and the last record from the previous block is inserted at the External Storage beginning of the buffer. Then the buffer contents are again written back to disk. This process continues until all the blocks beyond the insertion point have been rewritten.

Assuming there are 31,250 blocks, we must read and write (on the average) 15,625 of them, which at 10 milliseconds per read and write requires more than five minutes to insert a single entry. This won't be satisfactory if you have thousands of new names to add to the phone book.

Another problem with the sequential ordering is that it only works quickly for one key. Our file is arranged by last names. But suppose you wanted to search for a particular phone number. You can't use a binary search, because the data is ordered by name. You would need to go through the entire file, block by block, using sequential access. This would require reading an average of half the blocks, which would require about 2.5 minutes, very poor performance for a simple search. It would be nice to have a more efficient way to store disk data.

B-Trees

How can the records of a file be arranged to provide fast search, insertion, and deletion times? We've seen that trees are a good approach to organizing in-memory data. Will trees work with files?

They will, but a different kind of tree must be used for external data than for in-memory data. The appropriate tree is a multiway tree somewhat like a 2-3-4 tree, but with many more data items per node; it's called a *B-tree*. B-trees were first conceived as appropriate structures for external storage by R. Bayer and E. M. McCreight in 1972.

One Block Per Node

Why do we need so many items per node? We've seen that disk access is most efficient when data is read or written one block at a time. In a tree, the entity containing data is a node. It makes sense then to store an entire block of data in each node of the tree. This way, reading a node accesses a maximum amount of data in the shortest time.

How much data can be put in a node? When we simply stored the 512-byte data records for our phone book example, we could fit 16 into a 8,192-byte block.

In a tree, however, we also need to store the links to other nodes (which means links to other blocks, because a node corresponds to a block). In an in-memory tree, such as those we've discussed in previous chapters, these links are references (or pointers, in languages like C++) to nodes in other parts of memory. For a tree stored in a disk file, the links are block numbers in a file (from 0 to 31,249, in our phone book example). For block numbers we can use a field of type `int`, a 4-byte type, which can point to more than 2 billion possible blocks; probably enough for most files. Now we can no longer squeeze 16 512-byte records into a block, because we need room for the links to child nodes. We could reduce the number of records to 15 to make room for the links, but it's most efficient to have an even number of records per node, so (after appropriate negotiation with management) we reduce the record size to 507 bytes. There will be 17 child links (one more than the number of data items) so the links will require 68 bytes (17x4). This leaves room for 16 507-byte records with 12 bytes left over (507x16 + 68 = 8,180). A block in such a tree, and the corresponding node representation, is shown in Figure 10.19.

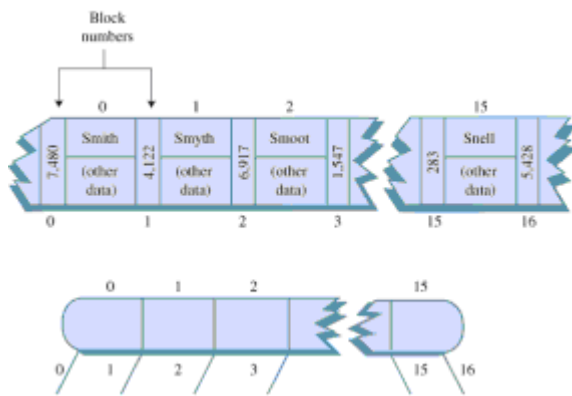

Figure 10.19: A node in a B-tree of order 17

Within each node the data is ordered sequentially by key, as in a 2-3-4 tree. In fact, the structure of a B-tree is similar to that of a 2-3-4 tree, except that there are more data items per node and more links to children. The order of a B-tree is the number of children each node can potentially have. In our example this is 17, so the tree is an order 17 B-tree.

Searching

A search for a record with a specified key is carried out in much the same way it is in an in-memory 2-3-4 tree. First, the block containing the root is read into memory. The search algorithm then starts examining each of the 15 records (or, if it's not full, as many as the node actually holds), starting at 0. When it finds a record with a greater key, it knows to go to the child whose link lies between this record and the preceding one.

This process continues until the correct node is found. If a leaf is reached without finding the specified key, the search is unsuccessful.

Insertion

The insertion process in a B-tree is somewhat different than it is in a 2-3-4 tree. Recall that in a 2-3-4 tree many nodes are not full, and in fact contain only one data item. In particular, a node split always produces two nodes with one item in each. This is not an optimum approach in a B-tree.

In a B-tree it's important to keep the nodes as full as possible so that each disk access, which reads an entire node, can acquire the maximum amount of data. To help achieve this end, the insertion process differs from that of 2-3-4 trees in three ways:

- A node split divides the data items equally: half go to the newly created node, and half remain in the old one.
- Node splits are performed from the bottom up rather than from the top down.
- It's not the middle item in a node that's promoted upward, but the middle item in the sequence formed from the items in the node plus the new item.

We'll demonstrate these features of the insertion process by building a small B-tree, as shown in Figure 10.20. There isn't room to show a realistic number of records per node, so we'll show only four; thus the tree is an order 5 B-tree.

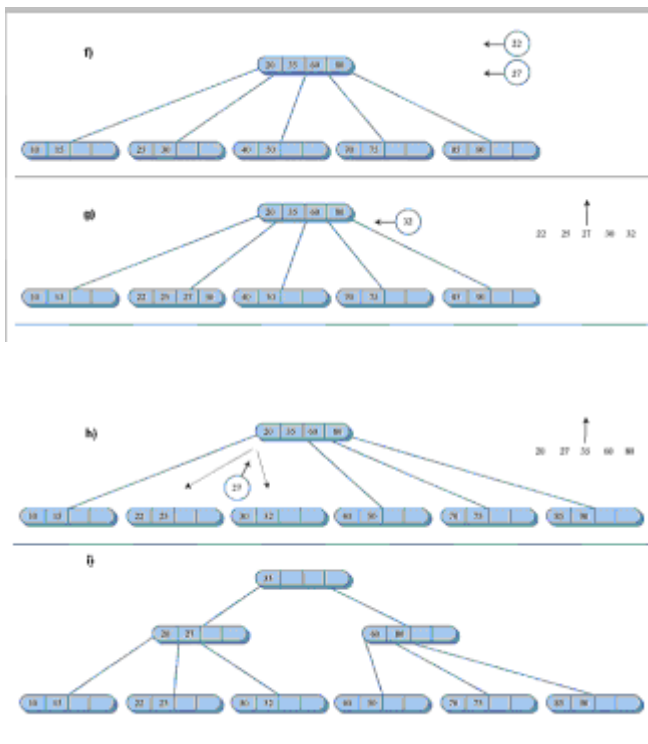
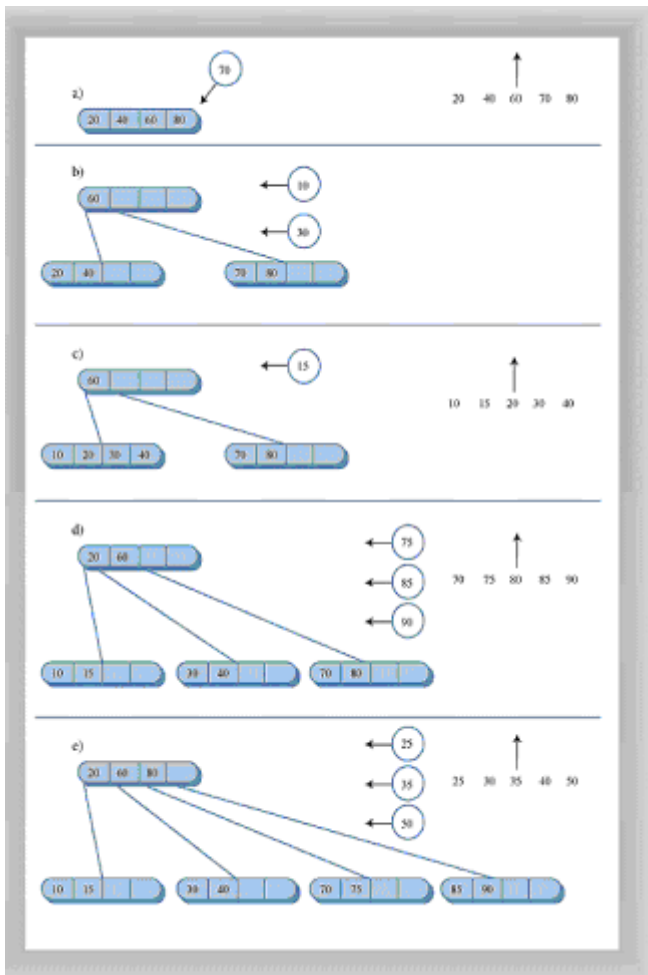

Figure 10.20: Building a B-tree

Figure 10.20-a shows a root node that's already full; items with keys 20, 40, 60, and 80 have already been inserted into the tree. A new data item with a key of 70 is inserted, resulting in a node split. Here's how the split is accomplished. Because it's the root that's being split, two new nodes are created (as in a 2-3-4 tree): a new root and a new node to the right of the one being split.

To decide where the data items go, the insertion algorithm arranges their 5 keys in order, in an internal buffer. Four of these keys are from the node being split, and the fifth is from the new item being inserted. In Figure 10.20, these 5-item sequences are shown to the side of the tree. In this first step the sequence 20, 40, 60, 70, 80 is shown.

The center item in this sequence, 60 in this first step, is promoted to the new root node. (In the figure, an arrow indicates that the center item will go upward.) All the items to the left of center remain in the node being split, and all the items to the right go into the new right-hand node. The result is shown in Figure 10.20-b. (In our phone book example, 8 items would go into each child node, rather than the 2 shown in the figure.)

In Figure 10.20-b we insert two more items, 10 and 30. They fill up the left child, as shown in Figure 10.20-c. The next item to be inserted, 15, splits this left child, with the result shown in Figure 10.20-d. Here the 20 has been promoted upward into the root.

Next, three items, 75, 85, and 90, are inserted into the tree. The first two fill up the third child, and the third splits it, causing the creation of a new node and the promotion of the middle item, 80, to the root. The result is shown in Figure 10.20-e.

Again three items, 25, 35, and 50, are added to the tree. The first two items fill up the second child, and the third one splits it, causing the creation of a new node and the promotion of the middle item, 35, to the root, as shown in Figure 10.20-f.

Now the root is full. However, subsequent insertions don't necessarily cause a node split, because nodes are split only when a new item is inserted into a full node, not when a full node is encountered in the search down the tree. Thus 22 and 27 are inserted in the second child without causing any splits, as shown in Figure 10.20-g.

However, the next item to be inserted, 32, does cause a split; in fact it causes two of them. The second node child is full, so it's split, as shown in Figure 10.20-b. However, the 27, promoted from this split, has no place to go because the root is full. Therefore, the root must be split as well, resulting in the arrangement of Figure 10.20-j.

Notice that throughout the insertion process no node (except the root) is ever less than half full, and many are more than half full. As we noted, this promotes efficiency because a file access that reads a node always acquires a substantial amount of data.

Efficiency of B-Trees

Because there are so many records per node, and so many nodes per level, operations on B-trees are very fast, considering that the data is stored on disk. In our phone book example there are 500,000 records. All the nodes in the B-tree are at least half full, so they contain at least 8 records and 9 links to children. The height of the tree is thus somewhat less than $\log_9 N$ (logarithm to the base 9 of N), where N is 500,000. This is 5.972, so there will be about 6 levels in the tree.

Thus, using a B-tree, only six disk accesses are necessary to find any record in a file of 500,000 records. At 10 milliseconds per access, this takes about 60 milliseconds, or 6/100 of a second. This is dramatically faster than the binary search of a sequentially ordered file.

The more records there are in a node, the fewer levels there are in the tree. We've seen that there are 6 levels in our B-tree, even though the nodes hold only 16 records. In

contrast, a binary tree with 500,000 items would have about 19 levels, and a 2-3-4 tree would have 10. If we use blocks with hundreds of records, we can reduce the number of levels in the tree and further improve access times.

Although searching is faster in B-trees than in sequentially ordered disk files, it's for insertion and deletion that B-trees show the greatest advantage.

Let's first consider a B-tree insertion in which no nodes need to be split. This is the most likely scenario, because of the large number of records per node. In our phone book example, as we've seen, only 6 accesses are required to find the insertion point. Then one more access is required to write the block containing the newly inserted record back to the disk; a total of 7 accesses.

Next let's see how things look if a node must be split. The node being split must be read, have half its records removed, and be written back to disk. The newly created node must be written to the disk, and the parent must be read and, following the insertion of the promoted record, written back to disk. This is 5 accesses in addition to the six necessary to find the insertion point, for a total of 12. This is a major improvement over the 500,000 accesses required for insertion in a sequential file.

In some versions of the B-tree, only leaf nodes contain records. Non-leaf nodes contain only keys and block numbers. This may result in faster operation because each block can hold many more block numbers. The resulting higher-order tree will have fewer levels, and access speed will be increased. However, programming may be complicated because there are two kinds of nodes: leaves and non-leaves.

Indexing

A different approach to speeding up file access is to store records in sequential order but use a file *index* along with the data itself. A file index is a list of key/block pairs, arranged with the keys in order. Recall that in our original phone book example we had 500,000 records of 512 bytes each, stored 16 records to a block, in 31,250 blocks. Assuming our search key is the last name, every entry in the index contains two items:

- The key, such as Jones.
- The number of the block where the Jones record is located within the file. These numbers run from 0 to 31,249.

Let's say we use a string 28 bytes long for the key (big enough for most last names), and 4 bytes for the block number (a type `int` in Java). Each entry in our index thus requires 32 bytes. This is only 1/16 the amount necessary for each record.

The entries in the index are arranged sequentially by last name. The original records on the disk can be arranged in any convenient order. This usually means that new records are simply appended to the end of the file, so the records are ordered by time of insertion. This arrangement is shown in Figure 10.21.

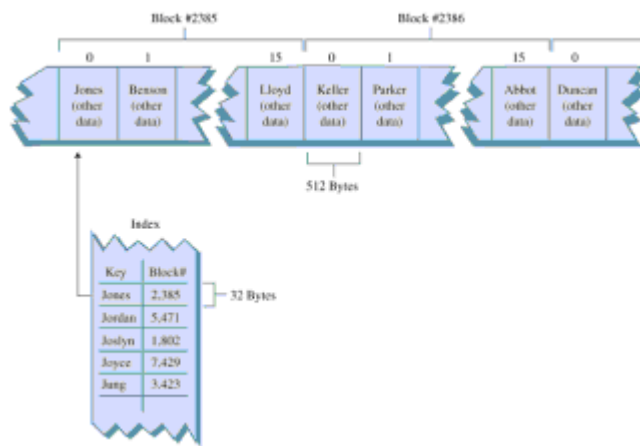

Figure 10.21: A file index

Index File in Memory

Because it's so much smaller than the file containing actual records, it may be that the index is small enough to fit entirely in main memory. In our example there are 500,000 records. Each one has a 32-byte entry in the index, so the index will be $32 \times 500,000$ or 1,600,000 bytes long (1.6 megabytes). In modern computers there's no problem fitting this in memory. The index can be stored on the disk, but read into memory whenever the database program is started up. From then on, operations on the index can take place in memory. At the end of the day (or perhaps more frequently) the index can be written back to disk for permanent storage.

Searching

The index-in-memory approach allows much faster operations on the phone book file than are possible with a file in which the records themselves are arranged sequentially. For example, a binary search requires 19 index accesses. At 20 microseconds per access, that's only about $4/10,000$ of a second. Then there's (inevitably) the time to read the actual record from the file, once its block number has been found in the index. However, this is only one disk access of (say) 10 milliseconds.

Insertion

To insert a new item in an indexed file two steps are necessary. We first insert its full record into the main file; then we insert an entry, consisting of the key and the block number where the new record is stored, into the index.

Because the index is in sequential order, to insert a new item we need to move half the index entries, on the average. Figuring 2 microseconds to move a byte in memory, we have $250,000 \times 32 \times 2$, or about 16 seconds to insert a new entry. This compares with five minutes for the unindexed sequential file. (Note that we don't need to move any records in the main file; we simply append the new record at the end of the file.)

Of course, you can use a more sophisticated approach to storing the index in memory. You could store it as a binary tree, 2-3-4 tree, or red-black tree, for example. Any of these would significantly reduce insertion and deletion times. In any case the index-in-memory approach is much faster than the sequential-file approach. In some cases it will also be faster than a B-tree.

The only actual disk accesses necessary for an insertion into an indexed file involve the new record itself. Usually the last block in the file is read into memory, the new record is

appended, and the block is written back out. This involves only two file accesses.

Multiple Indexes

An advantage of the indexed approach is that multiple indexes, each with a different key, can be created for the same file. In one index the keys can be last names, in another telephone numbers, in another addresses. Because the indexes are small compared with the file, this doesn't increase the total data storage very much. Of course, it does present more of a challenge when items are deleted from the file, because entries must be deleted from all the indexes, but we won't get into that here.

Index Too Large for Memory

If the index is too large to fit in memory, it must be broken into blocks and stored on the disk. For large files it may then be profitable to store the index itself as a B-tree. In the main file the records are stored in any convenient order.

This arrangement can be very efficient. Appending records to the end of the main file is a fast operation, and the index entry for the new record is also quick to insert because the index is a tree. The result is very fast searching and insertion for large files.

Note that when an index is arranged as a B-tree, each node contains a number of child pointers and one fewer data items. The child pointers are the block numbers of other nodes in the index. The data items consist of a key value and a pointer to a block in the main file. Don't confuse these two kinds of block pointers.

Complex Search Criteria

In complex searches the only practical approach may be to read every block in a file sequentially. Suppose in our phone book example we wanted a list of all entries in the phone book with first name Frank, who lived in Springfield, and who had a phone number with three "7" digits in it. (These were perhaps clues found scrawled on a scrap of paper clutched in the hand of a victim of foul play.)

A file organized by last names would be no help at all. Even if there were index files ordered by first names and cities, there would be no convenient way to find which files contained both Frank and Springfield. In such cases (which are quite common in many kinds of databases) the fastest approach is probably to read the file sequentially, block by block, checking each record to see if it meets the criteria.

Sorting External Files

Mergesort is the preferred algorithm for sorting external data. This is because, more so than most sorting techniques, disk accesses tend to occur in adjacent records rather than random parts of the file.

Recall from [Chapter 6, "Recursion,"](#) that mergesort works recursively by calling itself to sort smaller and smaller sequences. Once two of the smallest sequences (one byte each in the internal-memory version) have been sorted, they are then merged into a sorted sequence twice as long. Larger and larger sequences are merged, until eventually the entire file is sorted.

The approach for external storage is similar. However, the smallest sequence that can be read from the disk is a block of records. Thus, a two-stage process is necessary.

In the first phase, a block is read, its records are sorted internally, and the resulting sorted block is written back to disk. The next block is similarly sorted and written back to disk. This continues until all the blocks are internally sorted.

In the second phase, two sorted blocks are read, merged into a two-block sequence, and written back to disk. This continues until all pairs of blocks have been merged. Next each pair of 2-block sequences is merged into a 4-block sequence. Each time the size of the sorted sequences doubles, until the entire file is sorted.

Figure 10.22 shows the mergesort process on an external file. The file consists of four blocks of four records each, for a total of 16 records. Only three blocks can fit in internal memory. (Of course all these sizes would be much larger in a real situation.) Figure 10.22-a shows the file before sorting; the number in each record is its key value.

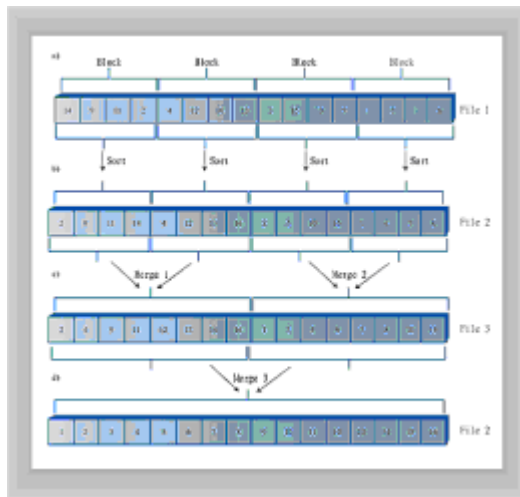

Figure 10.22: Mergesort on an external file

Internal Sort of Blocks

In the first phase all the blocks in the file are sorted internally. This is done by reading the block into memory and sorting it with any appropriate internal sorting algorithm, such as Quicksort (or for smaller numbers of records, shellsort or insertion sort). The result of sorting the blocks internally is shown in Figure 10.22-b. The dotted lines in the figure separate sorted records; solid lines separate unsorted records.

A second file may be used to hold the sorted blocks, and we assume that availability of external storage is not a problem. It's often desirable to avoid modifying the original file.

Merging

In the second phase we want to merge the sorted blocks. In the first pass we merge every pair of blocks into a sorted 2-block sequence. Thus the two blocks 2-9-11-14 and 4-12-13-16 are merged into 2-4-9-11-12-13-14-16. Also, 3-5-10-15 and 1-6-7-8 are merged into 1-3-5-6-7-8-10-15. The result is shown in Figure 10.22-c. A third file is necessary to hold the result of this merge step.

In the second pass, the two 8-record sequences are merged into a 16-record sequence, and the sort is complete. Of course more merge steps would be required to sort larger files; the number of such steps is proportional to $\log_2 N$. The merge steps can alternate between two files.

Internal Arrays

Because the computer's internal memory has room for only three blocks, the merging process must take place in stages. Let's say there are three arrays, called `arr1`, `arr2`, and `arr3`, each of which can hold a block.

In the first merge, block 2-9-11-14 is read into `arr1`, and 4-12-13-16 is read into `arr2`. These two arrays are then merge-sorted into `arr3`. However, because `arr3` holds only one block, it becomes full before the sort is completed. When it becomes full, its contents are written to disk. The sort then continues, filling up `arr3` again. This completes the sort, and `arr3` is again written to disk. The following lists show the details of each of the three mergesorts.

Mergesort 1:

1. Read 2-9-11-14 into `arr1`
2. Read 4-12-13-16 into `arr2`
3. Merge 2, 4, 9, 11 into `arr3`; write to disk
4. Merge 12, 13, 14, 16 into `arr3`; write to disk

Mergesort 2:

1. Read 3-5-10-15 into `arr1`
2. Read 1-6-7-8 into `arr2`
3. Merge 1, 3, 5, 6 into `arr3`; write to disk
4. Merge 7, 8, 10, 15 into `arr3`, write to disk

Mergesort 3:

1. Read 2-4-9-11 into `arr1`
2. Read 1-3-5-6 into `arr2`
3. Merge 1, 2, 3, 4 into `arr3`; write to disk
4. Merge 5, 6 into `arr3` (`arr2` is now empty)
5. Read 7-8-10-15 into `arr2`
6. Merge 7, 8 into `arr3`; write to disk
7. Merge 9, 10, 11 into `arr3` (`arr1` is now empty)
8. Read 12-13-14-16 into `arr1`
9. Merge 12 into `arr3`; write to disk
10. Merge 13, 14, 15, 16 into `arr3`; write to disk

This last sequence of 10 steps is rather lengthy, so it may be helpful to examine the details of the array contents as the steps are completed. Figure 10.23 shows how these arrays look at various stages of Mergesort 3.

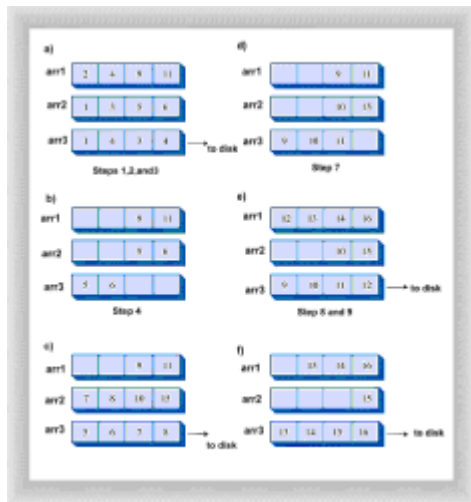

Figure 10.23: Array contents during Mergesort 3

Summary

- A multiway tree has more keys and children than a binary tree.
- A 2-3-4 tree is a multiway tree with up to three keys and four children per node.
- In a multiway tree, the keys in a node are arranged in ascending order.
- In a 2-3-4 tree, all insertions are made in leaf nodes, and all leaf nodes are on the same level.
- Three kinds of nodes are possible in a 2-3-4 tree: A 2-node has one key and two children, a 3-node has two keys and three children, and a 4-node has three keys and four children.
- There is no 1-node in a 2-3-4 tree.
- In a search in a 2-3-4 tree, at each node the keys are examined. If the search key is not found the next node will be child 0 if the search key is less than key 0; child 1 if the search key is between key 0 and key 1; child 2 if the search key is between key 1 and key 2; and child 3 if the search key is greater than key 2.
- Insertion into a 2-3-4 tree requires that any full node be split on the way down the tree, during the search for the insertion point.
- Splitting the root creates two new nodes; splitting any other node creates one new node.
- The height of a 2-3-4 tree can increase only when the root is split.
- There is a one-to-one correspondence between a 2-3-4 tree and a red-black tree.
- To transform a 2-3-4 tree into a red-black tree, make each 2-node into a black node, make each 3-node into a black parent with a red child, and make each 4-node into a black parent with two red children.
- When a 3-node is transformed into a parent and child, either node can become the parent.

- Splitting a node in a 2-3-4 tree is the same as performing a color flip in a red-black tree.
- A rotation in a red-black tree corresponds to changing between the two possible orientations (slants) when transforming a 3-node.
- The height of a 2-3-4 tree is less than $\log_2 N$.
- Search times are proportional to the height.
- The 2-3-4 tree wastes space because many nodes are not even half full.
- External storage means storing data outside of main memory; usually on a disk.
- External storage is larger, cheaper (per byte), and slower than main memory.
- Data in external storage is typically transferred to and from main memory a block at a time.
- Data can be arranged in external storage in sequential key order. This gives fast search times but slow insertion (and deletion) times.
- A B-tree is a multiway tree in which each node may have dozens or hundreds of keys and children.
- There is always one more child than there are keys in a B-tree node.
- For the best performance, a B-tree is typically organized so that a node holds one block of data.
- If the search criteria involve many keys, a sequential search of all the records in a file may be the most practical approach.

Chapter 11: Hash Tables

Overview

A hash table is a data structure that offers very fast insertion and searching. When you first hear about them, hash tables sound almost too good to be true. No matter how many data items there are, insertion and searching (and sometimes deletion) can take close to constant time: $O(1)$ in Big O notation. In practice this is just a few machine instructions.

For a human user of a hash table this is essentially instantaneous. It's so fast that computer programs typically use hash tables when they need to look up tens of thousands of items in less than a second (as in spelling checkers). Hash tables are significantly faster than trees, which, as we learned in the preceding chapters, operate in relatively fast $O(\log N)$ time. Not only are they fast, hash tables are relatively easy to program.

Hash tables do have several disadvantages. They're based on arrays, and arrays are difficult to expand once they've been created. For some kinds of hash tables, performance may degrade catastrophically when the table becomes too full, so the programmer needs to have a fairly accurate idea of how many data items will need to be stored (or be prepared to periodically transfer data to a larger hash table, a time-consuming process).

Also, there's no convenient way to visit the items in a hash table in any kind of order

(such as from smallest to largest). If you need this capability, you'll need to look elsewhere.

However, if you don't need to visit items in order, and you can predict in advance the size of your database, hash tables are unparalleled in speed and convenience.

Introduction to Hashing

In this section we'll introduce hash tables and hashing. One important concept is how a range of key values is transformed into a range of array index values. In a hash table this is accomplished with a hash function. However, for certain kinds of keys, no hash function is necessary; the key values can be used directly as array indices. We'll look at this simpler situation first and then go on to show how hash functions can be used when keys aren't distributed in such an orderly fashion.

Employee Numbers as Keys

Suppose you're writing a program to access employee records for a small company with, say, 1,000 employees. Each employee record requires 1,000 bytes of storage. Thus you can store the entire database in only 1 megabyte, which will easily fit in your computer's memory.

The company's personnel director has specified that she wants the fastest possible access to any individual record. Also, every employee has been given a number from 1 (for the founder) to 1,000 (for the most recently hired worker). These employee numbers can be used as keys to access the records; in fact, access by other keys is deemed unnecessary. Employees are seldom laid off, but even when they are, their record remains in the database for reference (concerning retirement benefits and so on). What sort of data structure should you use in this situation?

Keys Are Index Numbers

One possibility is a simple array. Each employee record occupies one cell of the array, and the index number of the cell is the employee number for that record. This is shown in Figure 11.1.



Figure 11.1: Employee numbers as array indices

As you know, accessing a specified array element is very fast if you know its index number. The clerk looking up Herman Alcaraz knows that he is employee number 72, so he enters that number, and the program goes instantly to index number 72 in the array. A single program statement is all that's necessary:

```
empRecord rec = databaseArray[72];
```

It's also very quick to add a new item: You insert it just past the last occupied element. The next new record—for Jim Chan, the newly hired employee number 1,001—would go in cell 1,001. Again, a single statement inserts the new record:

```
databaseArray[totalEmployees++] = newRecord;
```

Presumably the array is made somewhat larger than the current number of employees, to allow room for expansion; but not much expansion is anticipated.

Not Always So Orderly

The speed and simplicity of data access using this array-based database make it very attractive. However, it works in our example only because the keys are unusually well organized. They run sequentially from 1 to a known maximum, and this maximum is a reasonable size for an array. There are no deletions, so memory-wasting gaps don't develop in the sequence. New items can be added sequentially at the end of the array, and the array doesn't need to be very much larger than the current number of items.

A Dictionary

In many situations the keys are not so well behaved as in the employee database just described. The classic example is a dictionary. If you want to put every word of an English-language dictionary, from *a* to *zyzzyva* (yes, it's a word), into your computer's memory, so they can be accessed quickly, a hash table is a good choice.

A similar widely used application for hash tables is in computer-language compilers, which maintain a *symbol table* in a hash table. The symbol table holds all the variable and function names made up by the programmer, along with the addresses where they can be found in memory. The program needs to access these names very quickly, so a hash table is the preferred data structure.

Let's say we want to store a 50,000-word English-language dictionary in main memory. You would like every word to occupy its own cell in a 50,000-cell array, so you can access the word using an index number. This will make access very fast. But what's the relationship of these index numbers to the words? Given the word *morphosis*, for example, how do we find its index number?

Converting Words to Numbers

What we need is a system for turning a word into an appropriate index number. To begin, we know that computers use various schemes for representing individual characters as numbers. One such scheme is the ASCII code, in which *a* is 97, *b* is 98, and so on, up to 122 for *z*.

However, the ASCII code runs from 0 to 255, to accommodate capitals, punctuation, and so on. There are really only 26 letters in English words, so let's devise our own code—a simpler one that can potentially save memory space. Let's say *a* is 1, *b* is 2, *c* is 3, and so on up to 26 for *z*. We'll also say a blank is 0, so we have 27 characters. (Uppercase letters aren't used in this dictionary.)

How do we combine the digits from individual letters into a number that represents an entire word? There are all sorts of approaches. We'll look at two representative ones, and their advantages and disadvantages.

Add the Digits

A simple approach to converting a word to a number might be to simply add the code numbers for each character. Say we want to convert the word *cats* to a number. First we convert the characters to digits using our homemade code:

c = 3

a = 1
t = 20
s = 19

Then we add them:

$$3 + 1 + 20 + 19 = 43$$

Thus in our dictionary the word *cats* would be stored in the array cell with index 43. All the other English words would likewise be assigned an array index calculated by this process.

How well would this work? For the sake of argument, let's restrict ourselves to 10-letter words. Then (remembering that a blank is 0), the first word in the dictionary, *a*, would be coded by

$$0 + 0 + 0 + 0 + 0 + 0 + 0 + 0 + 0 + 1 = 1$$

The last potential word in the dictionary would be *zzzzzzzzzz* (ten Zs). Our code obtained by adding its letters would be

$$26 + 26 + 26 + 26 + 26 + 26 + 26 + 26 + 26 + 26 = 260$$

Thus the total range of word codes is from 1 to 260. Unfortunately, there are 50,000 words in the dictionary, so there aren't enough index numbers to go around. Each array element will need to hold about 192 words (50,000 divided by 260).

Clearly this presents problems if we're thinking in terms of our one word-per-array element scheme. Maybe we could put a subarray or linked list of words at each array element. However, this would seriously degrade the access speed. It would be quick to access the array element, but slow to search through the 192 words to find the one we wanted.

So our first attempt at converting words to numbers leaves something to be desired. Too many words have the same index. (For example, *was*, *tin*, *give*, *tend*, *moan*, *tick*, *bails*, *dredge*, and hundreds of other words add to 43, as *cats* does.) We conclude that this approach doesn't discriminate enough, so the resulting array has too few elements. We need to spread out the range of possible indices.

Multiply by Powers

Let's try a different way to map words to numbers. If our array was too small before, let's make sure it's big enough. What would happen if we created an array in which every word, in fact every potential word, from *a* to *zzzzzzzzzz*, was guaranteed to occupy its own unique array element?

To do this, we need to be sure that every character in a word contributes in a unique way to the final number.

We'll begin by thinking about an analogous situation with numbers instead of words. Recall that in an ordinary multi-digit number, each digit position represents a value 10 times as big as the position to its right. Thus 7,546 really means

$$7*1000 + 5*100 + 4*10 + 6*1$$

Or, writing the multipliers as powers of 10:

$$7*10^3 + 5*10^2 + 4*10^1 + 6*10^0$$

(An input routine in a computer program performs a similar series of multiplications and additions to convert a sequence of digits, entered at the keyboard, into a number stored in memory.)

In this system we break a number into its digits, multiply them by appropriate powers of 10 (because there are 10 possible digits), and add the products.

In a similar way we can decompose a word into its letters, convert the letters to their numerical equivalents, multiply them by appropriate powers of 27 (because there are 27 possible characters, including the blank), and add the results. This gives a unique number for every word.

Say we want to convert the word *cats* to a number. We convert the digits to numbers as shown earlier. Then we multiply each number by the appropriate power of 27, and add the results:

$$3*27^3 + 1*27^2 + 20*27^1 + 19*27^0$$

Calculating the powers gives

$$3*19,683 + 1*729 + 20*27 + 19*1$$

and multiplying the letter codes times the powers yields

$$59,049 + 729 + 540 + 19$$

which sums to 60,337.

This process does indeed generate a unique number for every potential word. We just calculated a four-letter word. What happens with larger words? Unfortunately the range of numbers becomes rather large. The largest 10-letter word, *zzzzzzzzzz*, translates into

$$26*27^9 + 26*27^8 + 26*27^7 + 26*27^6 + 26*27^5 + 26*27^4 + 26*27^3 + 26*27^2 + 26*27^1 + 26*27^0$$

Just by itself, 27^9 is more than 7,000,000,000,000, so you can see that the sum will be huge. An array stored in memory can't possibly have this many elements.

The problem is that this scheme assigns an array element to every potential word, whether it's an actual English word or not. Thus there are cells for *aaaaaaaaaa*, *aaaaaaaaab*, *aaaaaaaaac*, and so on, up to *zzzzzzzzzz*. Only a small fraction of these are necessary for real words, so most array cells are empty. This is shown in Figure 11.2.

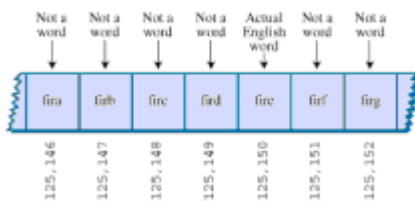

Figure 11.2: Index for every potential

Our first scheme—adding the numbers—generated too few indices. This latest scheme—

adding the numbers times powers of 27—generates too many.

Hashing

What we need is a way to compress the huge range of numbers we obtain from the numbers-multiplied-by-powers system into a range that matches a reasonably sized array.

How big an array are we talking about for our English dictionary? If we only have 50,000 words, you might assume our array should have approximately this many elements. However, it turns out we're going to need an array with about twice this many cells. (It will become clear later why this is so.) So we need an array with 100,000 elements.

Thus we look for a way to squeeze a range of 0 to more than 7,000,000,000,000 into the range 0 to 100,000. A simple approach is to use the modulo operator (%), which finds the remainder when one number is divided by another.

To see how this works, let's look at a smaller and more comprehensible range. Suppose we squeeze numbers in the range 0 to 199 (we'll represent them by the variable `largeNumber`) into the range 0 to 9 (the variable `smallNumber`). There are 10 numbers in the range of small numbers, so we'll say that a variable `smallRange` has the value 10. It doesn't really matter what the large range is (unless it overflows the program's variable size). The Java expression for the conversion is

```
smallNumber = largeNumber % smallRange;
```

The remainders when any number is divided by 10 are always in the range 0 to 9; for example, $13\%10$ gives 3, and $157\%10$ is 7. This is shown in Figure 11.3. We've squeezed the range 0–199 into the range 0–9, a 20-to-1 compression ratio.

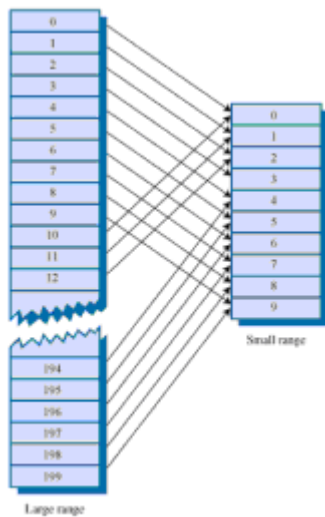

Figure 11.3: Range conversion

A similar expression can be used to compress the really huge numbers that uniquely represent every English word into index numbers that fit in our dictionary array:

```
arrayIndex = hugeNumber % arraySize;
```

This is an example of a *hash function*. It *hashes* (converts) a number in a large range into a number in a smaller range. This smaller range corresponds to the index numbers in an array. An array into which data is inserted using a hash function is called a *hash table*.

(We'll talk more about the design of [hash functions](#) later in the chapter.)

To review: We convert a word into a huge number by multiplying each character in the word by an appropriate power of 27. $hugeNumber = ch0*27^9 + ch1*27^8 + ch2*27^7 + ch3*27^6 + ch4*27^5 + ch5*27^4 + ch6*27^3 + ch7*27^2 + ch8*27^1 + ch9*27^0$

Then, using the modulo (%) operator, we squeeze the resulting huge range of numbers into a range about twice as big as the number of items we want to store. This is an example of a hash function:

```
arraySize = numberWords * 2;
arrayIndex = hugeNumber % arraySize;
```

In the huge range, each number represents a potential data item (an arrangement of letters), but few of these numbers represent actual data items (English words). A hash function transforms these large numbers into the index numbers of a much smaller array. In this array we expect that, on the average, there will be one word for every two cells. Some cells will have no words, and some more than one.

A practical implementation of this scheme runs into trouble because `hugeNumber` will probably overflow its variable size, even for type `long`. We'll see how to deal with this later.

Collisions

We pay a price for squeezing a large range into a small one. There's no longer a guarantee that two words won't hash to the same array index.

This is similar to what happened when we added the letter codes, but the situation is nowhere near as bad. When we added the letters, there were only 260 possible results (for words up to 10 letters). Now we're spreading this out into 50,000 possible results.

Even so, it's impossible to avoid hashing several different words into the same array location, at least occasionally. We'd hoped that we could have one data item per index number, but this turns out not to be possible. The best we can do is hope that not too many words will hash to the same index.

Perhaps you want to insert the word *melioration* into the array. You hash the word to obtain its index number, but find that the cell at that number is already occupied by the word *demystify*, which happens to hash to the exact same number (for a certain size array). This situation, shown in Figure 11.4, is called a *collision*.

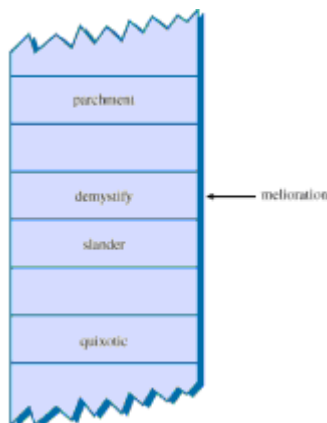

Figure 11.4: Collision

It may appear that the possibility of collisions renders the hashing scheme impractical, but in fact we can work around the problem in a variety of ways.

Remember that we've specified an array with twice as many cells as data items. Thus perhaps half the cells are empty. One approach, when a collision occurs, is to search the array in some systematic way for an empty cell, and insert the new item there, instead of at the index specified by the hash function. This approach is called *open addressing*. If *cats* hashes to 5,421, but this location is already occupied by *parsnip*, then we might try to insert *cats* in 5,422, for example.

A second approach (mentioned earlier) is to create an array that consists of linked lists of words instead of the words themselves. Then when a collision occurs, the new item is simply inserted in the list at that index. This is called *separate chaining*.

In the balance of this chapter we'll discuss open addressing and separate chaining, and then return to the question of hash functions.

Open Addressing

In open addressing, when a data item can't be placed at the index calculated by the hash function, another location in the array is sought. We'll explore three methods of open addressing, which vary in the method used to find the next vacant cell. These methods are *linear probing*, *quadratic probing*, and *double hashing*.

Linear Probing

In linear probing we search sequentially for vacant cells. If 5,421 is occupied when we try to insert *cats* there, we go to 5,422, then 5,423, and so on, incrementing the index until we find an empty cell. This is called linear probing because it steps sequentially along the line of cells.

The Hash Workshop Applet

The Hash Workshop applet demonstrates linear probing. When you start this applet, you'll see a screen similar to Figure 11.5.

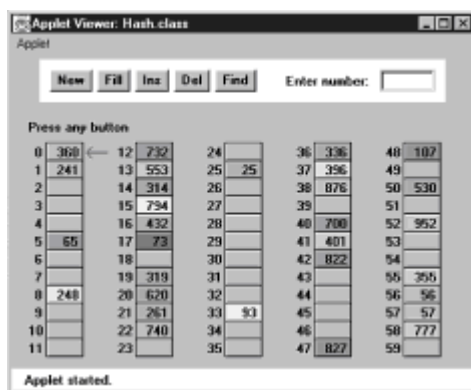

Figure 11.5: The Hash Workshop applet

In this applet the range of keys runs from 0 to 999. The initial size of the array is 60. The hash function has to squeeze the range of keys down to match the array size. It does this with the modulo (%) operator, as we've seen before:

```
arrayIndex = key % arraySize;
```

For the initial array size of 60, this is

```
arrayIndex = key % 60;
```

This hash function is simple enough that you can solve it mentally. For a given key, keep subtracting multiples of 60 until you get a number under 60. For example, to hash 143, subtract 60, giving 83, and then 60 again, giving 23. This is the index number where the algorithm will place 143. Thus you can easily check that the algorithm has hashed a key to the correct address. (An array size of 10 is even easier to figure out, as a key's last digit is the index it will hash to.)

As with other applets, operations are carried out by repeatedly pressing the same button. For example, to find a data item with a specified number, click the Find button repeatedly. Remember, finish a sequence with one button before using another button. For example, don't switch from clicking Fill to some other button until the `Press any key` message is displayed.

All the operations require you to type a numerical value at the beginning of the sequence. The Find button requires you to type a key value, for example, while New requires the size of the new table.

The New Button You can create a new hash table of a size you specify by using the New button. The maximum size is 60; this limitation results from the number of cells Open Addressing that can be viewed in the applet window. The initial size is also 60. We use this number because it makes it easy to check if the hash values are correct, but as we'll see later, in a general-purpose hash table, the array size should be a prime number, so 59 would be a better choice.

The Fill Button Initially the hash table contains 30 items, so it's half full. However, you can also fill it with a specified number of data items using the Fill button. Keep clicking Fill, and when prompted, type the number of items to fill. Hash tables work best when they are not more than half or at the most two-thirds full (40 items in a 60-cell table).

You'll see that the filled cells aren't evenly distributed in the cells. Sometimes there's a sequence of several empty cells, and sometimes a sequence of filled cells.

Let's call a sequence of filled cells in a hash table a *filled sequence*. As you add more and more items, the filled sequences become longer. This is called *clustering*, and is shown in Figure 11.6.

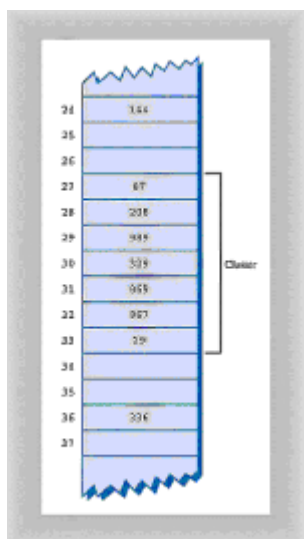

Figure 11.6: Clustering

When you use the applet, note that it may take a long time to fill a hash table if you try to fill it too full (for example, if you try to put 59 items in a 60-cell table). You may think the program has stopped, but be patient. It's extremely inefficient at filling an almost-full array.

Also, note that if the hash table becomes completely full the algorithms all stop working; in this applet they assume that the table has at least one empty cell.

The Find Button The Find button starts by applying the hash function to the key value you type into the number box. This results in an array index. The cell at this index may be the key you're looking for; this is the optimum situation, and success will be reported immediately.

However, it's also possible that this cell is already occupied by a data item with some other key. This is a collision; you'll see the red arrow pointing to an occupied cell. Following a collision, the search algorithm will look at the next cell in sequence. The process of finding an appropriate cell following a collision is called a *probe*.

Following a collision, the Find algorithm simply steps along the array looking at each cell in sequence. If it encounters an empty cell before finding the key it's looking for, it knows the search has failed. There's no use looking further, because the insertion algorithm would have inserted the item at this cell (if not earlier). Figure 11.7 shows successful and unsuccessful linear probes.

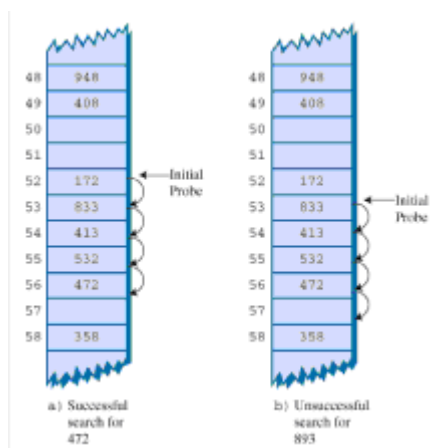

Figure 11.7: Linear probes

The Ins Button The Ins button inserts a data item, with a key value that you type into the number box, into the hash table. It uses the same algorithm as the Find button to locate the appropriate cell. If the original cell is occupied, it will probe linearly for a vacant cell. When it finds one, it inserts the item.

Try inserting some new data items. Type in a 3-digit number and watch what happens. Most items will go into the first cell they try, but some will suffer collisions, and need to step along to find an empty cell. The number of steps they take is the *probe length*. Most probe lengths are only a few cells long. Sometimes, however, you may see probe lengths of 4 or 5 cells, or even longer as the array becomes excessively full.

Notice which keys hash to the same index. If the array size is 60, the keys 7, 67, 127, 187, 247, and so on up to 967 all hash to index 7. Try inserting this sequence or a similar one. This will demonstrate the linear probe.

The Del Button The Del button deletes an item whose key is typed by the user. Deletion isn't accomplished by simply removing a data item from a cell, leaving it empty. Why not? Remember that during insertion the probe process steps along a series of cells, looking for a vacant one. If a cell is made empty in the middle of this sequence of full cells, the Find routine will give up when it sees the empty cell, even if the desired cell can eventually be reached.

For this reason a deleted item is replaced by an item with a special key value that identifies it as deleted. In this applet we assume all legitimate key values are positive, so the deleted value is chosen as `-1`. Deleted items are marked with the special key `*Del*`.

The Insert button will insert a new item at the first available empty cell or in a `*Del*` item. The Find button will treat a `*Del*` item as an existing item for the purposes of searching for another item further along.

If there are many deletions, the hash table fills up with these ersatz `*Del*` data items, which makes it less efficient. For this reason many hash table implementations don't allow deletion. If it is implemented, it should be used sparingly.

Duplicates Allowed?

Can you allow data items with duplicate keys to be used in hash tables? The fill routine in the Hash applet doesn't allow duplicates, but you can insert them with the Insert button if you like. Then you'll see that only the first one can be accessed. The only way to access a second item with the same key is to delete the first one. This isn't too convenient.

You could rewrite the Find algorithm to look for all items with the same key instead of just the first one. However, it would then need to search through all the cells of every linear sequence it encountered. This wastes time for all table accesses, even when no duplicates are involved. In the majority of cases you probably want to forbid duplicates.

Clustering

Try inserting more items into the hash table in the Hash Workshop applet. As it gets more full, clusters grow larger. Clustering can result in very long probe lengths. This means that it's very slow to access cells at the end of the sequence.

The more full the array is, the worse clustering becomes. It's not a problem when the array is half full, and still not too bad when it's two-thirds full. Beyond this, however, performance degrades seriously as the clusters grow larger and larger. For this reason it's critical when designing a hash table to ensure that it never becomes more than half, or at the most two-thirds, full. (We'll discuss the mathematical relationship between how full the hash table is and probe lengths at the end of this chapter.)

Java Code for a Linear Probe Hash Table

It's not hard to create methods to handle search, insertion, and deletion with linear-probe hash tables. We'll show the Java code for these methods, and then a complete `hash.java` program that puts them in context.

The `find()` Method

The `find()` method first calls `hashFunc()` to hash the search key to obtain the index number `hashVal`. The `hashFunc()` method applies the `%` operator to the search key and the array size, as we've seen before.

Next, in a `while` condition, `find()` checks if the item at this index is empty (`null`). If not, it checks if the item contains the search key. If it does, it returns the item. If it doesn't,

`find()` increments `hashVal` and goes back to the top of the `while` loop to check if the next cell is occupied. Here's the code for `find()`:

```
public DataItem find(int key)    // find item with key
// (assumes table not full)
{
    int hashVal = hashFunc(key); // hash the key

    while(hashArray[hashVal] != null) // until empty cell,
    {                                  // found the key?
        if(hashArray[hashVal].iData == key)
            return hashArray[hashVal]; // yes, return item
        ++hashVal;                      // go to next cell
        hashVal %= arraySize;           // wrap around if necessary
    }
    return null;                        // can't find item
}
```

As `hashVal` steps through the array, it eventually reaches the end. When this happens we want it to wrap around to the beginning. We could check for this with an `if` statement, setting `hashVal` to 0 whenever it equaled the array size. However, we can accomplish the same thing by applying the `%` operator to `hashVal` and the array size.

Cautious programmers might not want to assume the table is not full, as is done here. The table should not be allowed to become full, but if it did, this method would loop forever. For simplicity we don't check for this situation.

The `insert()` Method

The `insert()` method uses about the same algorithm as `find()` to locate where a data item should go. However, it's looking for an empty cell or a deleted item (key -1), rather than a specific item. Once this empty cell has been located, `insert()` places the new item into it.

```
public void insert(DataItem item) // insert a DataItem
// (assumes table not full)
{
    int key = item.iData;          // extract key
    int hashVal = hashFunc(key);   // hash the key
    // until empty cell or -1,

    while(hashArray[hashVal] != null &&
           hashArray[hashVal].iData != -1)
    {
        ++hashVal;                // go to next cell
        hashVal %= arraySize;     // wrap around if necessary
    }
    hashArray[hashVal] = item;    // insert item
} // end insert()
```

The `delete()` Method

The `delete()` method finds an existing item using code similar to `find()`. Once the item is found, `delete()` writes over it with the special data item `nonItem`, which is predefined with a key of -1.

```

public DataItem delete(int key) // delete a DataItem
{
    int hashVal = hashFunc(key); // hash the key

    while(hashArray[hashVal] != null) // until empty cell,
    { // found the key?
        if(hashArray[hashVal].iData == key)
        {
            DataItem temp = hashArray[hashVal]; // save item
            hashArray[hashVal] = nonItem; // delete item
            return temp; // return item
        }
        ++hashVal; // go to next cell
        hashVal %= arraySize; // wrap around if necessary
    }
    return null; // can't find item

} // end delete()

```

The hash.java Program

Here's the complete `hash.java` program. A `DataItem` object contains just one field, an integer that is its key. As in other data structures we've discussed, these objects could contain more data, or a reference to an object of another class (such as `employee` or `partNumber`).

The major field in class `HashTable` is an array called `hashArray`. Other fields are the size of the array and the special `nonItem` object used for deletions.

Here's the listing for `hash.java`:

```

// hash.java
// demonstrates hash table with linear probing
// to run this program: C:>java HashTableApp
import java.io.*; // for I/O
import java.util.*; // for Stack class
import java.lang.Integer; // for parseInt()
/////////////////////////////////////////////////////////////////
class DataItem
{ // (could have more data)
    public int iData; // data item (key)

//-----
-
    public DataItem(int ii) // constructor
    { iData = ii; }

//-----
-
} // end class DataItem

/////////////////////////////////////////////////////////////////

```



```

class HashTable
{
    DataItem[] hashArray;           // array holds hash table
    int arraySize;
    DataItem nonItem;              // for deleted items

// -----
-
    public HashTable(int size)      // constructor
    {
        arraySize = size;
        hashArray = new DataItem[arraySize];
        nonItem = new DataItem(-1); // deleted item key is -1
    }

// -----
-
    public void displayTable()
    {
        System.out.print("Table: ");
        for(int j=0; j<arraySize; j++)
        {
            if(hashArray[j] != null)
                System.out.print(hashArray[j].iData+ " ");
            else
                System.out.print("** ");
        }
        System.out.println("");
    }

// -----
-
    public int hashFunc(int key)
    {
        return key % arraySize;     // hash function
    }

// -----
-
    public void insert(DataItem item) // insert a DataItem
    // (assumes table not full)
    {
        int key = item.iData;        // extract key
        int hashVal = hashFunc(key); // hash the key
        // until empty cell or -1,
        while(hashArray[hashVal] != null &&
            hashArray[hashVal].iData != -
1)
        {
            ++hashVal;                // go to next cell
            hashVal %= arraySize;     // wraparound if necessary
        }
        hashArray[hashVal] = item;   // insert item
    } // end insert()

```

```

// -----
-
public DataItem delete(int key) // delete a DataItem
{
    int hashVal = hashFunc(key); // hash the key

    while(hashArray[hashVal] != null) // until empty cell,
    {
        // found the key?
        if(hashArray[hashVal].iData == key)
        {
            DataItem temp = hashArray[hashVal]; // save item
            hashArray[hashVal] = nonItem; // delete item
            return temp; // return item
        }
        ++hashVal; // go to next cell
        hashVal %= arraySize; // wraparound if necessary
    }
    return null; // can't find item
} // end delete()

// -----
-
public DataItem find(int key) // find item with key
{
    int hashVal = hashFunc(key); // hash the key

    while(hashArray[hashVal] != null) // until empty cell,
    {
        // found the key?
        if(hashArray[hashVal].iData == key)
            return hashArray[hashVal]; // yes, return item
        ++hashVal; // go to next cell
        hashVal %= arraySize; // wraparound if necessary
    }
    return null; // can't find item
}

// -----
-
} // end class HashTable

////////////////////////////////////

class HashTableApp
{
    public static void main(String[] args) throws IOException
    {
        DataItem aDataItem;
        int aKey, size, n, keysPerCell;

        // get sizes
        putText("Enter size of hash table: ");
        size = getInt();
        putText("Enter initial number of items: ");
    }
}

```

```

n = getInt();
keysPerCell = 10;

// make table
HashTable theHashTable = new HashTable(size);

for(int j=0; j<n; j++) // insert data
{
    aKey = (int)(java.lang.Math.random() *
                keysPerCell * size);
    aDataItem = new DataItem(aKey);
    theHashTable.insert(aDataItem);
}

while(true) // interact with user
{
    putText("Enter first letter of ");
    putText("show, insert, delete, or find: ");
    char choice = getChar();
    switch(choice)
    {
        case 's':
            theHashTable.displayTable();
            break;
        case 'i':
            putText("Enter key value to insert: ");
            aKey = getInt();
            aDataItem = new DataItem(aKey);
            theHashTable.insert(aDataItem);
            break;
        case 'd':
            putText("Enter key value to delete: ");
            aKey = getInt();
            theHashTable.delete(aKey);
            break;
        case 'f':
            putText("Enter key value to find: ");
            aKey = getInt();
            aDataItem = theHashTable.find(aKey);
            if(aDataItem != null)
            {
                System.out.println("Found " + aKey);
            }
            else
                System.out.println("Could not find " + aKey);
            break;
        default:
            putText("Invalid entry\n");
    } // end switch
} // end while
} // end main()

```

```

//-----
-

```

```

    public static void putText(String s)
    {
        System.out.print(s);
        System.out.flush();
    }

//-----
-
    public static String getString() throws IOException
    {
        InputStreamReader isr = new InputStreamReader(System.in);
        BufferedReader br = new BufferedReader(isr);
        String s = br.readLine();
        return s;
    }

//-----
-
    public static char getChar() throws IOException
    {
        String s = getString();
        return s.charAt(0);
    }

//-----
    public static int getInt() throws IOException
    {
        String s = getString();
        return Integer.parseInt(s);
    }

//-----
-
    } // end class HashTableApp

```

The `main()` routine in the `HashTableApp` class contains a user interface that allows the user to show the contents of the hash table (enter `s`), insert an item (`i`), delete an item (`d`), or find an item (`f`).

Initially, it asks the user to input the size of the hash table and the number of items in it. You can make it almost any size, from a few items to 10,000. (It may take a little time to build larger tables than this.) Don't use the `s` (for show) option on tables of more than a few hundred items; they scroll off the screen and it takes a long time to display them.

A variable in `main()`, `keysPerCell`, specifies the ratio of the range of keys to the size of the array. In the listing, it's set to 10. This means that if you specify a table size of 20, the keys will range from 0 to 200.

To see what's going on, it's best to create tables with fewer than about 20 items, so all the items can be displayed on one line. Here's some sample interaction with `hash.java`:

```

Enter size of hash table: 12
Enter initial number of items: 8

Enter first letter of show, insert, delete, or find: s

```

```
Table: 108 13 0 ** ** 113 5 66 ** 117 ** 47
```

```
Enter first letter of show, insert, delete, or find: f  
Enter key value to find: 66  
Found 66
```

```
Enter first letter of show, insert, delete, or find: i  
Enter key value to insert: 100  
Enter first letter of show, insert, delete, or find: s  
Table: 108 13 0 ** 100 113 5 66 ** 117 ** 47
```

```
Enter first letter of show, insert, delete, or find: d  
Enter key value to delete: 100  
Enter first letter of show, insert, delete, or find: s  
Table: 108 13 0 ** -1 113 5 66 ** 117 ** 47
```

Key values run from 0 to 119 (12 times 10, minus 1). The `**` symbol indicates that a cell is empty. The item with key 100 is inserted at location 4 (the first item is numbered 0) because $100\%12$ is 4. Notice how 100 changes to -1 when this item is deleted.

Expanding the Array

One option when a hash table becomes too full is to expand its array. In Java, arrays have a fixed size and can't be expanded. Your program could create a new, larger array, and then rehash the contents of the old small array into the new large one. However, this is a time-consuming process.

Remember that the hash function calculates the location of a given data item based on the array size, so the locations in the large array won't be the same as those in a small array. You can't, therefore, simply copy the items from one array to the other. You'll need to go through the old array in sequence, inserting each item into the new array with the `insert()` method.

Java offers a class `Vector` that is an array-like data structure that can be expanded. However, it's not much help because of the need to rehash all data items when the table changes size. Expanding the array is only practical when there's plenty of time available to carry it out.

Quadratic Probing

We've seen that clusters can occur in the linear probe approach to open addressing. Once a cluster forms, it tends to grow larger. Items that hash to any value in the range of the cluster will step along and insert themselves at the end of the cluster, thus making it even bigger. The bigger the cluster gets, the faster it grows.

It's like the crowd that gathers when someone faints at the shopping mall. The first arrivals come because they saw the victim fall; later arrivals gather because they wondered what everyone else was looking at. The larger the crowd grows, the more people are attracted to it.

The ratio of the number of items in a table, to the table's size, is called the *load factor*. A table with 10,000 cells and 6,667 items has a load factor of $2/3$.

```
loadFactor = nItems / arraySize;
```

Clusters can form even when the load factor isn't high. Parts of the hash table may consist of big clusters, while others are sparsely inhabited. Clusters reduce performance.

Quadratic probing is an attempt to keep clusters from forming. The idea is to probe more widely separated cells, instead of those adjacent to the primary hash site.

The Step Is the Square of the Step Number

In a linear probe, if the primary hash index is x , subsequent probes go to $x+1$, $x+2$, $x+3$, and so on. In quadratic probing, probes go to $x+1$, $x+4$, $x+9$, $x+16$, $x+25$, and so on. The distance from the initial probe is the square of the step number: $x+1^2$, $x+2^2$, $x+3^2$, $x+4^2$, $x+5^2$, and so on.

Figure 11.8 shows some quadratic probes.

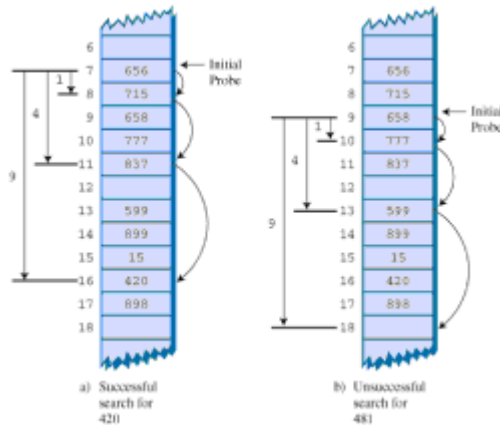

Figure 11.8: Quadratic probes

It's as if a quadratic probe became increasingly desperate as its search lengthened. At first it calmly picks the adjacent cell. If that's occupied, it thinks it may be in a small cluster so it tries something 4 cells away. If that's occupied it becomes a little concerned, thinking it may be in a larger cluster, and tries 9 cells away. If that's occupied it feels the first tinges of panic and jumps 16 cells away. Pretty soon it's flying hysterically all over the place, as you can see if you try searching with the HashDouble Workshop applet when the table is almost full.

The HashDouble Applet with Quadratic Probes

The HashDouble Workshop applet allows two different kinds of collision handling: quadratic probes and double hashing. (We'll look at double hashing in the next section.) This applet generates a display much like that of the Hash Workshop applet, except that it includes radio buttons to select quadratic probing or double hashing.

To see how quadratic probes look, start up this applet and create a new hash table of 59 items using the New button. When you're asked to select double or quadratic probe, click the Quad button. Once the new table is created, fill it four-fifths full using the Fill button (47 items in a 59-cell array). This is too full, but it will generate longer probes so you can study the probe algorithm.

Incidentally, if you try to fill the hash table too full, you may see the message `Can't complete fill`. This occurs when the probe sequences get very long. Every additional step in the probe sequence makes a bigger step size. If the sequence is too long, the step size will eventually exceed the capacity of its integer variable, so the applet shuts down the fill process before this happens.

Once the table is filled, select an existing key value and use the Find key to see if the

algorithm can find it. Often it's located at the initial cell, or the one adjacent to it. If you're patient, however, you'll find a key that requires three or four steps, and you'll see the step size lengthen for each step. You can also use Find to search for a nonexistent key; this search continues until an empty cell is encountered.

Important: Always make the array size a prime number. Use 59 instead of 60, for example. (Other primes less than 60 are 53, 47, 43, 41, 37, 31, 29, 23, 19, 17, 13, 11, 7, 5, 3, and 2.) If the array size is not prime, an endless sequence of steps may occur during a probe. If this happens during a Fill operation, the applet will be paralyzed.

The Problem with Quadratic Probes

Quadratic probes eliminate the clustering problem we saw with the linear probe, which is called *primary clustering*. However, quadratic probes suffer from a different and more subtle clustering problem. This occurs because all the keys that hash to a particular cell follow the same sequence in trying to find a vacant space.

Let's say 184, 302, 420, 544 all hash to 7 and are inserted in this order. Then 302 will require a one-step probe, 420 will require a 2-step probe, and 544 will require a 3-step probe. Each additional item with a key that hashes to 7 will require a longer probe. This phenomenon is called *secondary clustering*.

Secondary clustering is not a serious problem, but quadratic probing is not often used because there's a slightly better solution.

Double Hashing

To eliminate secondary clustering as well as primary clustering, another approach can be used: *double hashing* (sometimes called rehashing). Secondary clustering occurs because the algorithm that generates the sequence of steps in the quadratic probe always generates the same steps: 1, 4, 9, 16, and so on.

What we need is a way to generate probe sequences that depend on the key instead of being the same for every key. Then numbers with different keys that hash to the same index will use different probe sequences.

The solution is to hash the key a second time, using a different hash function, and use the result as the step size. For a given key the step size remains constant throughout a probe, but it's different for different keys.

Experience has shown that this secondary hash function must have certain characteristics:

- It must not be the same as the primary hash function.
- It must never output a 0 (otherwise there would be no step; every probe would land on the same cell, and the algorithm would go into an endless loop).

Experts have discovered that functions of the following form work well:

```
stepSize = constant - (key % constant);
```

where `constant` is prime and smaller than the array size. For example,

```
stepSize = 5 - (key % 5);
```

This is the secondary hash function used in the Workshop applet. For any given key all the steps will be the same size, but different keys generate different step sizes. With this

hash function the step sizes are all in the range 1 to 5. This is shown in Figure 11.9.

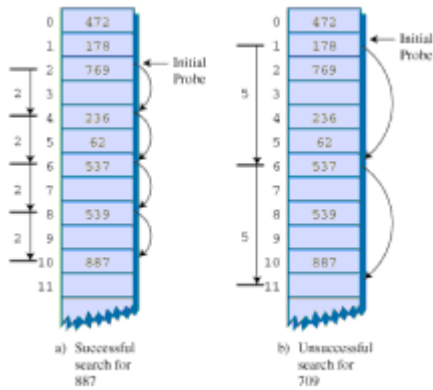

Figure 11.9: Double hashing

The HashDouble Applet with Double Hashing

You can use the HashDouble Workshop applet to see how double hashing works. It starts up automatically in Double-hashing mode, but if it's in Quadratic mode you can switch to Double by creating a new table with the New button and clicking the Double button when prompted. To best see probes at work you'll need to fill the table rather full; say to about nine-tenths capacity or more. Even with such high load factors, most data items will be found in the cell found by the first hash function; only a few will require extended probe sequences.

Try finding existing keys. When one needs a probe sequence, you'll see how all the steps are the same size for a given key, but that the step size is different—between 1 and 5—for different keys.

Java Code for Double Hashing

Here's the listing for `hashDouble.java`, which uses double hashing. It's similar to the `hash.java` program, but uses two hash functions, one for finding the initial index, and the second for generating the step size. As before, the user can show the table contents, insert an item, delete an item, and find an item.

```
// hashDouble.java
// demonstrates hash table with double hashing
// to run this program: C:>java HashDoubleApp
import java.io.*;                // for I/O
import java.util.*;              // for Stack class
import java.lang.Integer;        // for parseInt()
////////////////////////////////////
class DataItem
{
    // (could have more items)
    public int iData;             // data item (key)

//-----
-
    public DataItem(int ii)      // constructor
    { iData = ii; }

//-----
-
}
```



```

    } // end class DataItem

////////////////////////////////////

class HashTable
{
    DataItem[] hashArray;           // array is the hash table
    int arraySize;
    DataItem nonItem;              // for deleted items

// -----
-
    HashTable(int size)            // constructor
    {
        arraySize = size;
        hashArray = new DataItem[arraySize];
        nonItem = new DataItem(-1);
    }

// -----
-
    public void displayTable()
    {
        System.out.print("Table: ");
        for(int j=0; j<arraySize; j++)
        {
            if(hashArray[j] != null)
                System.out.print(hashArray[j].iData+ " ");
            else
                System.out.print("** ");
        }
        System.out.println("");
    }

// -----
-
    public int hashFunc1(int key)
    {
        return key % arraySize;
    }

// -----
-
    public int hashFunc2(int key)
    {
        // non-zero, less than array size, different from hF1
        // array size must be relatively prime to 5, 4, 3, and 2
        return 5 - key % 5;
    }

// -----
-
                                     // insert a DataItem
    public void insert(int key, DataItem item)

```

```

// (assumes table not full)
{
int hashVal = hashFunc1(key); // hash the key
int stepSize = hashFunc2(key); // get step size
// until empty cell or -1
while(hashArray[hashVal] != null &&
1)           hashArray[hashVal].iData != -
{
hashVal += stepSize; // add the step
hashVal %= arraySize; // for wraparound
}
hashArray[hashVal] = item; // insert item
} // end insert()

// -----
-
public DataItem delete(int key) // delete a DataItem
{
int hashVal = hashFunc1(key); // hash the key
int stepSize = hashFunc2(key); // get step size

while(hashArray[hashVal] != null) // until empty cell,
{ // is correct hashVal?
if(hashArray[hashVal].iData == key)
{
DataItem temp = hashArray[hashVal]; // save item
hashArray[hashVal] = nonItem; // delete item
return temp; // return item
}
hashVal += stepSize; // add the step
hashVal %= arraySize; // for wraparound
}
return null; // can't find item
} // end delete()

// -----
-
public DataItem find(int key) // find item with key
// (assumes table not full)
{
int hashVal = hashFunc1(key); // hash the key
int stepSize = hashFunc2(key); // get step size

while(hashArray[hashVal] != null) // until empty cell,
{ // is correct hashVal?
if(hashArray[hashVal].iData == key)
return hashArray[hashVal]; // yes, return item
hashVal += stepSize; // add the step
hashVal %= arraySize; // for wraparound
}
return null; // can't find item
}

```

```

// -----
-
    } // end class HashTable

////////////////////////////////////

class HashDoubleApp
{
    public static void main(String[] args) throws IOException
    {
        int aKey;
        DataItem aDataItem;
        int size, n;

                                // get sizes
        putText("Enter size of hash table: ");
        size = getInt();
        putText("Enter initial number of items: ");
        n = getInt();

                                // make table
        HashTable theHashTable = new HashTable(size);

        for(int j=0; j<n; j++)      // insert data
        {
            aKey = (int)(java.lang.Math.random() * 2 * size);
            aDataItem = new DataItem(aKey);
            theHashTable.insert(aKey, aDataItem);
        }

        while(true)                // interact with user
        {
            putText("Enter first letter of ");
            putText("show, insert, delete, or find: ");
            char choice = getChar();
            switch(choice)
            {
                case 's':
                    theHashTable.displayTable();
                    break;
                case 'i':
                    putText("Enter key value to insert: ");
                    aKey = getInt();
                    aDataItem = new DataItem(aKey);
                    theHashTable.insert(aKey, aDataItem);
                    break;
                case 'd':
                    putText("Enter key value to delete: ");
                    aKey = getInt();
                    theHashTable.delete(aKey);
                    break;
                case 'f':
                    putText("Enter key value to find: ");
                    aKey = getInt();
            }
        }
    }
}

```

```

        aDataItem = theHashTable.find(aKey);
        if(aDataItem != null)
            System.out.println("Found " + aKey);
        else
            System.out.println("Could not find " + aKey);
        break;
    default:
        putText("Invalid entry\n");
    } // end switch
} // end while
} // end main()

//-----
-
    public static void putText(String s)
    {
        System.out.print(s);
        System.out.flush();
    }

//-----
-
    public static String getString() throws IOException
    {
        InputStreamReader isr = new InputStreamReader(System.in);
        BufferedReader br = new BufferedReader(isr);
        String s = br.readLine();
        return s;
    }

//-----
-
    public static char getChar() throws IOException
    {
        String s = getString();
        return s.charAt(0);
    }

//-----
-
    public static int getInt() throws IOException
    {
        String s = getString();
        return Integer.parseInt(s);
    }

//-----
-

} // end class HashDoubleApp

```

Output and operation of this program are similar to those of `hash.java`. Table 11.1 shows what happens when 21 items are inserted into a 23-cell hash table using double hashing. The step sizes run from 1 to 5.

Table 11.1: Filling a 23-Cell Table Using Double Hashing

Item Number	Key	Hash Value	Step Size	Cells in Probe Sequence
1	1	1	4	
2	38	15	2	
3	37	14	3	
4	16	16	4	
5	20	20	5	
6	3	3	2	
7	11	11	4	
8	24	1	1	2
9	5	5	5	
10	16	16	4	20 1 5 9
11	10	10	5	
12	31	8	4	
13	18	18	2	
14	12	12	3	
15	30	7	5	
16	1	1	4	5 9 13
17	19	19	1	
18	36	13	4	17
19	41	18	4	22
20	15	15	5	20 2 7 12 17 22 4
21	25	2	5	7 12 17 22 4 9 14 19 1 6

The first 15 keys mostly hash to a vacant cell (the 10th one is an anomaly). After that, as the array gets more full, the probe sequences become quite long. Here's the resulting array of keys:

```
** 1 24 3 15 5 25 30 31 16 10 11 12 1 37 38 16 36 18 19 20 ** 41
```

Table Size a Prime Number

Double hashing requires that the size of the hash table is a prime number. To see why, imagine a situation where the table size is not a prime number. For example, suppose the array size is 15 (indices from 0 to 14), and that a particular key hashes to an initial index of 0 and a step size of 5. The probe sequence will be 0, 5, 10, 0, 5, 10, and so on, repeating endlessly. Only these three cells are ever examined, so the algorithm will never find the empty cells that might be waiting at 1, 2, 3, and so on. The algorithm will crash and burn.

If the array size were 13, which is prime, the probe sequence eventually visits every cell. It's 0, 5, 10, 2, 7, 12, 4, 9, 1, 6, 11, 3, and so on and on. If there is even one empty cell, the probe will find it. Using a prime number as the array size makes it impossible for any number to divide it evenly, so the probe sequence will eventually check every cell.

A similar effect occurs using the quadratic probe. In that case, however, the step size gets larger with each step, and will eventually overflow the variable holding it, thus preventing an endless loop.

In general, double hashing is the probe sequence of choice when open addressing is used.

Separate Chaining

In open addressing, collisions are resolved by looking for an open cell in the hash table. A different approach is to install a linked list at each index in the hash table. A data item's key is hashed to the index in the usual way, and the item is inserted into the linked list at that index. Other items that hash to the same index are simply added to the linked list; there's no need to search for empty cells in the primary array. Figure 11.10 shows how separate chaining looks.

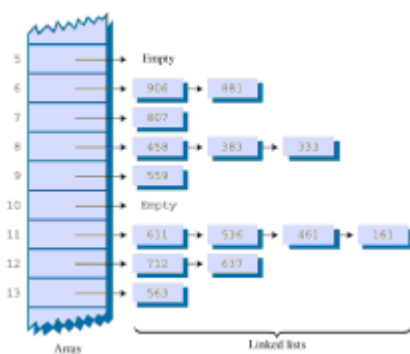

Figure 11.10: eparate chaining

Separate chaining is conceptually somewhat simpler than the various probe schemes used in open addressing. However, the code is longer because it must include the mechanism for the linked lists, usually in the form of an additional class.

The HashChain Workshop Applet

To see how separate chaining works, start the HashChain Workshop applet. It displays an array of linked lists, as shown in Figure 11.11.

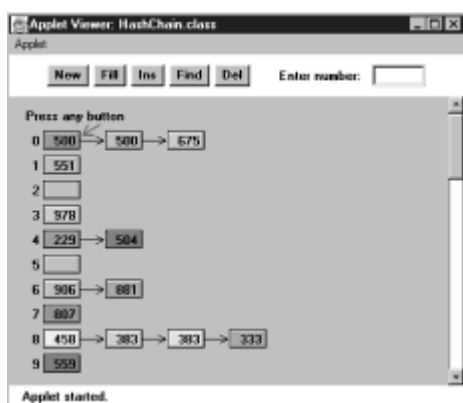

Figure 11.11: The HashChain Workshop applet

Each element of the array occupies one line of the display, and the linked lists extend from left to right. Initially there are 25 cells in the array (25 lists). This is more than fits on the screen; you can move the display up and down with the scrollbar to see the entire array. The display shows up to six items per list. You can create a hash table with up to 100 lists, and use load factors up to 2.0. Higher load factors may cause the linked lists to exceed six items and run off the right edge of the screen, making it impossible to see all the items. (This may happen very occasionally even at the 2.0 load factor.)

Experiment with the HashChain applet by inserting some new items with the Ins button. You'll see how the red arrow goes immediately to the correct list and inserts the item at the beginning of the list. The lists in the HashChain applet are not sorted, so insertion does not require searching through the list. (The example program will demonstrate sorted lists.)

Try to find specified items using the Find button. During a Find operation, if there are several items on the list, the red arrow must step through the items looking for the correct one. For a successful search, half the items in the list must be examined on the average, as we discussed in [Chapter 5, "Linked Lists."](#) For an unsuccessful search all the items must be examined.

Load Factors

The load factor (the ratio of the number of items in a hash table to its size) is typically different in separate chaining than in open addressing. In separate chaining it's normal to put N or more items into an N -cell array; thus the load factor can be 1 or greater. There's no problem with this; some locations will simply contain two or more items in their lists.

Of course, if there are many items on the lists, access time is reduced because access to a specified item requires searching through an average of half the items on the list. Finding the initial cell takes fast $O(1)$ time, but searching through a list takes time proportional to the number of items on the list; $O(M)$ time. Thus we don't want the lists to become too full.

A load factor of 1, as shown in the Workshop applet, is common. With this load factor, roughly one third of the cells will be empty, one third will hold one item, and one third will hold two or more items.

In open addressing, performance degrades badly as the load factor increases above one half or two thirds. In separate chaining the load factor can rise above 1 without hurting performance very much. This makes separate chaining a more robust mechanism,

especially when it's hard to predict in advance how much data will be placed in the hash table.

Duplicates

Duplicates are allowed and may be generated in the Fill process. All items with the same key will be inserted in the same list, so if you need to discover all of them, you must search the entire list in both successful and unsuccessful searches. This lowers performance. The Find operation in the applet only finds the first of several duplicates.

Deletion

In separate chaining, deletion poses no special problems as it does in open addressing. The algorithm hashes to the proper list and then deletes the item from the list. Because probes aren't used, it doesn't matter if the list at a particular cell becomes empty. We've included a Del button in the Workshop applet to show how deletion works.

Table Size

With separate chaining it's not so important to make the table size a prime number, as it is with quadratic probes and double hashing. There are no probes in separate chaining, so there's no need to worry that a probe will go into an endless sequence because the step size divides evenly into the array size.

On the other hand, certain kinds of key distributions can cause data to cluster when the array size is not a prime number. We'll have more to say about this when we discuss hash functions.

Buckets

Another approach similar to separate chaining is to use an array at each location in the hash table, instead of a linked list. Such arrays are called *buckets*. This approach is not as efficient as the linked list approach, however, because of the problem of choosing the size of the buckets. If they're too small they may overflow, and if they're too large they waste memory. Linked lists, which allocate memory dynamically, don't have this problem.

Java Code for Separate Chaining

The `hashChain.java` program includes a `SortedList` class and an associated `Link` class. Sorted lists don't speed up a successful search, but they do cut the time of an unsuccessful search in half. (As soon as an item larger than the search key is reached, which on average is half the items in a list, the search is declared a failure.)

Deletion times are also cut in half; however, insertion times are lengthened, because the new item can't just be inserted at the beginning of the list; its proper place in the ordered list must be located before it's inserted. If the lists are short, the increase in insertion times may not be important.

In situations where many unsuccessful searches are anticipated, it may be worthwhile to use the slightly more complicated sorted list, rather than an unsorted list. However, an unsorted list is preferred if insertion speed is more important.

The `hashChain.java` program, shown in Listing 11.1, begins by constructing a hash table with a table size and number of items entered by the user. The user can then insert, find, and delete items, and display the list. For the entire hash table to be viewed on the screen, the size of the table must be no greater than 16 or so.

Listing 11.1 The `hashChain.java` Program

```

// hashChain.java
// demonstrates hash table with separate chaining
// to run this program: C:>java HashChainApp
import java.io.*;                // for I/O
import java.util.*;              // for Stack class
import java.lang.Integer;        // for parseInt()
////////////////////////////////////
class Link
{
    // (could be other
items)
    public int iData;             // data item
    public Link next;            // next link in list

// -----
-
    public Link(int it)          // constructor
        { iData= it; }

// -----
-
    public void displayLink()    // display this link
        { System.out.print(iData + " "); }
} // end class Link

////////////////////////////////////
class SortedList
{
    private Link first;          // ref to first list item

// -----
-
    public void SortedList()     // constructor
        { first = null; }

// -----
-
    public void insert(Link theLink) // insert link, in order
    {
        int key = theLink.iData;
        Link previous = null;    // start at first
        Link current = first;

                                // until end of list,
        while(current != null && key > current.iData)
        {
                                // or current > key,
            previous = current;
            current = current.next; // go to next item
        }
        if(previous==null)       // if beginning of list,
            first = theLink;     // first --> new link
        else                      // not at beginning,
            previous.next = theLink; // prev --> new link
        theLink.next = current;  // new link --> current
    } // end insert()
}

```

```

// -----
-
public void delete(int key)      // delete link
{
    // (assumes non-empty
list) Link previous = null;      // start at first
    Link current = first;

    // until end of list,
while(current != null && key != current.iData)
    {
        // or key == current,
        previous = current;
        current = current.next; // go to next link
    }

    // disconnect link
if(previous==null)              // if beginning of list
    first = first.next;         // delete first link
else                             // not at beginning
    previous.next = current.next; // delete current
link
} // end delete()

// -----
-
public Link find(int key)        // find link
{
    Link current = first;       // start at first
    // until end of list,
while(current != null && current.iData <= key)
    {
        // or key too small,
        if(current.iData == key) // is this the link?
            return current;     // found it, return link
        current = current.next; // go to next item
    }
return null;                    // didn't find it
} // end find()

// -----
-
public void displayList()
{
    System.out.print("List (first-->last): ");
    Link current = first;       // start at beginning of list
    while(current != null)      // until end of list,
    {
        current.displayLink(); // print data
        current = current.next; // move to next link
    }
    System.out.println("");
}
} // end class SortedList

```

////////////////////////////////////

```

class HashTable
{
    private SortedList[] hashArray;    // array of lists
    private int arraySize;

// -----
-
    public HashTable(int size)        // constructor
    {
        arraySize = size;
        hashArray = new SortedList[arraySize]; // create array
        for(int j=0; j<arraySize; j++)      // fill array
            hashArray[j] = new SortedList(); // with lists
    }

// -----
-
    public void displayTable()
    {
        for(int j=0; j<arraySize; j++) // for each cell,
        {
            System.out.print(j + ". "); // display cell number
            hashArray[j].displayList(); // display list
        }
    }

// -----
-
    public int hashFunc(int key)      // hash function
    {
        return key % arraySize;
    }

// -----
-
    public void insert(Link theLink) // insert a link
    {
        int key = theLink.iData;
        int hashVal = hashFunc(key); // hash the key
        hashArray[hashVal].insert(theLink); // insert at hashVal
    } // end insert()

// -----
-
    public void delete(int key)      // delete a link
    {
        int hashVal = hashFunc(key); // hash the key
        hashArray[hashVal].delete(key); // delete link
    } // end delete()

// -----
-
    public Link find(int key)        // find link
    {

```

```

        int hashVal = hashFunc(key); // hash the key
        Link theLink = hashArray[hashVal].find(key); // get link
        return theLink; // return link
    }

// -----
-
    } // end class HashTable

////////////////////////////////////

class HashChainApp
{
    public static void main(String[] args) throws IOException
    {
        int aKey;
        Link aDataItem;
        int size, n, keysPerCell = 100;

        // get sizes
        putText("Enter size of hash table: ");
        size = getInt();
        putText("Enter initial number of items: ");
        n = getInt();

        // make table
        HashTable theHashTable = new HashTable(size);

        for(int j=0; j<n; j++) // insert data
        {
            aKey = (int)(java.lang.Math.random() *
                keysPerCell * size);

            aDataItem = new Link(aKey);
            theHashTable.insert(aDataItem);
        }
        while(true) // interact with user
        {
            putText("Enter first letter of ");
            putText("show, insert, delete, or find: ");
            char choice = getChar();
            switch(choice)
            {
                case 's':
                    theHashTable.displayTable();
                    break;
                case 'i':
                    putText("Enter key value to insert: ");
                    aKey = getInt();
                    aDataItem = new Link(aKey);
                    theHashTable.insert(aDataItem);
                    break;
                case 'd':
                    putText("Enter key value to delete: ");
                    aKey = getInt();
                    theHashTable.delete(aKey);
            }
        }
    }
}

```

```

        break;
    case 'f':
        putText("Enter key value to find: ");
        aKey = getInt();
        aDataItem = theHashTable.find(aKey);
        if(aDataItem != null)
            System.out.println("Found " + aKey);
        else
            System.out.println("Could not find " + aKey);
        break;
    default:
        putText("Invalid entry\n");
    } // end switch
} // end while
} // end main()

//-----
-
public static void putText(String s)
{
    System.out.print(s);
    System.out.flush();
}

//-----
-
public static String getString() throws IOException
{
    InputStreamReader isr = new InputStreamReader(System.in);
    BufferedReader br = new BufferedReader(isr);
    String s = br.readLine();
    return s;
}

//-----
public static char getChar() throws IOException
{
    String s = getString();
    return s.charAt(0);
}

//-----
public static int getInt() throws IOException
{
    String s = getString();
    return Integer.parseInt(s);
}

//-----
-
} // end class HashChainApp

```

Here's the output when the user creates a table with 20 lists, inserts 20 items into it, and displays it with the s option.

```
Enter size of hash table: 20
Enter initial number of items: 20
Enter first letter of show, insert, delete, or find: s
0. List (first-->last): 240 1160
1. List (first-->last):
2. List (first-->last):
3. List (first-->last): 143
4. List (first-->last): 1004
5. List (first-->last): 1485 1585
6. List (first-->last):
7. List (first-->last): 87 1407
8. List (first-->last):
9. List (first-->last): 309
10. List (first-->last): 490
11. List (first-->last):
12. List (first-->last): 872
13. List (first-->last): 1073
14. List (first-->last): 594 954
15. List (first-->last): 335
16. List (first-->last): 1216
17. List (first-->last): 1057 1357
18. List (first-->last): 938 1818
19. List (first-->last):
```

If you insert more items into this table, you'll see the lists grow longer, but maintain their sorted order. You can delete items as well.

We'll return to the question of when to use separate chaining when we discuss [hash table efficiency](#) later in this chapter.

Hash Functions

In this section we'll explore the issue of what makes a good hash function, and see if we can improve the approach to hashing strings mentioned at the beginning of this chapter.

Quick Computation

A good hash function is simple, so it can be computed quickly. The major advantage of hash tables is their speed. If the hash function is slow, this speed will be degraded. A hash function with many multiplications and divisions is not a good idea. (The bit-manipulation facilities of Java or C++, such as shifting bits right to divide a number by a multiple of 2, can sometimes be used to good advantage.)

The purpose of a hash function is to take a range of key values and transform them into index values in such a way that the key values are distributed randomly across all the indices of the hash table. Keys may be completely random or not so random.

Random Keys

A so-called *perfect* hash function maps every key into a different table location. This is only possible for keys that are unusually well behaved, and whose range is small enough to be used directly as array indices (as in the employee-number example at the beginning of this chapter).

In most cases neither of these situations exist, and the hash function will need to compress a larger range of keys into a smaller range of index numbers.

The distribution of key values in a particular database determines what the hash function needs to do. In this chapter we've assumed that the data was randomly distributed over its entire range. In this situation the hash function

```
index = key % arraySize;
```

is satisfactory. It involves only one mathematical operation, and if the keys are truly random the resulting indices will be random too, and therefore well distributed.

Non-Random Keys

However, data is often distributed non-randomly. Imagine a database that uses car-part numbers as keys. Perhaps these numbers are of the form

```
033-400-03-94-05-0-535
```

This is interpreted as follows:

- Digits 0–2: Supplier number (1 to 999, currently up to 70)
- Digits 3–5: Category code (100, 150, 200, 250, up to 850)
- Digits 6–7: Month of introduction (1 to 12)
- Digits 8–9: Year of introduction (00 to 99)
- Digits 10–11: Serial number (1 to 99, but never exceeds 100)
- Digit 12: Toxic risk flag (0 or 1)
- Digits 13–15: Checksum (sum of other fields, modulo 100)

The key used for the part number shown would be 0,334,000,394,050,535. However, such keys are not randomly distributed. The majority of numbers from 0 to 9,999,999,999,999 can't actually occur. (For example, supplier numbers above 70, category codes from that aren't multiples of 50, and months from 13 to 99.) Also, the checksum is not independent of the other numbers. Some work should be done to these part numbers to help ensure that they form a range of more truly random numbers.

Don't Use Non-Data

The key fields should be squeezed down until every bit counts. For example, the category codes should be changed to run from 0 to 15. Also, the checksum should be removed because it doesn't add any additional information; it's deliberately redundant. Various bit-twiddling techniques are appropriate for compressing the various fields in the key.

Use All the Data

Every part of the key (except non-data, as described above) should contribute to the hash function. Don't just use the first 4 digits or some such expurgation. The more data that contributes to the key, the more likely it is that the keys will hash evenly into the entire range of indices.

Sometimes the range of keys is so large it overflows type `int` or type `long` variables. We'll see how to handle overflow when we talk about hashing strings in a moment.

To summarize: The trick is to find a hash function that's simple and fast, yet excludes the non-data parts of the key and uses all the data.

Use a Prime Number for the Modulo Base

Often the hash function involves using the modulo operator (%) with the table size. We've already seen that it's important for the table size to be prime number when using a quadratic probe or double hashing. However, if the keys themselves may not be randomly distributed, it's important for the table size to be a prime number no matter what hashing system is used.

This is because, if many keys share a divisor with the array size, they may tend to hash to the same location, causing clustering. Using a prime table size eliminates this possibility. For example, if the table size is a multiple of 50 in our car part example, the category codes will all hash to index numbers that are multiples of 50. However, with a prime number such as 53, you are guaranteed that no keys will divide into the table size.

The moral is to examine your keys carefully, and tailor your hash algorithm to remove any irregularity in the distribution of the keys.

Hashing Strings

We saw at the beginning of this chapter how to convert short strings to key numbers by multiplying digit codes by powers of a constant. In particular, we saw that the four-letter word *cats* could turn into a number by calculating

$$\text{key} = 3*27^3 + 1*27^2 + 20*27^1 + 19*27^0$$

This approach has the desirable attribute of involving all the characters in the input string. The calculated key value can then be hashed into an array index in the usual way:

```
index = (key) % arraySize;
```

Here's a Java method that finds the key value of a word:

```
public static int hashFunc1(String key)
{
    int hashVal = 0;
    int pow27 = 1;                // 1, 27, 27*27, etc

    for(int j=key.length()-1; j>=0; j--) // right to left
    {
        int letter = key.charAt(j) - 96; // get char code
        hashVal += pow27 * letter;      // times power of 27
        pow27 *= 27;                   // next power of 27
    }
    return hashVal % arraySize;
} // end hashFunc1()
```

The loop starts at the rightmost letter in the word. If there are N letters, this is N-1. The numerical equivalent of the letter, according to the code we devised at the beginning of this chapter (`a=1` and so on), is placed in `letter`. This is then multiplied by a power of

27, which is 1 for the letter at N-1, 27 for the letter at N-2, and so on.

The `hashFunc1()` method is not as efficient as it might be. Aside from the character conversion, there are two multiplications and an addition inside the loop. We can eliminate a multiplication by taking advantage of a mathematical identity called Horner's method. (Horner was an English mathematician, 1773-1827.) This states that an expression like

$$\text{var4} * n^4 + \text{var3} * n^3 + \text{var2} * n^2 + \text{var1} * n^1 + \text{var0} * n^0$$

can be written as

$$(((\text{var4} * n + \text{var3}) * n + \text{var2}) * n + \text{var1}) * n + \text{var0}$$

To evaluate this, we can start inside the innermost parentheses and work outward. If we translate this to a Java method we have the following code:

```
public static int hashFunc2(String key)
{
    int hashVal = 0;
    for(int j=0; j<key.length(); j++)    // left to right
    {
        int letter = key.charAt(j) - 96; // get char code
        hashVal = hashVal * 27 + letter; // multiply and add
    }
    return hashVal % arraySize;        // mod
} // end hashFunc2()
```

Here we start with the leftmost letter of the word (which is somewhat more natural than starting on the right), and we have only one multiplication and one addition each time through the loop (aside from extracting the character from the string).

The `hashFunc2()` method unfortunately can't handle strings longer than about 7 letters. Longer strings cause the value of `hashVal` to exceed the size of type `int`. (If we used type `long`, the same problem would still arise for somewhat longer strings.)

Can we modify this basic approach so we don't overflow any variables? Notice that the key we eventually end up with is always less than the array size, because we apply the modulo operator. It's not the final index that's too big; it's the intermediate key values.

It turns out that with Horner's formulation we can apply the modulo (%) operator at each step in the calculation. This gives the same result as applying the modulo operator once at the end, but avoids overflow. (It does add an operation inside the loop.) The `hashFunc3()` method shows how this looks:

```
public static int hashFunc3(String key)
{
    int hashVal = 0;
    for(int j=0; j<key.length(); j++)    // left to right
    {
        int letter = key.charAt(j) - 96; // get char code
        hashVal = (hashVal * 27 + letter) % arraySize; // mod
    }
    return hashVal;                      // no mod
} // end hashFunc3()
```

This approach or something like it is normally taken to hash a string. Various bit-manipulation tricks can be played as well, such as using a base of 32 (or a larger power of 2) instead of 27, so that multiplication can be effected using the shift (>>) operator, which is faster than the modulo (%) operator.

You can use an approach similar to this to convert any kind of string to a number suitable for hashing. The strings can be words, names, or any other concatenation of characters.

Hashing Efficiency

We've noted that insertion and searching in hash tables can approach $O(1)$ time. If no collision occurs, only a call to the hash function and a single array reference are necessary to insert a new item or find an existing item. This is the minimum access time.

If collisions occur, access times become dependent on the resulting probe lengths. Each cell accessed during a probe adds another time increment to the search for a vacant cell (for insertion) or for an existing cell. During an access, a cell must be checked to see if it's empty, and—in the case of searching or deletion—if it contains the desired item.

Thus an individual search or insertion time is proportional to the length of the probe. This is in addition to a constant time for the hash function.

The average probe length (and therefore the average access time) is dependent on the load factor (the ratio of items in the table to the size of the table). As the load factor increases, probe lengths grow longer.

We'll look at the relationship between probe lengths and load factors for the various kinds of hash tables we've studied.

Open Addressing

The loss of efficiency with high load factors is more serious for the various open addressing schemes than for separate chaining.

In open addressing, unsuccessful searches generally take longer than successful searches. During a probe sequence, the algorithm can stop as soon as it finds the desired item, which is, on the average halfway through the probe sequence. On the other hand, it must go all the way to the end of the sequence before it's sure it can't find an item.

Linear Probing

The following equations show the relationship between probe length (P) and load factor (L) for linear probing. For a successful search it's

$$P = (1 + 1 / (1-L)^2) / 2$$

and for an unsuccessful search it's

$$P = (1 + 1 / (1-L)) / 2$$

These formulas are from Knuth (see [Appendix B, "Further Reading"](#)), and their derivation is quite complicated. Figure 11.12 shows the result of graphing these equations.

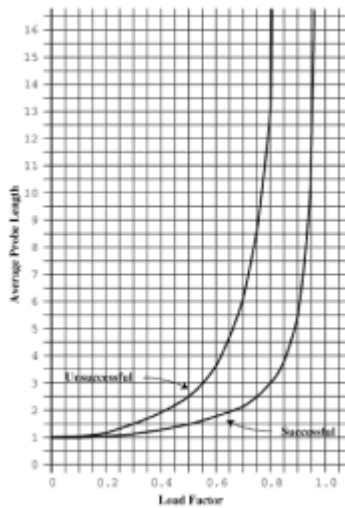

Figure 11.12: Linear probe performance

At a load factor of 1/2, a successful search takes 1.5 comparisons and an unsuccessful search takes 2.5. At a load factor of 2/3, the numbers are 2.0 and 5.0. At higher load factors the numbers become very large.

The moral, as you can see, is that the load factor must be kept under 2/3 and preferably under 1/2. On the other hand, the lower the load factor, the more memory is needed for a given amount of data. The optimum load factor in a particular situation depends on the tradeoff between memory efficiency, which decreases with lower load factors, and speed, which increases.

Quadratic Probing and Double Hashing

Quadratic probing and double hashing share their performance equations. These indicate a modest superiority over linear probing. For a successful search, the formula (again from Knuth) is

$$-\log^2(1-\text{loadFactor}) / \text{loadFactor}$$

For an unsuccessful search it is

$$1 / (1-\text{loadFactor})$$

Figure 11.13 shows graphs of these formulas. At a load factor of 0.5, successful and unsuccessful searches both require an average of two probes. At a 2/3 load factor, the numbers are 2.37 and 3.0, and at 0.8 they're 2.90 and 5.0. Thus somewhat higher load factors can be tolerated for quadratic probing and double hashing than for linear probing.

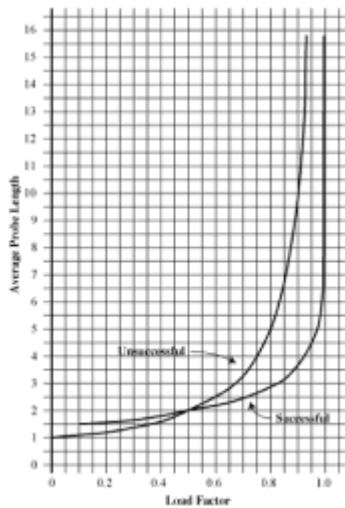

Figure 11.13: Quadratic-probe and double-hashing performance

Separate Chaining

The efficiency analysis for separate chaining is different, and generally easier, than for open addressing.

We want to know how long it takes to search for or insert an item into a separate-chaining hash table. We'll assume that the most time-consuming part of these operations is comparing the search key of the item with the keys of other items in the list. We'll also assume that the time required to hash to the appropriate list, and to determine when the end of a list has been reached, is equivalent to one key comparison. Thus all operations require $1 + n_{\text{Comps}}$ time, where n_{Comps} is the number of key comparisons.

Let's say that the hash table consists of `arraySize` elements, each of which holds a list, and that N data items have been inserted in the table. Then, on the average, each list will hold N divided by `arraySize` items:

$$\text{Average List Length} = N / \text{arraySize}$$

This is the same as the definition of the load factor:

$$\text{loadFactor} = N / \text{arraySize}$$

so the average list length equals the load factor.

Searching

In a successful search, the algorithm hashes to the appropriate list and then searches along the list for the item. On the average, half the items must be examined before the correct one is located. Thus the search time is

$$1 + \text{loadFactor} / 2$$

This is true whether the lists are ordered or not. In an unsuccessful search, if the lists are unordered, all the items must be searched, so the time is

$$1 + \text{loadFactor}$$

These formulas are graphed in Figure 11.14.

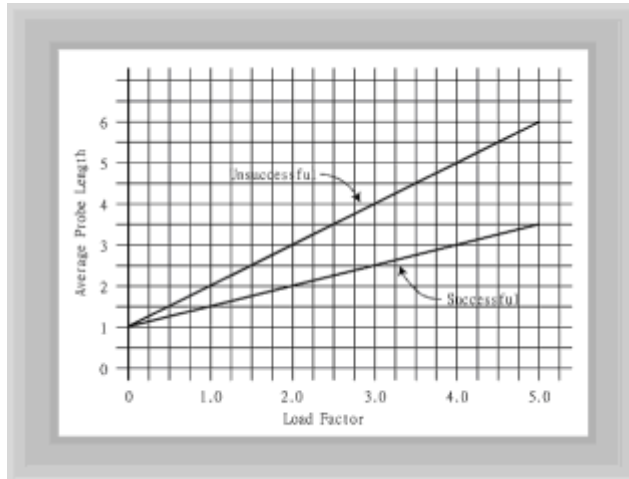

Figure 11.14: Separate-chaining performance

For an ordered list, only half the items must be examined in an unsuccessful search, so the time is the same as for a successful search.

In separate chaining it's typical to use a load factor of about 1.0 (the number of data items equals the array size). Smaller load factors don't improve performance significantly, but the time for all operations increases linearly with load factor, so going beyond 2 or so is generally a bad idea.

Insertion

If the lists are not ordered, insertion is always immediate, in the sense that no comparisons are necessary. The hash function must still be computed, so let's call the insertion time 1.

If the lists are ordered, then, as with an unsuccessful search, an average of half the items in each list must be examined, so the insertion time is $1 + \text{loadFactor} / 2$.

Open Addressing Versus Separate Chaining

If open addressing is to be used, double hashing seems to be the preferred system by a small margin over quadratic probing. The exception is the situation where plenty of memory is available and the data won't expand after the table is created; in this case linear probing is somewhat simpler to implement and, if load factors below 0.5 are used, causes little performance penalty.

If the number of items that will be inserted in a hash table isn't known when the table is created, separate chaining is preferable to open addressing. Increasing the load factor causes major performance penalties in open addressing, but performance degrades only linearly in separate chaining.

When in doubt, use separate chaining. Its drawback is the need for a linked list class, but the payoff is that adding more data than you anticipated won't cause performance to slow to a crawl.

Hashing and External Storage

At the end of the last chapter we discussed using B-trees as data structures for external

(disk-based) storage. Let's look briefly at the use of hash tables for external storage.

Recall from the last chapter that a disk file is divided into blocks containing many records, and that the time to access a block is much larger than any internal processing on data in main memory. For these reasons the overriding consideration in devising an external storage strategy is minimizing the number of block accesses.

On the other hand, external storage is not expensive per byte, so it may be acceptable to use large amounts of it, more than is strictly required to hold the data, if by so doing we can speed up access time. This is possible using hash tables.

Table of File Pointers

The central feature in external hashing is a hash table containing block numbers, which refer to blocks in external storage. The hash table is sometimes called an *index* (in the sense of a book's index). It can be stored in main memory, or, if it is too large, stored externally on disk, with only part of it being read into main memory at a time. Even if it fits entirely in main memory, a copy will probably be maintained on the disk, and read into memory when the file is opened.

Non-Full Blocks

Let's reuse the example from the last chapter in which the block size is 8,192 bytes, and a record is 512 bytes. Thus a block can hold 16 records. Every entry in the hash table points to one of these blocks. Let's say there are 100 blocks in a particular file.

The index (hash table) in main memory holds pointers to the file blocks, which start at 0 at the beginning of the file and run up to 99.

In external hashing it's important that blocks don't become full. Thus we might store an average of 8 records per block. Some blocks would have more records, and some fewer. There would be about 800 records in the file. This arrangement is shown in Figure 11.15.

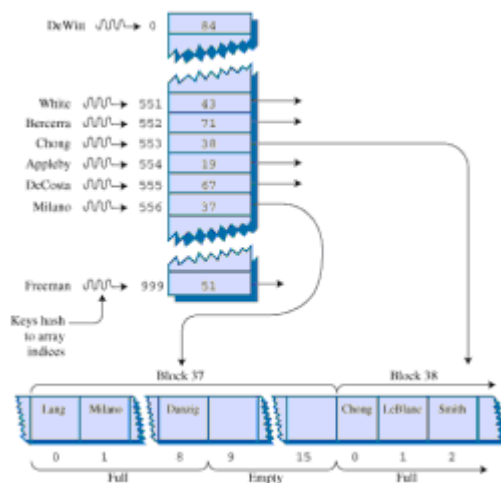

Figure 11.15: External hashing

All records with keys that hash to the same value are located in the same block. To find a record with a particular key, the search algorithm hashes the key, uses the hash value as an index to the hash table, gets the block number at that index, and reads the block.

This is an efficient process because only one block access is necessary to locate a given item. The downside is that considerable disk space is wasted because the blocks are, by

design, not full.

To implement this scheme the hash function and the size of the hash table must be chosen with some care, so that a limited number of keys hash to the same value. In our example we want only 8 records per key, on the average.

Full Blocks

Even with a good hash function, a block will occasionally become full. This can be handled using variations of the collision-resolution schemes discussed for internal hash tables: open addressing and separate chaining.

In open addressing, if during insertion one block is found to be full, the algorithm inserts the new record in a neighboring block. In linear probing this is the next block, but it could also be selected using a quadratic probe or double hashing. In separate chaining, special overflow blocks are made available; when a primary block is found to be full, the new record is inserted in the overflow block.

Full blocks are undesirable because an additional disk access is necessary for the second block; this doubles the access time. However, this is acceptable if it happens rarely.

We've discussed only the simplest hash table implementation for external storage. There are many more complex approaches that are beyond the scope of this book.

Summary

- A hash table is based on an array.
- The range of key values is usually greater than the size of the array.
- A key value is hashed to an array index by a hash function.
- An English-language dictionary is a typical example of a database that can be efficiently handled with a hash table.
- The hashing of a key to an already filled array cell is called a collision.
- Collisions can be handled in two major ways: open addressing and separate chaining.
- In open addressing, data items that hash to a full array cell are placed in another cell in the array.
- In separate chaining, each array element consists of a linked list. All data items hashing to a given array index are inserted in that list.
- We discussed three kinds of open addressing: linear probing, quadratic probing, and double hashing.
- In linear probing the step size is always 1, so if x is the array index calculated by the hash function, the probe goes to x , $x+1$, $x+2$, $x+3$, and so on.
- The number of such steps required to find a specified item is called the probe length.
- In linear probing, contiguous sequences of filled cells appear. These are called primary clusters, and they reduce performance.

- In quadratic probing the offset from x is the square of the step number, so the probe goes to x , $x+1$, $x+4$, $x+9$, $x+16$, and so on.
- Quadratic probing eliminates primary clustering, but suffers from the less severe secondary clustering.
- Secondary clustering occurs because all the keys that hash to the same value follow the same sequence of steps during a probe.
- All keys that hash to the same value follow the same probe sequence because the step size does not depend on the key, but only on the hash value.
- In double hashing the step size depends on the key, and is obtained from a secondary hash function.
- If the secondary hash function returns a value s in double hashing, the probe goes to x , $x+s$, $x+2s$, $x+3s$, $x+4s$, and so on, where s depends on the key, but remains constant during the probe.
- The load factor is the ratio of data items in a hash table to the array size.
- The maximum load factor in open addressing should be around 0.5. For double hashing at this load factor, searches will have an average probe length of 2.
- Search times go to infinity as load factors approach 1.0 in open addressing.
- It's crucial that an open-addressing hash table does not become too full.
- A load factor of 1.0 is appropriate for separate chaining.
- At this load factor a successful search has an average probe length of 1.5, and an unsuccessful search, 2.0.
- Probe lengths in separate chaining increase linearly with load factor.
- A string can be hashed by multiplying each character by a different power of a constant, adding the products, and using the modulo (%) operator to reduce the result to the size of the hash table.
- To avoid overflow, the modulo operator can be applied at each step in the process, if the polynomial is expressed using Horner's method.
- Hash table sizes should generally be prime numbers. This is especially important in quadratic probing and separate chaining.
- Hash tables can be used for external storage. One way to do this is to have the elements in the hash table contain disk-file block numbers.

Chapter 12: Heaps

Overview

We saw in [Chapter 4, "Stacks and Queues,"](#) that a priority queue is a data structure that offers convenient access to the data item with the smallest (or largest) key. This is useful when key values indicate the order in which items should be accessed.

Priority queues may be used for task scheduling in computers, where some programs and activities should be executed sooner than others and are therefore given a higher priority.

Another example is in weapons systems, say in a navy cruiser. A variety of threats—airplanes, missiles, submarines, and so on—are detected and must be prioritized. For example, a missile that's a short distance from the cruiser is assigned a higher priority than an aircraft a long distance away, so that countermeasures (surface-to-air missiles, for example) can deal with it first.

Priority queues are also used internally in other computer algorithms. In [Chapter 14, "Weighted Graphs,"](#) we'll see priority queues used in graph algorithms, such as Dijkstra's Algorithm.

A priority queue is an Abstract Data Type (ADT) offering methods that allow removal of the item with the maximum (or minimum) key value, insertion, and sometimes other activities. As with other ADTs, priority queues can be implemented using a variety of underlying structures. In [Chapter 4](#) we saw a priority queue implemented as an array. The trouble with that approach is that, even though removal of the largest item is accomplished in fast $O(1)$ time, insertion requires slow $O(N)$ time, because an average of half the items in the array must be moved to insert the new one in order.

In this chapter we'll describe another structure that can be used to implement a priority queue: the heap. A heap is a kind of tree. It offers both insertion and deletion in $O(\log N)$ time. Thus it's not quite as fast for deletion, but much faster for insertion. It's the method of choice for implementing priority queues where speed is important and there will be many insertions.

(Incidentally, don't confuse the term *heap*, used here for a special kind of binary tree, with the same term used to mean the portion of computer memory available to a programmer with `new` in languages like Java and C++.)

Chapter 12: Heaps

Overview

We saw in [Chapter 4, "Stacks and Queues,"](#) that a priority queue is a data structure that offers convenient access to the data item with the smallest (or largest) key. This is useful when key values indicate the order in which items should be accessed.

Priority queues may be used for task scheduling in computers, where some programs and activities should be executed sooner than others and are therefore given a higher priority.

Another example is in weapons systems, say in a navy cruiser. A variety of threats—airplanes, missiles, submarines, and so on—are detected and must be prioritized. For example, a missile that's a short distance from the cruiser is assigned a higher priority than an aircraft a long distance away, so that countermeasures (surface-to-air missiles, for example) can deal with it first.

Priority queues are also used internally in other computer algorithms. In [Chapter 14, "Weighted Graphs,"](#) we'll see priority queues used in graph algorithms, such as Dijkstra's Algorithm.

A priority queue is an Abstract Data Type (ADT) offering methods that allow removal of the item with the maximum (or minimum) key value, insertion, and sometimes other activities. As with other ADTs, priority queues can be implemented using a variety of underlying structures. In [Chapter 4](#) we saw a priority queue implemented as an array. The trouble with that approach is that, even though removal of the largest item is

accomplished in fast $O(1)$ time, insertion requires slow $O(N)$ time, because an average of half the items in the array must be moved to insert the new one in order.

In this chapter we'll describe another structure that can be used to implement a priority queue: the heap. A heap is a kind of tree. It offers both insertion and deletion in $O(\log N)$ time. Thus it's not quite as fast for deletion, but much faster for insertion. It's the method of choice for implementing priority queues where speed is important and there will be many insertions.

(Incidentally, don't confuse the term *heap*, used here for a special kind of binary tree, with the same term used to mean the portion of computer memory available to a programmer with `new` in languages like Java and C++.)

The Heap Workshop Applet

The Heap Workshop applet demonstrates the operations we discussed in the last section: It allows you to insert new items into a heap and remove the largest item. In addition you can change the priority of a given item.

When you start up the Heap Workshop applet, you'll see a display similar to Figure 12.7.

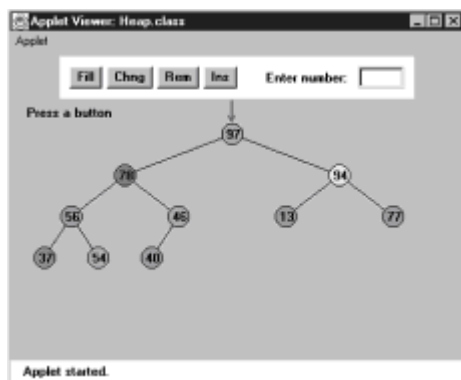

Figure 12.7: The Heap Workshop applet

There are four buttons: Fill, Chng, Rem, and Ins, for fill, change, remove, and insert. Let's see how they work.

Fill

The heap contains 10 nodes when the applet is first started. Using the Fill key you can create a new heap with any number of nodes from 1 to 31. Press Fill repeatedly, and type in the desired number when prompted.

Change

It's possible to change the priority of an existing node. This is a useful procedure in many situations. For example, in our cruiser example, a threat such as an approaching airplane may reverse course away from the carrier; its priority should be lowered to reflect this new development, although the aircraft would remain in the priority queue until it was out of radar range.

To change the priority of a node, repeatedly press the Chng key. When prompted, click on the node with the mouse. This will position the red arrow on the node. Then, when prompted, type in the node's new priority.

If the node's priority is raised, it will trickle upward to a new position. If the priority is lowered, the node will trickle downward.

Remove

Repeatedly pressing the Rem button causes the node with the highest key, located at the root, to be removed. You'll see it disappear, and then be replaced by the last (rightmost) node on the bottom row. Finally this node will trickle down until it reaches the position that reestablishes the heap order.

Insert

A new node is always inserted initially in the first available array cell, just to the right of the last node on the bottom row of the heap. From there it trickles up to the appropriate position. Pressing the Ins key repeatedly carries out this operation.

Java Code for Heaps

The complete code for `heap.java` is shown later in this section. Before we get to it, we'll focus on the individual operations of insertion, removal, and change.

Here are some things to remember from [Chapter 8](#) about representing a tree as an array. For a node at index x in the array,

- Its parent is $(x-1) / 2$
- Its left child is $2*x + 1$
- Its right child is $2*x + 2$

These relationships can be seen in [Figure 12.2](#). (Remember that the $/$ symbol, when applied to integers, performs integer division, in which the answer is rounded to the lowest integer.)

Insertion

We place the trickle-up algorithm in its own method. The `insert()` method, which includes a call to this `trickleUp()` method, is straightforward:

```
public boolean insert(int key)
{
    if(currentSize==maxSize)           // if array is full,
        return false;                 //    failure
    Node newNode = new Node(key);      // make a new node
    heapArray[currentSize] = newNode;  // put it at the end
    trickleUp(currentSize++);         // trickle it up
    return true;                       // success

} // end insert()
```

We check to make sure the array isn't full and then make a new node using the key value passed as an argument. This node is inserted at the end of the array. Finally the `trickleUp()` routine is called to move this node up to its proper position.

In `trickleUp()` (shown below) the argument is the index of the newly inserted item.

We find the parent of this position and then save the node in a variable called `bottom`. Inside the `while` loop, the variable `index` will trickle up the path toward the root, pointing to each node in turn. The `while` loop runs as long as we haven't reached the root (`index > 0`) and the key (`iData`) of `index`'s parent is less than the new node.

The body of the `while` loop executes one step of the trickle-up process. It first copies the parent node into `index`, moving the node down. (This has the effect of moving the "hole" upward.) Then it moves `index` upward by giving it its parent's index, and giving its parent *its* parent's index.

```
public void trickleUp(int index)
{
    int parent = (index-1) / 2;
    Node bottom = heapArray[index];

    while( index > 0 &&
           heapArray[parent].iData < bottom.iData )
    {
        heapArray[index] = heapArray[parent]; // move node down
        index = parent;                       // move index up
        parent = (parent-1) / 2;              // parent <- its parent
    } // end while
    heapArray[index] = bottom;

} // end trickleUp()
```

Finally, when the loop has exited, the newly inserted node, which has been temporarily stored in `bottom`, is inserted into the cell pointed to by `index`. This is the first location where it's not larger than its parent, so inserting it here satisfies the heap condition.

Removal

The removal algorithm is also not complicated if we subsume the trickle-down algorithm into its own routine. We save the node from the root, copy the last node (at `index currentSize-1`) into the root, and call `trickleDown()` to place this node in its appropriate location.

```
public Node remove() // delete item with max key
{ // (assumes non-empty list)
    Node root = heapArray[0]; // save the root
    heapArray[0] = heapArray[--currentSize]; // root <- last
    trickleDown(0); // trickle down the root
    return root; // return removed node
} // end remove()
```

This method returns the node that was removed; the user of the heap usually needs to process it in some way.

The `trickleDown()` routine is more complicated than `trickleUp()` because we must determine which of the two children is larger. First we save the node at `index` in a variable called `top`. If `trickleDown()` has been called from `remove()`, `index` is the root; but, as we'll see, it can be called from other routines as well.

The `while` loop will run as long as `index` is not on the bottom row—that is, as long as it

has at least one child. Within the loop we check if there is a right child (there may be only a left) and if so, compare the children's keys, setting `largerChild` appropriately.

Then we check if the key of the original node (now in `top`) is greater than that of `largerChild`; if so, the trickle-down process is complete and we exit the loop.

```
public void trickleDown(int index)
{
    int largerChild;
    Node top = heapArray[index];           // save root
    while(index < currentSize/2)          // while node has at
    {                                       // least one child,
        int leftChild = 2*index+1;
        int rightChild = leftChild+1;
                                           // find larger child
        if(rightChild < currentSize && // (rightChild exists?)
            heapArray[leftChild].iData <
            heapArray[rightChild].iData)
            largerChild = rightChild;
        else
            largerChild = leftChild;
                                           // top >= largerChild?
        if(top.iData >= heapArray[largerChild].iData)
            break;
                                           // shift child up
        heapArray[index] = heapArray[largerChild];
        index = largerChild;               // go down
    } // end while
    heapArray[index] = top;                 // index <- root
} // end trickleDown()
```

On exiting the loop we need only restore the node stored in `top` to its appropriate position, pointed to by `index`.

Key Change

Once we've created the `trickleDown()` and `trickleUp()` methods, it's easy to implement an algorithm to change the priority (the key) of a node and then trickle it up or down to its proper position. The `change()` method accomplishes this:

```
public boolean change(int index, int newValue)
{
    if(index<0 || index>=currentSize)
        return false;
    int oldValue = heapArray[index].iData; // remember old
    heapArray[index].iData = newValue;     // change to new

    if(oldValue < newValue)                 // if raised,
        trickleUp(index);                  // trickle it up
    else                                     // if lowered,
        trickleDown(index);                // trickle it down
    return true;
}
```

```
    } // end change()
```

This routine first checks that the index given in the first argument is valid, and if so, changes the `iData` field of the node at that index to the value specified as the second argument.

Then, if the priority has been raised, the node is trickled up; if it's been lowered, the node is trickled down.

Actually, the difficult part of changing a node's priority is not shown in this routine: finding the node you want to change. In the `change()` method just shown we supply the index as an argument, and in the Heap Workshop applet the user simply clicks on the selected node. In a real-world application a mechanism would be needed to find the appropriate node; as we've seen, the only node to which we normally have convenient access in a heap is the one with the largest key.

The problem can be solved in linear $O(N)$ time by searching the array sequentially. Or, a separate data structure (perhaps a hash table) could be updated with the new index value whenever a node was moved in the priority queue. This would allow quick access to any node. Of course, keeping a second structure updated would itself be time-consuming.

The Array Size

We should note that the array size, equivalent to the number of nodes in the heap, is a vital piece of information about the heap's state and a critical field in the `Heap` class. Nodes copied from the last position aren't erased, so the only way for algorithms to know the location of the last occupied cell is to refer to the current size of the array.

The heap.java Program

The `heap.java` program (see Listing 12.1) uses a `Node` class whose only field is the `iData` variable that serves as the node's key. As usual, this class would hold many other fields in a useful program. The `Heap` class contains the methods we discussed, plus `isEmpty()` and `displayHeap()`, which outputs a crude but comprehensible character-based representation of the heap.

Listing 12.1 The heap.java Program

```
// heap.java
// demonstrates heaps
// to run this program: C>java HeapApp
import java.io.*;           // for I/O
import java.lang.Integer;   // for parseInt()
////////////////////////////////////
class Node
{
    public int iData;        // data item (key)

    public Node(int key)    // constructor
    { iData = key; }
} // end class Node

////////////////////////////////////
```

```

class Heap
{
private Node[] heapArray;
private int maxSize;           // size of array
private int currentSize;       // number of nodes in array

// -----
-
public Heap(int mx)           // constructor
{
    maxSize = mx;
    currentSize = 0;
    heapArray = new Node[maxSize]; // create array
}

// -----
-
public boolean isEmpty()
    { return currentSize==0; }

// -----
-
public boolean insert(int key)
{
    if(currentSize==maxSize)
        return false;
    Node newNode = new Node(key);
    heapArray[currentSize] = newNode;
    trickleUp(currentSize++);
    return true;
} // end insert()

// -----
-
public void trickleUp(int index)
{
    int parent = (index-1) / 2;
    Node bottom = heapArray[index];

    while( index > 0 &&
           heapArray[parent].iData < bottom.iData )
    {
        heapArray[index] = heapArray[parent]; // move it down
        index = parent;
        parent = (parent-1) / 2;
    } // end while
    heapArray[index] = bottom;
} // end trickleUp()

// -----
-
public Node remove()           // delete item with max key
{                               // (assumes non-empty list)
    Node root = heapArray[0];

```

```

    heapArray[0] = heapArray[--currentSize];
    trickleDown(0);
    return root;
} // end remove()

// -----
-
public void trickleDown(int index)
{
    int largerChild;
    Node top = heapArray[index]; // save root
    while(index < currentSize/2) // while node has at
    { // least one child,
        int leftChild = 2*index+1;
        int rightChild = leftChild+1; // find larger child
        if(rightChild < currentSize && // (rightChild
exists?)
            heapArray[leftChild].iData <
            heapArray[rightChild].iData)
            largerChild = rightChild;
        else
            largerChild = leftChild; // top >= largerChild?
        if(top.iData >= heapArray[largerChild].iData)
            break; // shift child up
        heapArray[index] = heapArray[largerChild];
        index = largerChild; // go down
    } // end while
    heapArray[index] = top; // root to index
} // end trickleDown()

// -----
-
public boolean change(int index, int newValue)
{
    if(index<0 || index>=currentSize)
        return false;
    int oldValue = heapArray[index].iData; // remember old
    heapArray[index].iData = newValue; // change to new

    if(oldValue < newValue) // if raised,
        trickleUp(index); // trickle it up
    else // if lowered,
        trickleDown(index); // trickle it down
    return true;
} // end change()

// -----
-
public void displayHeap()
{
    System.out.print("heapArray: "); // array format

```



```

for(int m=0; m<currentSize; m++)
    if(heapArray[m] != null)
        System.out.print( heapArray[m].iData + " ");
    else
        System.out.print( "-- ");
System.out.println();

// heap format

int nBlanks = 32;
int itemsPerRow = 1;
int column = 0;
int j = 0; // current item
String dots = ".....";
System.out.println(dots+dots); // dotted top line

while(currentSize > 0) // for each heap item
{
    if(column == 0) // first item in row?
        for(int k=0; k<nBlanks; k++) // preceding blanks
            System.out.print(' '); // display item

    System.out.print(heapArray[j].iData);

    if(++j == currentSize) // done?
        break;

    if(++column==itemsPerRow) // end of row?
    {
        nBlanks /= 2; // half the blanks
        itemsPerRow *= 2; // twice the items
        column = 0; // start over on
        System.out.println(); // new row
    }
    else // next item on row
        for(int k=0; k<nBlanks*2-2; k++)
            System.out.print(' '); // interim blanks
    } // end for
System.out.println("\n"+dots+dots); // dotted bottom line
} // end displayHeap()

// -----
-
} // end class Heap

////////////////////////////////////

class HeapApp
{
    public static void main(String[] args) throws IOException
    {
        int value, value2;
        Heap theHeap = new Heap(31); // make a Heap; max size 31
        boolean success;

```

```

theHeap.insert(70);           // insert 10 items
theHeap.insert(40);
theHeap.insert(50);
theHeap.insert(20);
theHeap.insert(60);
theHeap.insert(100);
theHeap.insert(80);
theHeap.insert(30);
theHeap.insert(10);
theHeap.insert(90);

while(true)                  // until [Ctrl]-[C]
{
    putText("Enter first letter of ");
    putText("show, insert, remove, change: ");
    int choice = getChar();
    switch(choice)
    {
        case 's':              // show
            theHeap.displayHeap();
            break;
        case 'i':              // insert
            putText("Enter value to insert: ");
            value = getInt();
            success = theHeap.insert(value);
            if( !success )
                putText("Can't insert; heap is full" + '\n');
            break;
        case 'r':              // remove
            if( !theHeap.isEmpty() )
                theHeap.remove();
            else
                putText("Can't remove; heap is empty" +
'\n');
            break;
        case 'c':              // change
            putText("Enter index of item: ");
            value = getInt();
            putText("Enter new priority: ");
            value2 = getInt();
            success = theHeap.change(value, value2);
            if( !success )
                putText("Can't change; invalid index" +
'\n');
            break;
        default:
            putText("Invalid entry\n");
    } // end switch
} // end while
} // end main()

// -----
-

```

```

public static void putText(String s)
{
    System.out.print(s);
    System.out.flush();
}

//-----
public static String getString() throws IOException
{
    InputStreamReader isr = new InputStreamReader(System.in);
    BufferedReader br = new BufferedReader(isr);
    String s = br.readLine();
    return s;
}

//-----
public static char getChar() throws IOException
{
    String s = getString();
    return s.charAt(0);
}

//-----
public static int getInt() throws IOException
{
    String s = getString();
    return Integer.parseInt(s);
}

//-----
} // end class HeapApp

```

The array places the heap's root at index 0. Some heap implementations start the array with the root at 1, using position 0 as a sentinel value with the largest possible key. This saves an instruction in some of the algorithms, but complicates things conceptually.

The `main()` routine in `HeapApp` creates a heap with a maximum size of 31 (dictated by the limitations of the display routine) and inserts into it 10 nodes with random keys. Then it enters a loop in which the user can enter s, i, r, or c, for show, insert, remove, or change.

Here's some sample interaction with the program:

```

Enter first letter of show, insert, remove, change: s

heapArray: 100 90 80 30 60 50 70 20 10 40

.....

100

90                                80

```

```

          30          60          50          70
    20    10    40
    .....
Enter first letter of show, insert, remove, change: i
Enter value to insert: 53
Enter first letter of show, insert, remove, change: s
heapArray: 100 90 80 30 60 50 70 20 10 40 53
    .....
                100
          90          80
    30          60          50          70
    20    10    40    53
    .....
Enter first letter of show, insert, remove, change: r
Enter first letter of show, insert, remove, change: s
heapArray: 90 60 80 30 53 50 70 20 10 40
    .....
                90
          60          80
    30          53          50          70
    20    10    40
    .....
Enter first letter of show, insert, remove, change:

```

The user displays the heap, adds an item with a key of 53, shows the heap again, removes the item with the greatest key, and shows the heap a third time. The `show()` routine displays both the array and the tree versions of the heap. You'll need to use your imagination to fill in the connections between nodes.

Expanding the Heap Array

What happens if, while a program is running, too many items are inserted for the size of the heap array? A new array can be created, and the data from the old array copied into it. (Unlike the situation with hash tables, changing the size of a heap doesn't require reordering the data.) The copying operation takes linear time, but enlarging the array size shouldn't be necessary very often, especially if the array size is increased substantially each time it's expanded (by doubling it, for example).

In Java, a `Vector` class object could be used instead of an array; vectors can be expanded dynamically.

Efficiency of Heap Operations

For a heap with a substantial number of items, it's the trickle-up and trickle-down algorithms that are the most time-consuming parts of the operations we've seen. These algorithms spend time in a loop, repeatedly moving nodes up or down along a path. The number of copies necessary is bounded by the height of the heap; if there are five levels, four copies will carry the "hole" from the top to the bottom. (We'll ignore the two moves used to transfer the end node to and from temporary storage; they're always necessary so they require constant time.)

The `trickleUp()` method has only one major operation in its loop: comparing the key of the new node with the node at the current location. The `trickleDown()` method needs two comparisons, one to find the largest child, and a second to compare this child with the "last" node. They must both copy a node from top to bottom or bottom to top to complete the operation.

A heap is a special kind of binary tree, and as we saw in [Chapter 8](#), the number of levels L in a binary tree equals $\log_2(N+1)$, where N is the number of nodes. The `trickleUp()` and `trickleDown()` routines cycle through their loops $L-1$ times, so the first takes time proportional to $\log_2 N$, and the second somewhat more because of the extra comparison. Thus the heap operations we've talked about here all operate in $O(\log N)$ time.

Heapsort

The efficiency of the heap data structure lends itself to a surprisingly simple and very efficient sorting algorithm called *heapsort*.

The basic idea is to insert the unordered items into a heap using the normal `insert()` routine. Repeated application of the `remove()` routine will then remove the items in sorted order. Here's how that might look:

```
for(j=0; j<size; j++)
    theHeap.insert( anArray[j] );    // from unsorted array
for(j=0; j<size; j++)
    anArray[j] = theHeap.remove();  // to sorted array
```

Because `insert()` and `remove()` operate in $O(\log N)$ time, and each must be applied N times, the entire sort requires $O(N \cdot \log N)$ time, which is the same as quicksort. However, it's not quite as fast as quicksort. Partly this is because there are more operations in the inner `while` loop in `trickleDown()` than in the inner loop in quicksort.

However, several tricks can make heapsort more efficient. The first saves time, and the second saves memory.

Trickling Down in Place

If we insert N new items into a heap, we apply the `trickleUp()` method N times. However, if all the items are already in an array, they can be rearranged into a heap with only $N/2$ applications of `trickleDown()`. This offers a small speed advantage.

Two Correct Subheaps Make a Correct Heap

To see how this works, you should know that `trickleDown()` will create a correct heap if, when an out-of-order item is placed at the root, both the child subheaps of this root are correct heaps. (The root can itself be the root of a subheap as well as of the entire heap.) This is shown in Figure 12.8.

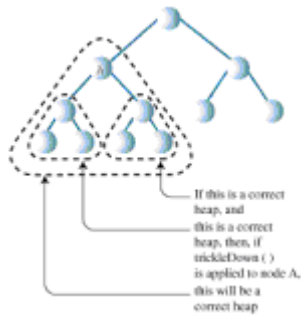

Figure 12.8: Both subtrees must be correct

This suggests a way to transform an unordered array into a heap. We can apply `trickleDown()` to the nodes on the bottom of the (potential) heap—that is, at the end of the array—and work our way upward to the root at index 0. At each step the subheaps below us will already be correct heaps because we already applied `trickleDown()` to them. After we apply `trickleDown()` to the root, the unordered array will have been transformed into a heap.

Notice however that the nodes on the bottom row—those with no children—are already correct heaps, because they are trees with only one node; they have no relationships to be out of order. Therefore we don't need to apply `trickleDown()` to these nodes. We can start at node $N/2-1$, the rightmost node with children, instead of $N-1$, the last node. Thus we need only half as many trickle operations as we would using `insert()` N times. [Figure 12.9](#) shows the order in which the trickle-down algorithm is applied, starting at node 6 in a 15-node heap.

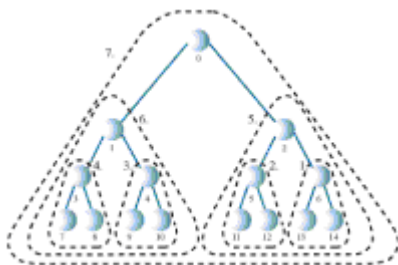

Figure 12.9: Order of applying `trickleDown()`

The following code fragment applies `trickleDown()` to all nodes, except those on the bottom row, starting at $N/2-1$ and working back to the root:

```
for(j=size/2-1; j >=0; j--)
```

```
theHeap.trickleDown(j);
```

A Recursive Approach

A recursive approach can also be used to form a heap from an array. A `heapify()` method is applied to the root. It calls itself for the root's two children, then for each of these children's two children, and so on. Eventually it works its way down to the bottom row, where it returns immediately whenever it finds a node with no children.

Once it has called itself for two child subtrees, `heapify()` then applies `trickleDown()` to the root of the subtree. This ensures that the subtree is a correct heap. Then `heapify()` returns and works on the subtree one level higher.

```
heapify(int index)      // transform array into heap
{
    if(index > N/2-1)   // if node has no children,
        return;        // return
    heapify(index*2+2); // turn right subtree into heap
    heapify(index*2+1); // turn left subtree into heap
    trickleDown(index); // apply trickle-down to this node
}
```

This recursive approach is probably not quite as efficient as the simple loop.

Using the Same Array

Our initial code fragment showed unordered data in an array. This data was then inserted into a heap, and finally removed from the heap and written back to the array in sorted order. In this procedure two size- N arrays are required: the initial array and the array used by the heap.

In fact, the same array can be used both for the heap and for the initial array. This cuts in half the amount of memory needed for heapsort; no memory beyond the initial array is necessary.

We've already seen how `trickleDown()` can be applied to half the elements of an array to transform them into a heap. We transform the unordered array data into a heap in place; only one array is necessary for this. Thus the first step in heapsort requires only one array.

However, things are more complicated when we apply `remove()` repeatedly to the heap. Where are we going to put the items that are removed?

Each time an item is removed from the heap, an element at the end of the heap array becomes empty; the heap shrinks by one. We can put the recently removed item in this newly freed cell. As more items are removed, the heap array becomes smaller and smaller, while the array of ordered data becomes larger and larger. Thus with a little planning it's possible for the ordered array and the heap array to share the same space. This is shown in Figure 12.10.

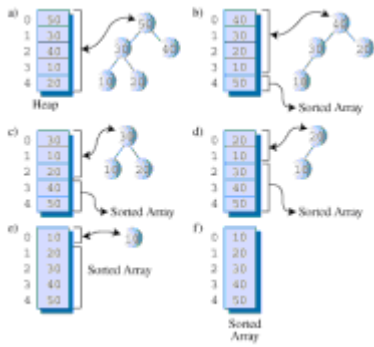

FIGURE 12.10: Dual-purpose array

The heapSort.java Program

We can put these two tricks—applying `trickleDown()` without using `insert()`, and using the same array for the initial data and the heap—together in a program that performs heapsort. Listing 12.2 shows how this looks.

Listing 12.2 The heapSort.java Program

```
// heapSort.java

// demonstrates heap sort

// to run this program: C>java HeapSortApp

import java.io.*;           // for I/O

import java.lang.Integer;  // for parseInt()

////////////////////////////////////

class Node
{
    public int iData;       // data item (key)

    public Node(int key)   // constructor
    { iData = key; }
} // end class Node

////////////////////////////////////

class Heap
{
    private Node[] heapArray;
    private int maxSize;   // size of array
    private int currentSize; // number of items in array

// -----
-
    public Heap(int mx)    // constructor
```



```

    {
    maxSize = mx;
    currentSize = 0;
    heapArray = new Node[maxSize];
    }

// -----
-
public Node remove()          // delete item with max key
    {                          // (assumes non-empty list)
    Node root = heapArray[0];
    heapArray[0] = heapArray[--currentSize];
    trickleDown(0);
    return root;
    } // end remove()

// -----
-
public void trickleDown(int index)
    {
    int largerChild;
    Node top = heapArray[index];          // save root
    while(index < currentSize/2)        // not on bottom row
        {
        int leftChild = 2*index+1;
        int rightChild = leftChild+1;

        // find larger child
        if(rightChild < currentSize && // right ch exists?
            heapArray[leftChild].iData <
            heapArray[rightChild].iData)
            largerChild = rightChild;
        else
            largerChild = leftChild;

        // top >=
largerChild?
        if(top.iData >= heapArray[largerChild].iData)
            break;

        // shift child up
        heapArray[index] = heapArray[largerChild];
        index = largerChild;          // go down
        } // end while
    heapArray[index] = top;          // root to index
    } // end trickleDown()

// -----
-
public void displayHeap()
    {
    int nBlanks = 32;
    int itemsPerRow = 1;
    int column = 0;
    int j = 0;                          // current item
    String dots = ".....";
    System.out.println(dots+dots);      // dotted top line

```

```

while(currentSize > 0) // for each heap item
{
    if(column == 0) // first item in row?
        for(int k=0; k<nBlanks; k++) // preceding blanks
            System.out.print(' ');

    // display item
    System.out.print(heapArray[j].iData);

    if(++j == currentSize) // done?
        break;

    if(++column==itemsPerRow) // end of row?
    {
        nBlanks /= 2; // half the blanks
        itemsPerRow *= 2; // twice the items
        column = 0; // start over on
        System.out.println(); // new row
    }
    else // next item on row
        for(int k=0; k<nBlanks*2-2; k++)
            System.out.print(' '); // interim blanks
    } // end for
System.out.println("\n"+dots+dots); // dotted bottom line
} // end displayHeap()

// -----
-
public void displayArray()
{
    for(int j=0; j<maxSize; j++)
        System.out.print(heapArray[j].iData + " ");
    System.out.println("");
}

// -----
-
public void insertAt(int index, Node newNode)
{ heapArray[index] = newNode; }

// -----
-
public void incrementSize()
{ currentSize++; }

// -----
-
} // end class Heap

////////////////////////////////////

class HeapSortApp
{
    public static void main(String[] args) throws IOException

```

```

    {
    int size, j;

    System.out.print("Enter number of items: ");
    size = getInt();
    Heap theHeap = new Heap(size);

    for(j=0; j<size; j++)          // fill array with
    {                               // random nodes
        int random = (int) (java.lang.Math.random()*100);
        Node newNode = new Node(random);
        theHeap.insertAt(j, newNode);
        theHeap.incrementSize();
    }

    System.out.print("Random: ");
        theHeap.displayArray(); // display random array

    for(j=size/2-1; j>=0; j--) // make random array into
heap        theHeap.trickleDown(j);

    System.out.print("Heap:  ");
    theHeap.displayArray(); // display heap array
    theHeap.displayHeap(); // display heap

    for(j=size-1; j>=0; j--) // remove from heap and
    {                               // store at array end
        Node biggestNode = theHeap.remove();
        theHeap.insertAt(j, biggestNode);
    }
    System.out.print("Sorted: ");
    theHeap.displayArray(); // display sorted array
    } // end main()

// -----
-
public static String getString() throws IOException
    {
        InputStreamReader isr = new InputStreamReader(System.in);
        BufferedReader br = new BufferedReader(isr);
        String s = br.readLine();
        return s;
    }

//-----
public static int getInt() throws IOException
    {
        String s = getString();
        return Integer.parseInt(s);
    }

// -----

```

-

```
} // end class HeapSortApp
```

The `Heap` class is much the same as in the `heap.java` program, except that to save space we've removed the `trickleUp()` and `insert()` methods, which aren't necessary for heapsort. We've also added an `insertAt()` method that allows direct insertion into the heap's array.

Notice that this addition is not in the spirit of object-oriented programming. The `Heap` class interface is supposed to shield class users from the underlying implementation of the heap. The underlying array should be invisible, but `insertAt()` allows direct access to it. In this situation we accept the violation of OOP principles because the array is so closely tied to the heap architecture.

An `incrementSize()` method is another addition to the heap class. It might seem as though we could combine this with `insertAt()`, but when inserting into the array in its role as an ordered array we don't want to increase the heap size, so we keep these functions separate.

The `main()` routine in the `HeapSortApp` class

1. Gets the array size from the user.
2. Fills the array with random data.
3. Turns the array into a heap with $N/2$ applications of `trickleDown()`.
4. Removes the items from the heap and writes them back at the end of the array.

After each step the array contents are displayed. The user selects the array size. Here's some sample output from `heapSort.java`:

```
Enter number of items: 10
Random: 81 6 23 38 95 71 72 39 34 53
Heap:   95 81 72 39 53 71 23 38 34 6
.....
                95
           81           72
      39           53           71           23
    38   34   6
.....
Sorted: 6 23 34 38 39 53 71 72 81 95
```

The Efficiency of Heapsort

As we noted, heapsort runs in $O(N \cdot \log N)$ time. Although it may be slightly slower than quicksort, an advantage over quicksort is that it is less sensitive to the initial distribution of data. Certain arrangements of key values can reduce quicksort to slow $O(N^2)$ time, whereas heapsort runs in $O(N \cdot \log N)$ time no matter how the data is distributed.

Summary

- In an ascending priority queue the item with the largest key (or smallest in a

descending queue) is said to have the highest priority.

- A priority queue is an Abstract Data Type (ADT) that offers methods for insertion of data and removal of the largest (or smallest) item.
- A heap is an efficient implementation of an ADT priority queue.
- A heap offers removal of the largest item, and insertion, in $O(N \log N)$ time.
- The largest item is always in the root.
- Heaps do not support ordered traversal of the data, locating an item with a specific key, or deletion.
- A heap is usually implemented as an array representing a complete binary tree. The root is at index 0 and the last item at index $N-1$.
- Each node has a key less than its parents and greater than its children.
- An item to be inserted is always placed in the first vacant cell of the array, and then trickled up to its appropriate position.
- When an item is removed from the root, it's replaced by the last item in the array, which is then trickled down to its appropriate position.
- The trickle-up and trickle-down processes can be thought of as a sequence of swaps, but are more efficiently implemented as a sequence of copies.
- The priority of an arbitrary item can be changed. First its key is changed; then, if the key was increased, the item is trickled up, while if the key was decreased the item is trickled down.
- Heapsort is an efficient sorting procedure that requires $O(N \log N)$ time.
- Conceptually heapsort consists of making N insertions into a heap, followed by N removals.
- Heapsort can be made to run faster by applying the trickle-down algorithm directly to $N/2$ items in the unsorted array, rather than inserting N items.
- The same array can be used for the initial unordered data, for the heap array, and for the final sorted data. Thus heapsort requires no extra memory.

Part V

Chapter List

[Chapter 13:](#) [Graphs](#)

[Chapter 14:](#) [Weighted Graphs](#)

[Chapter 15:](#) [When to Use What](#)

Chapter 13: Graphs

Overview

Graphs are one of the most versatile structures used in computer programming. The sorts of problems that graphs can help solve are generally quite different from those we've dealt with thus far in this book. If you're dealing with general kinds of data storage problems, you probably won't need a graph, but for some problems—and they tend to be interesting ones—a graph is indispensable.

Our discussion of graphs is divided into two chapters. In this chapter we'll cover the algorithms associated with unweighted graphs, show some algorithms that these graphs can represent, and present two Workshop applets to model them. In the [next chapter](#) we'll look at the more complicated algorithms associated with weighted graphs.

Introduction to Graphs

Graphs are data structures rather like trees. In fact, in a mathematical sense, a tree is a kind of graph. In computer programming, however, graphs are used in different ways than trees.

The data structures examined previously in this book have an architecture dictated by the algorithms used on them. For example, a binary tree is shaped the way it is because that shape makes it easy to search for data and insert new data. The edges in a tree represent quick ways to get from node to node.

Graphs, on the other hand, often have a shape dictated by a physical problem. For example, nodes in a graph may represent cities, while edges may represent airline flight routes between the cities. Another more abstract example is a graph representing the individual tasks necessary to complete a project. In the graph, nodes may represent tasks, while directed edges (with an arrow at one end) indicate which task must be completed before another. In both cases, the shape of the graph arises from the specific real-world situation.

Before going further, we must mention that, when discussing graphs, nodes are called *vertices* (the singular is *vertex*). This is probably because the nomenclature for graphs is older than that for trees, having arisen in mathematics centuries ago. Trees are more closely associated with computer science.

Definitions

Figure 13.1-a shows a simplified map of the freeways in the vicinity of San Jose, California. Figure 13.1-b shows a graph that models these freeways.

graph is not connected, as in Figure 13.2-b.

A non-connected graph consists of several *connected components*. In Figure 13.2-b, A and B are one connected component, and C and D are another.

For simplicity, the algorithms we'll be discussing in this chapter are written to apply to connected graphs, or to one connected component of a non-connected graph. If appropriate, small modifications will usually enable them to work with non-connected graphs as well.

Directed and Weighted Graphs

The graphs in [Figures 13.1](#) and 13.2 are *non-directed* graphs. That means that the edges don't have a *direction*; you can go either way on them. Thus you can go from vertex A to vertex B, or from vertex B to vertex A, with equal ease. (This models freeways appropriately, because you can usually go either way on a freeway.)

However, graphs are often used to model situations in which you can go in only one direction along an edge; from A to B but not from B to A, as on a one-way street. Such a graph is said to be *directed*. The allowed direction is typically shown with an arrowhead at the end of the edge.

In some graphs, edges are given a *weight*, a number that can represent the physical distance between two vertices, or the time it takes to get from one vertex to another, or how much it costs to travel from vertex to vertex (on airline routes, for example). Such graphs are called *weighted* graphs. We'll explore them in the [next chapter](#).

We're going to begin this chapter by discussing simple undirected, unweighted graphs; later we'll explore directed unweighted graphs.

We have by no means covered all the definitions that apply to graphs; we'll introduce more as we go along.

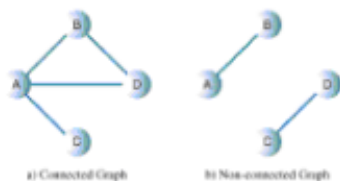

Figure 13.2: onnected and nonconnected graphs

Historical Note

One of the first mathematicians to work with graphs was Leonhard Euler in the early 18th century. He solved a famous problem dealing with the bridges in the town of Königsberg, Poland. This town included an island and seven bridges, as shown in Figure 13.3-a.

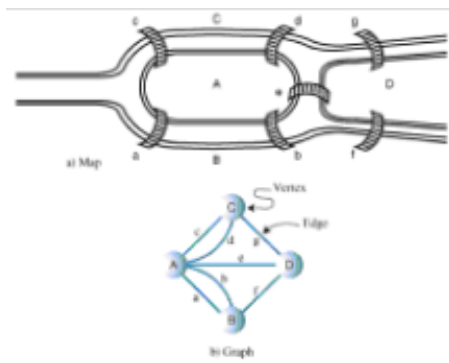

Figure 13.3: The bridges of Königsberg

The problem, much discussed by the townsfolk, was to find a way to walk across all seven bridges without recrossing any of them. We won't recount Euler's solution to the problem; it turns out that there is no such path. However, the key to his solution was to represent the problem as a graph, with land areas as vertices and bridges as edges, as shown in Figure 13.3-b. This is perhaps the first example of a graph being used to represent a problem in the real world.

Representing a Graph in a Program

It's all very well to think about graphs in the abstract, as Euler and other mathematicians did until the invention of the computer, but we want to represent graphs by using a computer. What sort of software structures are appropriate to model a graph? We'll look at vertices first, and then at edges.

Vertices

In a very abstract graph program you could simply number the vertices 0 to $N-1$ (where N is the number of vertices). You wouldn't need any sort of variable to hold the vertices, because their usefulness would result from their relationships with other vertices.

In most situations, however, a vertex represents some real-world object, and the object must be described using data items. If a vertex represents a city in an airline route simulation, for example, it may need to store the name of the city, its altitude, its location, and other such information. Thus it's usually convenient to represent a vertex by an object of a vertex class. Our example programs store only a letter (like A), used as a label for identifying the vertex, and a flag for use in search algorithms, as we'll see later. Here's how the `Vertex` class looks:

```
class Vertex
{
    public char label;          // label (e.g. 'A')
    public boolean wasVisited;

    public Vertex(char lab)    // constructor
    {
        label = lab;
        wasVisited = false;
    }

} // end class Vertex
```

`Vertex` objects can be placed in an array and referred to using their index number. In our

examples we'll store them in an array called `vertexList`. The vertices might also be placed in a list or some other data structure. Whatever structure is used, this storage is for convenience only. It has no relevance to how the vertices are connected by edges. For this, we need another mechanism.

Edges

In [Chapter 9, "Red-Black Trees,"](#) we saw that a computer program can represent trees in several ways. Mostly we examined trees in which each node contained references to its children, but we also mentioned that an array could be used, with a node's position in the array indicating its relationship to other nodes. [Chapter 12, "Heaps,"](#) described arrays used to represent a kind of tree called a *heap*.

A graph, however, doesn't usually have the same kind of fixed organization as a tree. In a binary tree, each node has a maximum of two children, but in a graph each vertex may be connected to an arbitrary number of other vertices. For example, in [Figure 13.2-a,](#) vertex A is connected to three other vertices, whereas C is connected to only one.

To model this sort of free-form organization, a different approach to representing edges is preferable to that used for trees. Two methods are commonly used for graphs: the *adjacency matrix* and the *adjacency list*. (Remember that one vertex is said to be *adjacent* to another if they're connected by a single edge.)

The Adjacency Matrix

An adjacency matrix is a two-dimensional array in which the elements indicate whether an edge is present between two vertices. If a graph has N vertices, the adjacency matrix is an NxN array. Table 13.1 shows the adjacency matrix for the graph in [Figure 13.2-a.](#)

Table 13.1: Adjacency Matrix

	A	B	C	D
A	0	1	1	1
B	1	0	0	1
C	1	0	0	0
D	1	1	0	0

The vertices are used as headings for both rows and columns. An edge between two vertices is indicated by a 1; the absence of an edge is a 0. (You could also use Boolean `true/false` values.) As you can see, vertex A is adjacent to all three other vertices, B is adjacent to A and D, C is adjacent only to A, and D is adjacent to A and B. In this example, the "connection" of a vertex to itself is indicated by 0, so the diagonal from upper-left to lower-right, A-A to D-D, which is called the *identity diagonal*, is all 0s. The entries on the identity diagonal don't convey any real information, so you can equally well put 1s along it, if that's more convenient in your program.

Note that the triangular-shaped part of the matrix above the identity diagonal is a mirror

image of the part below; both triangles contain the same information. This redundancy may seem inefficient, but there's no convenient way to create a triangular array in most computer languages, so it's simpler to accept the redundancy. Consequently, when you add an edge to the graph, you must make two entries in the adjacency matrix rather than one.

The Adjacency List

The other way to represent edges is with an adjacency list. The *list* in *adjacency list* refers to a linked list of the kind we examined in [Chapter 6, "Recursion."](#) Actually, an adjacency list is an array of lists (or a list of lists). Each individual list shows what vertices a given vertex is adjacent to. Table 13.2 shows the adjacency lists for the graph of [Figure 13.2-a](#).

Table 13.2: Adjacency Lists

Vertex	List Containing Adjacent Vertices
A	B → C → D
B	A → D
C	A
D	A → B

In this table, the → symbol indicates a link in a linked list. Each link in the list is a vertex. Here the vertices are arranged in alphabetical order in each list, although that's not really necessary. Don't confuse the contents of adjacency lists with paths. The adjacency list shows which vertices are adjacent to—that is, one edge away from—a given vertex, not paths from vertex to vertex.

Later we'll discuss when to use an adjacency matrix as opposed to an adjacency list. The workshop applets shown in this chapter all use the adjacency matrix approach, but sometimes the list approach is more efficient.

Adding Vertices and Edges to a Graph

To add a vertex to a graph, you make a new vertex object with `new` and insert it into your vertex array, `vertexList`. In a real-world program a vertex might contain many data items, but for simplicity we'll assume that it contains only a single character. Thus the creation of a vertex looks something like this:

```
vertexList[nVerts++] = new Vertex('F');
```

This inserts a vertex F, where `nVerts` is the number of vertices currently in the graph.

How you add an edge to a graph depends on whether you're using an adjacency matrix or adjacency lists to represent the graph. Let's say that you're using an adjacency matrix and want to add an edge between vertices 1 and 3. These numbers correspond to the

array indices in `vertexList` where the vertices are stored. When you first created the adjacency matrix `adjMat`, you filled it with 0s. To insert the edge, you say

```
adjMat[1][3] = 1;
adjMat[3][1] = 1;
```

If you were using an adjacency list, you would add a 1 to the list for 3, and a 3 to the list for 1.

The Graph Class

Let's look at a class `Graph` that contains methods for creating a vertex list and an adjacency matrix, and for adding vertices and edges to a `Graph` object:

```
class Graph
{
    private final int MAX_VERTS = 20;
    private Vertex vertexList[]; // array of vertices
    private int adjMat[][];      // adjacency matrix
    private int nVerts;         // current number of vertices

// -----
-
    public Graph()              // constructor
    {
        vertexList = new Vertex[MAX_VERTS];
                                // adjacency matrix
        adjMat = new int[MAX_VERTS][MAX_VERTS];
        nVerts = 0;
        for(int j=0; j<MAX_VERTS; j++) // set adjacency
            for(int k=0; k<MAX_VERTS; k++) // matrix to 0
                adjMat[j][k] = 0;
    } // end constructor

// -----
-
    public void addVertex(char lab) // argument is label
    {
        vertexList[nVerts++] = new Vertex(lab);
    }

// -----
-
    public void addEdge(int start, int end)
    {
        adjMat[start][end] = 1;
        adjMat[end][start] = 1;
    }

// -----
-
    public void displayVertex(int v)
    {
        System.out.print(vertexList[v].label);
    }
}
```

```

    }

// -----
-

} // end class Graph

```

Within the `Graph` class, vertices are identified by their index number in `vertexList`.

We've already discussed most of the methods shown here. To display a vertex, we simply print out its one-character label.

The adjacency matrix (or the adjacency list) provides information that is local to a given vertex. Specifically, it tells you which vertices are connected by a single edge to a given vertex. To answer more global questions about the arrangement of the vertices, we must resort to various algorithms. We'll begin with searches.

Searches

One of the most fundamental operations to perform on a graph is finding which vertices can be reached from a specified vertex. For example, imagine trying to find out how many towns in the United States can be reached by passenger train from Kansas City (assuming that you don't mind changing trains). Some towns could be reached. Others couldn't be reached because they didn't have passenger rail service. Possibly others couldn't be reached, even though they had rail service, because their rail system (the narrow-gauge Hayfork-Hicksville RR, for example) didn't connect with the standard-gauge line you started on or any of the lines that could be reached from your line.

Here's another situation in which you might need to find all the vertices reachable from a specified vertex. Imagine that you're designing a printed circuit board, like the ones inside your computer. (Open it up and take a look!) Various components—mostly integrated circuits (ICs)—are placed on the board, with pins from the ICs protruding through holes in the board. The ICs are soldered in place, and their pins are electrically connected to other pins by *traces*—thin metal lines applied to the surface of the circuit board, as shown in Figure 13.4. (No, you don't need to worry about the details of this figure.)

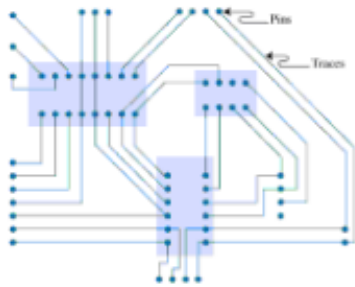

Figure 13.4: pins and traces on a circuit board

In a graph, each pin might be represented by a vertex, and each trace by an edge. On a circuit board there are many electrical circuits that aren't connected to each other, so the graph is by no means a connected one. During the design process, therefore, it may be genuinely useful to create a graph and use it to find which pins are connected to the same electrical circuit.

Assume that you've created such a graph. Now you need an algorithm that provides a systematic way to start at a specified vertex, and then move along edges to other vertices, in such a way that when it's done you are guaranteed that it has *visited* every

vertex that's connected to the starting vertex. Here, as it did in [Chapter 8, "Binary Trees,"](#) when we discussed binary trees, *visit* means to perform some operation on the vertex, such as displaying it.

There are two common approaches to searching a graph: *depth-first search (DFS)* and *breadth-first search (BFS)*. Both will eventually reach all connected vertices. The difference is that the depth-first search is implemented with a stack, whereas the breadth-first search is implemented with a queue. These mechanisms result, as we'll see, in the graph being searched in different ways.

Depth-First Search

The depth-first search uses a stack to remember where it should go when it reaches a dead end. We'll show an example, encourage you to try similar examples with the GraphN Workshop applet, and then finally show some code that carries out the search.

An Example

We'll discuss the idea behind the depth-first search in relation to Figure 13.5. The numbers in this figure show the order in which the vertices are visited.

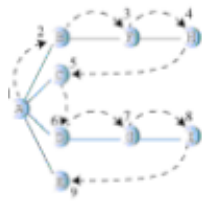

Figure 13.5: Depth-first search

To carry out the depth-first search, you pick a starting point—in this case, vertex A. You then do three things: visit this vertex, push it onto a stack so you can remember it, and mark it so you won't visit it again.

Next you go to any vertex adjacent to A that hasn't yet been visited. We'll assume the vertices are selected in alphabetical order, so that brings up B. You visit B, mark it, and push it on the stack.

Now what? You're at B, and you do the same thing as before: go to an adjacent vertex that hasn't been visited. This leads you to F. We can call this process Rule 1.

REMEMBER

Rule 1: If possible, visit an adjacent unvisited vertex, mark it, and push it on the stack.

Applying Rule 1 again leads you to H. At this point, however, you need to do something else, because there are no unvisited vertices adjacent to H. Here's where Rule 2 comes in.

REMEMBER

Rule 2: If you can't follow Rule 1, then, if possible, pop a vertex off the stack.

Following this rule, you pop H off the stack, which brings you back to F. F has no unvisited adjacent vertices, so you pop it. Ditto B. Now only A is left on the stack.

A, however, does have unvisited adjacent vertices, so you visit the next one, C. But C is the end of the line again, so you pop it and you're back to A. You visit D, G, and I, and then pop them all when you reach the dead end at I. Now you're back to A. You visit E,

and again you're back to A.

This time, however, A has no unvisited neighbors, so we pop it off the stack. But now there's nothing left to pop, which brings up Rule 3.

REMEMBER

Rule 3: If you can't follow Rule 1 or Rule 2, you're finished.

Table 13.3 shows how the stack looks in the various stages of this process, as applied to [Figure 13.5](#).

Table 13.3: Stack Contents During Depth-First Search

Event	Stack
Visit A	A
Visit B	AB
Visit F	ABF
Visit H	ABFH
Pop H	ABF
Pop F	AB
Pop B	A
Visit C	AC
Pop C	A
Visit D	AD
Visit G	ADG
Visit I	ADGI
Pop I	ADG
Pop G	AD
Pop D	A
Visit E	AE
Pop E	A

Pop A

Done



The contents of the stack is the route you took from the starting vertex to get where you are. As you move away from the starting vertex, you push vertices as you go. As you move back toward the starting vertex, you pop them. The order in which you visit the vertices is ABFHCDGIE.

You might say that the depth-first search algorithm likes to get as far away from the starting point as quickly as possible, and returns only when it reaches a dead end. If you use the term *depth* to mean the distance from starting point, you can see where the name *depth-first search* comes from.

An Analogy

An analogy you might think about in relation to depth-first search is a maze. The maze—perhaps one of the people-size ones made of hedges, popular in England—consists of narrow passages (think of edges) and intersections where passages meet (vertices).

Suppose that someone is lost in the maze. She knows there's an exit and plans to traverse the maze systematically to find it. Fortunately, she has a ball of string and a marker pen. She starts at some intersection and goes down a randomly chosen passage, unreeling the string. At the next intersection, she goes down another randomly chosen passage, and so on, until finally she reaches a dead end.

At the dead end she retraces her path, reeling in the string, until she reaches the previous intersection. Here she marks the path she's been down so she won't take it again, and tries another path. When she's marked all the paths leading from that intersection, she returns to the previous intersection and repeats the process.

The string represents the stack: It "remembers" the path taken to reach a certain point.

The GraphN Workshop Applet and DFS

You can try out the depth-first search with the DFS button in the GraphN Workshop applet. (The N is for *not directed*, *not weighted*.)

Start the applet. At the beginning, there are no vertices or edges, just an empty rectangle. You create vertices by double-clicking the desired location. The first vertex is automatically labeled A, the second one is B, and so on. They're colored randomly.

To make an edge, drag from one vertex to another. Figure 13.6 shows the graph of [Figure 13.5](#) as it looks when created using the applet.

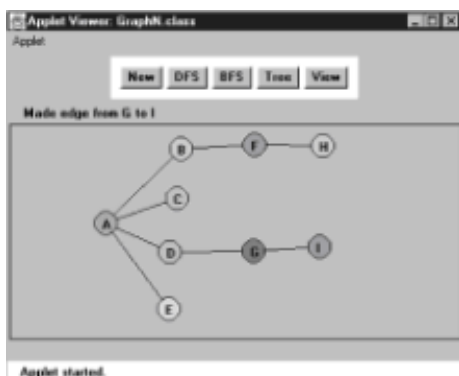
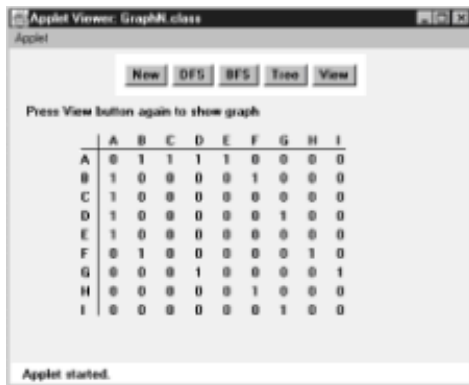

Figure 13.6: The GraphN Workshop applet

There's no way to delete individual edges or vertices, so if you make a mistake, you'll need to start over by clicking the New button, which erases all existing vertices and edges. (It warns you before it does this.) Clicking the View button switches you to the adjacency matrix for the graph you've made, as shown in Figure 13.7. Clicking View again switches you back to the graph.



	A	B	C	D	E	F	G	H	I
A	0	1	1	1	1	0	0	0	0
B	1	0	0	0	0	1	0	0	0
C	1	0	0	0	0	0	0	0	0
D	1	0	0	0	0	0	1	0	0
E	1	0	0	0	0	0	0	0	0
F	0	1	0	0	0	0	0	1	0
G	0	0	0	1	0	0	0	0	1
H	0	0	0	0	0	1	0	0	0
I	0	0	0	0	0	0	1	0	0

Figure 13.7: Adjacency matrix view in GraphNSearches

To run the depth-first search algorithm, click the DFS button repeatedly. You'll be prompted to click (*not* double-click) the starting vertex at the beginning of the process.

You can re-create the graph of Figure 13.6, or you can create simpler or more complex ones of your own. After you play with it a while, you can predict what the algorithm will do next (unless the graph is too weird).

If you use the algorithm on an unconnected graph, it will find only those vertices that are connected to the starting vertex.

Java Code

A key to the DFS algorithm is being able to find the vertices that are unvisited and adjacent to a specified vertex. How do you do this? The adjacency matrix is the key. By going to the row for the specified vertex and stepping across the columns, you can pick out the columns with a 1; the column number is the number of an adjacent vertex. You can then check whether this vertex is unvisited. If so, you've found what you want—the next vertex to visit. If no vertices on the row are simultaneously 1 (adjacent) and also unvisited, then there are no unvisited vertices adjacent to the specified vertex. We put the code for this process in the `getAdjUnvisitedVertex()` method:

```
// returns an unvisited vertex adjacent to v
public int getAdjUnvisitedVertex(int v)
{
    for(int j=0; j<nVerts; j++)
        if(adjMat[v][j]==1 && vertexList[j].wasVisited==false)
            return j;           // return first such vertex
    return -1;                 // no such vertices
} // end getAdjUnvisitedVert()
```

Now we're ready for the `dfs()` method of the `Graph` class, which actually carries out the depth-first search. You can see how this code embodies the three rules listed earlier. It loops until the stack is empty. Within the loop, it does four things:

1. It examines the vertex at the top of the stack, using `peek()`.
2. It tries to find an unvisited neighbor of this vertex.
3. If it doesn't find one, it pops the stack.
4. If it finds such a vertex, it visits it and pushes it onto the stack.

Here's the code for the `dfs()` method:

```
public void dfs() // depth-first search
{
    // begin at vertex 0
    vertexList[0].wasVisited = true; // mark it
    displayVertex(0); // display it
    theStack.push(0); // push it

    while( !theStack.isEmpty() ) // until stack empty,
    {
        // get an unvisited vertex adjacent to stack top
        int v = getAdjUnvisitedVertex( theStack.peek() );
        if(v == -1) // if no such vertex,
            theStack.pop(); // pop a new one
        else // if it exists,
            {
                vertexList[v].wasVisited = true; // mark it
                displayVertex(v); // display it
                theStack.push(v); // push it
            }
    } // end while

    // stack is empty, so we're done
    for(int j=0; j<nVerts; j++) // reset flags
        vertexList[j].wasVisited = false;

} // end dfs
```

At the end of `dfs()`, we reset all the `wasVisited` flags so we'll be ready to run `dfs()` again later. The stack should already be empty, so it doesn't need to be reset.

Now we have all the pieces of the `Graph` class we need. Here's some code that creates a graph object, adds some vertices and edges to it, and then performs a depth-first search:

```
Graph theGraph = new Graph();
theGraph.addVertex('A'); // 0 (start for dfs)
theGraph.addVertex('B'); // 1
theGraph.addVertex('C'); // 2
theGraph.addVertex('D'); // 3
theGraph.addVertex('E'); // 4
```

```

theGraph.addEdge(0, 1);    // AB
theGraph.addEdge(1, 2);    // BC
theGraph.addEdge(0, 3);    // AD
theGraph.addEdge(3, 4);    // DE

System.out.print("Visits: ");
theGraph.dfs();            // depth-first search
System.out.println();

```

Figure 13.8 shows the graph created by this code. Here's the output:

Visits: ABCDE

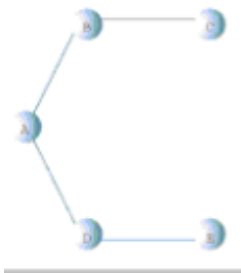

Figure 13.8: Graph used by `dfs.java` and `bfs.java` Searches

You can modify this code to create the graph of your choice, and then run it to see it carry out the depth-first search.

The `dfs.java` Program

Listing 13.1 shows the `dfs.java` program, which includes the `dfs()` method. It includes a version of the `StackX` class from [Chapter 4, "Stacks and Queues."](#)

Listing 13.1 The `dfs.java` Program

```

// dfs.java
// demonstrates depth-first search
// to run this program: C>java DFSApp
import java.awt.*;
////////////////////////////////////
class StackX
{
    private final int SIZE = 20;
    private int[] st;
    private int top;
    public StackX()            // constructor
    {
        st = new int[SIZE];    // make array
        top = -1;
    }
    public void push(int j)    // put item on stack
    { st[++top] = j; }
}

```

```

public int pop()          // take item off stack
    { return st[top--]; }
public int peek()        // peek at top of stack
    { return st[top]; }
public boolean isEmpty() // true if nothing on stack
    { return (top == -1); }
} // end class StackX

////////////////////////////////////////////////////////////////

class Vertex
{
    public char label;      // label (e.g. 'A')
    public boolean wasVisited;

// -----
public Vertex(char lab)    // constructor
    {
        label = lab;
        wasVisited = false;
    }

// -----
} // end class Vertex

////////////////////////////////////////////////////////////////

class Graph
{
    private final int MAX_VERTS = 20;
    private Vertex vertexList[]; // list of vertices
    private int adjMat[][];      // adjacency matrix
    private int nVerts;         // current number of vertices
    private StackX theStack;

// -----
public Graph()              // constructor
    {
        vertexList = new Vertex[MAX_VERTS];
                                // adjacency matrix
        adjMat = new int[MAX_VERTS][MAX_VERTS];
        nVerts = 0;
        for(int j=0; j<MAX_VERTS; j++) // set adjacency
            for(int k=0; k<MAX_VERTS; k++) // matrix to 0
                adjMat[j][k] = 0;
        theStack = new StackX();
    } // end constructor

// -----
public void addVertex(char lab)
    {
        vertexList[nVerts++] = new Vertex(lab);
    }
}

```

```

    }

// -----
public void addEdge(int start, int end)
{
    adjMat[start][end] = 1;
    adjMat[end][start] = 1;
}

// -----
public void displayVertex(int v)
{
    System.out.print(vertexList[v].label);
}

// -----
public void dfs() // depth-first search
{
    // begin at vertex 0
    vertexList[0].wasVisited = true; // mark it
    displayVertex(0); // display it
    theStack.push(0); // push it

    while( !theStack.isEmpty() ) // until stack empty,
    {
        // get an unvisited vertex adjacent to stack top
        int v = getAdjUnvisitedVertex( theStack.peek() );
        if(v == -1) // if no such vertex,
            theStack.pop();
        else // if it exists,
        {
            vertexList[v].wasVisited = true; // mark it
            displayVertex(v); // display it
            theStack.push(v); // push it
        }
    } // end while

    // stack is empty, so we're done
    for(int j=0; j<nVerts; j++) // reset flags
        vertexList[j].wasVisited = false;
} // end dfs

// -----
// returns an unvisited vertex adj to v
public int getAdjUnvisitedVertex(int v)
{
    for(int j=0; j<nVerts; j++)
        if(adjMat[v][j]==1 && vertexList[j].wasVisited==false)
            return j;
    return -1;
} // end getAdjUnvisitedVert()

// -----

```

```

    } // end class Graph

////////////////////////////////////

class DFSApp
{
    public static void main(String[] args)
    {
        Graph theGraph = new Graph();
        theGraph.addVertex('A'); // 0 (start for dfs)
        theGraph.addVertex('B'); // 1
        theGraph.addVertex('C'); // 2
        theGraph.addVertex('D'); // 3
        theGraph.addVertex('E'); // 4

        theGraph.addEdge(0, 1); // AB
        theGraph.addEdge(1, 2); // BC
        theGraph.addEdge(0, 3); // AD
        theGraph.addEdge(3, 4); // DE

        System.out.print("Visits: ");
        theGraph.dfs(); // depth-first search
        System.out.println();
    } // end main()
} // end class DFSApp

////////////////////////////////////

```

Breadth-First Search

As we saw in the depth-first search, the algorithm acts as though it wants to get as far away from the starting point as quickly as possible. In the breadth-first search, on the other hand, the algorithm likes to stay as close as possible to the starting point. It visits all the vertices adjacent to the starting vertex, and only then goes further afield. This kind of search is implemented using a queue instead of a stack.

An Example

Figure 13.9 shows the same graph as [Figure 13.5](#), but here the breadth-first search is used. Again, the numbers indicate the order in which the vertices are visited.

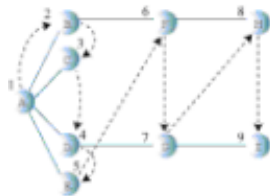

Figure 13.9: Breadth-first search

A is the starting vertex, so you visit it and make it the current vertex. Then you follow these rules:

REMEMBER

Rule 1: Visit the next unvisited vertex (if there is one) that's adjacent to the current vertex, mark it, and insert it into the queue.

REMEMBER

Rule 2: If you can't carry out Rule 1 because there are no more unvisited vertices, remove a vertex from the queue (if possible) and make it the current vertex.

REMEMBER

Rule 3: If you can't carry out Rule 2 because the queue is empty, you're finished.

Thus you first visit all the vertices adjacent to A, inserting each one into the queue as you visit it. Now you've visited A, B, C, D, and E. At this point the queue (from front to rear) contains BCDE.

There are no more unvisited vertices adjacent to A, so you remove B from the queue and look for vertices adjacent to B, so you remove C from the queue. It has no adjacent unvisited adjacent vertices, so you remove D and visit G. D has no more adjacent unvisited vertices, so you remove E. Now the queue is FG. You remove F and visit H, and then you remove G and visit I.

Now the queue is HI, but when you've removed each of these and found no adjacent unvisited vertices, the queue is empty, so you're finished. Table 13.4 shows this sequence.

Table 13.4: Queue Contents During Breadth-First Search

Event	Queue (Front to Rear)
Visit A	
Visit B	B
Visit C	BC
Visit D	BCD
Visit E	BCDE
Remove B	CDE
Visit F	CDEF
Remove C	DEF
Remove D	EF
Visit G	EFG

Remove E	FG
Remove F	G
Visit H	GH
Remove G	H
Visit I	HI
Remove H	I
Remove I	
Done	



At each moment, the queue contains the vertices that have been visited but whose neighbors have not yet been fully explored. (Contrast this with the depth-first search, where the contents of the stack is the route you took from the starting point to the current vertex.) The nodes are visited in the order ABCDEFGHI.

The GraphN Workshop Applet and BFS

Use the GraphN Workshop applet to try out a breadth-first search using the BFS button. Again, you can experiment with the graph of [Figure 13.9](#), or you can make up your own.

Notice the similarities and the differences of the breadth-first search compared with the depth-first search.

You can think of the breadth-first search as proceeding like ripples widening when you drop a stone in water—or, for those of you who enjoy epidemiology, as the influenza virus carried by air travelers from city to city. First, all the vertices one edge (plane flight) away from the starting point are visited, then all the vertices two edges away are visited, and so on.

Java Code

The `bfs()` method of the `Graph` class is similar to the `dfs()` method, except that it uses a queue instead of a stack and features nested loops instead of a single loop. The outer loop waits for the queue to be empty, whereas the inner one looks in turn at each unvisited neighbor of the current vertex. Here's the code:

```
public void bfs()                // breadth-first search
{
    vertexList[0].wasVisited = true; // mark it
    displayVertex(0);             // display it
    theQueue.insert(0);          // insert at tail
    int v2;

    while( !theQueue.isEmpty() ) // until queue empty,
    {
        int v1 = theQueue.remove(); // remove vertex at head
        // until it has no unvisited neighbors
    }
}
```



```

while( (v2=getAdjUnvisitedVertex(v1)) != -1 )
    {
        // get one,
        vertexList[v2].wasVisited = true; // mark it
        displayVertex(v2); // display it
        theQueue.insert(v2); // insert it
    } // end while(unvisited neighbors)
} // end while(queue not empty)

// queue is empty, so we're done
for(int j=0; j<nVerts; j++) // reset flags
    vertexList[j].wasVisited = false;

} // end bfs()

```

Given the same graph as in `dfs.java` (shown earlier in [Figure 13.8](#)), the output from `bfs.java` is now

```
Visits: ABDCE
```

The `bfs.java` Program

The `bfs.java` program, shown in Listing 13.2, is similar to `dfs.java` except for the inclusion of a `Queue` class (modified from the version in [Chapter 5, "Linked Lists"](#)) instead of a `StackX` class, and a `bfs()` method instead of a `dfs()` method.

Listing 13.2 The `bfs.java` Program

```

// bfs.java
// demonstrates breadth-first search
// to run this program: C>java BFSApp
import java.awt.*;
////////////////////////////////////
class Queue
{
    private final int SIZE = 20;
    private int[] queArray;
    private int front;
    private int rear;

    public Queue() // constructor
    {
        queArray = new int[SIZE];
        front = 0;
        rear = -1;
    }

    public void insert(int j) // put item at rear of queue
    {
        if(rear == SIZE-1)
            rear = -1;
        queArray[++rear] = j;
    }

    public int remove() // take item from front of queue
    {

```

```

        int temp = queArray[front++];
        if(front == SIZE)
            front = 0;
        return temp;
    }
    public boolean isEmpty() // true if queue is empty
    {
        return ( rear+1==front || (front+SIZE-1==rear) );
    }
} // end class Queue

////////////////////////////////////
class Vertex
{
    public char label; // label (e.g. 'A')
    public boolean wasVisited;

// -----
-
    public Vertex(char lab) // constructor
    {
        label = lab;
        wasVisited = false;
    }

// -----
-
} // end class Vertex

////////////////////////////////////

class Graph
{
    private final int MAX_VERTS = 20;
    private Vertex vertexList[]; // list of vertices
    private int adjMat[][]; // adjacency matrix
    private int nVerts; // current number of vertices
    private Queue theQueue;

// -----
    public Graph() // constructor
    {
        vertexList = new Vertex[MAX_VERTS];
// adjacency matrix
        adjMat = new int[MAX_VERTS][MAX_VERTS];
        nVerts = 0;
        for(int j=0; j<MAX_VERTS; j++) // set adjacency
            for(int k=0; k<MAX_VERTS; k++) // matrix to 0
                adjMat[j][k] = 0;
        theQueue = new Queue();
    } // end constructor

// -----

```

```

-
public void addVertex(char lab)
{
    vertexList[nVerts++] = new Vertex(lab);
}

// -----
-
public void addEdge(int start, int end)
{
    adjMat[start][end] = 1;
    adjMat[end][start] = 1;
}

// -----
-
public void displayVertex(int v)
{
    System.out.print(vertexList[v].label);
}

// -----
-
public void bfs() // breadth-first search
{ // begin at vertex 0
    vertexList[0].wasVisited = true; // mark it
    displayVertex(0); // display it
    theQueue.insert(0); // insert at tail
    int v2;

    while( !theQueue.isEmpty() ) // until queue empty,
    {
        int v1 = theQueue.remove(); // remove vertex at head
        // until it has no unvisited neighbors
        while( (v2=getAdjUnvisitedVertex(v1)) != -1 )
        { // get one,
            vertexList[v2].wasVisited = true; // mark it
            displayVertex(v2); // display it
            theQueue.insert(v2); // insert it
        } // end while
    } // end while(queue not empty)

    // queue is empty, so we're done
    for(int j=0; j<nVerts; j++) // reset flags
        vertexList[j].wasVisited = false;
} // end bfs()

// -----
-
// returns an unvisited vertex adj to v
public int getAdjUnvisitedVertex(int v)
{
    for(int j=0; j<nVerts; j++)
        if(adjMat[v][j]==1 && vertexList[j].wasVisited==false)

```

```

        return j;
    return -1;
} // end getAdjUnvisitedVert()

// -----
-
} // end class Graph

////////////////////////////////////
class BFSApp
{
    public static void main(String[] args)
    {
        Graph theGraph = new Graph();
        theGraph.addVertex('A'); // 0 (start for dfs)
        theGraph.addVertex('B'); // 1
        theGraph.addVertex('C'); // 2
        theGraph.addVertex('D'); // 3
        theGraph.addVertex('E'); // 4

        theGraph.addEdge(0, 1); // AB
        theGraph.addEdge(1, 2); // BC
        theGraph.addEdge(0, 3); // AD
        theGraph.addEdge(3, 4); // DE

        System.out.print("Visits: ");
        theGraph.bfs(); // breadth-first search
        System.out.println();
    } // end main()
} // end class BFSApp

////////////////////////////////////

```

Minimum Spanning Trees

Suppose that you've designed a printed circuit board like the one shown in [Figure 13.4](#), and you want to be sure you've used the minimum number of traces. That is, you don't want any extra connections between pins; such extra connections would take up extra room and make other circuits more difficult to lay out.

It would be nice to have an algorithm that, for any connected set of pins and traces (vertices and edges, in graph terminology), would remove any extra traces. The result would be a graph with the minimum number of edges necessary to connect the vertices. For example, Figure 13.10-a shows five vertices with an excessive number of edges, while Figure 13.10-b shows the same vertices with the minimum number of edges necessary to connect them. This constitutes a *minimum spanning tree*.

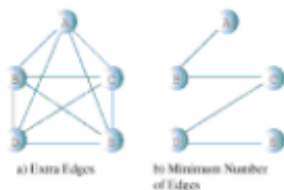

Figure 13.10: Minimum spanning tree

There are many possible minimum spanning trees for a given set of vertices. Figure 13.10-b shows edges AB, BC, CD, and DE, but edges AC, CE, ED, and DB would do just as well. The arithmetically inclined will note that the number of edges E in a minimum spanning tree is always one less than the number of vertices V:

$$E = V - 1$$

Remember that we're not worried here about the length of the edges. We're not trying to find a minimum physical length, just the minimum number of edges. (This will change when we talk about weighted graphs in the [next chapter](#).)

The algorithm for creating the minimum spanning tree is almost identical to that used for searching. It can be based on either the depth-first search or the breadth-first search. In our example we'll use the depth-first-search.

It turns out that by executing the depth-first search and recording the edges you've traveled to make the search, you automatically create a minimum spanning tree. The only difference between the minimum spanning tree method `mst()`, which we'll see in a moment, and the depth-first search method `dfs()`, which we saw earlier, is that `mst()` must somehow record the edges traveled.

GraphN Workshop Applet

Repeatedly clicking the Tree button in the GraphN Workshop algorithm will create a minimum spanning tree for any graph you create. Try it out with various graphs. You'll see that the algorithm follows the same steps as when using the DFS button to do a search. When using Tree, however, the appropriate edge is darkened when the algorithm assigns it to the minimum spanning tree. When it's finished, the applet removes all the non-darkened lines, leaving only the minimum spanning tree. A final button press restores the original graph, in case you want to use it again.

Java Code for the Minimum Spanning Tree

Here's the code for the `mst()` method:

```
while( !theStack.isEmpty() )           // until stack empty
{
    // get stack top
    int currentVertex = theStack.peek();
    // get next unvisited neighbor
    int v = getAdjUnvisitedVertex(currentVertex);
    if(v == -1)                          // if no more neighbors
        theStack.pop();                  // pop it away
    else                                  // got a neighbor
    {
        vertexList[v].wasVisited = true; // mark it
        theStack.push(v);                // push it
                                           // display edge
        displayVertex(currentVertex);    // from currentV
        displayVertex(v);                // to v
        System.out.print(" ");
    }
} // end while(stack not empty)

// stack is empty, so we're done
```

```

        for(int j=0; j<nVerts; j++)           // reset flags
            vertexList[j].wasVisited = false;

    } // end mst()

```

As you can see, this code is very similar to `dfs()`. In the `else` statement, however, the current vertex and its next unvisited neighbor are displayed. These two vertices define the edge that the algorithm is currently traveling to get to a new vertex, and it's these edges that make up the minimum spanning tree.

In the `main()` part of the `mst.java` program, we create a graph by using these statements:

```

Graph theGraph = new Graph();
theGraph.addVertex('A'); // 0 (start for mst)
theGraph.addVertex('B'); // 1
theGraph.addVertex('C'); // 2
theGraph.addVertex('D'); // 3
theGraph.addVertex('E'); // 4

theGraph.addEdge(0, 1); // AB
theGraph.addEdge(0, 2); // AC
theGraph.addEdge(0, 3); // AD
theGraph.addEdge(0, 4); // AE
theGraph.addEdge(1, 2); // BC
theGraph.addEdge(1, 3); // BD
theGraph.addEdge(1, 4); // BE
theGraph.addEdge(2, 3); // CD
theGraph.addEdge(2, 4); // CE
theGraph.addEdge(3, 4); // DE

```

The graph that results is the one shown in [Figure 13.10-a](#). When the `mst()` method has done its work, only four edges are left, as shown in [Figure 13.10-b](#). Here's the output from the `mst.java` program:

```

Minimum spanning tree: AB BC CD DE

```

As we noted, this is only one of many possible minimum spanning trees that can be created from this graph. Using a different starting vertex, for example, would result in a different tree. So would small variations in the code, such as starting at the end of the `vertexList[]` instead of the beginning in the `getAdjUnvisitedVertex()` method.

The `mst.java` Program

Listing 13.3 shows the `mst.java` program. It's similar to `dfs.java`, except for the `mst()` method and the graph created in `main()`.

Listing 13.3 The `mst.java` Program

```

// mst.java

// demonstrates minimum spanning tree

// to run this program: C>java MSTApp

```

```

import java.awt.*;

////////////////////////////////////

class StackX
{
    private final int SIZE = 20;
    private int[] st;
    private int top;
    public StackX()          // constructor
    {
        st = new int[SIZE]; // make array
        top = -1;
    }
    public void push(int j) // put item on stack
    { st[++top] = j; }
    public int pop()        // take item off stack
    { return st[top--]; }
    public int peek()       // peek at top of stack
    { return st[top]; }
    public boolean isEmpty() // true if nothing on stack
    { return (top == -1); }
}

////////////////////////////////////

class Vertex
{
    public char label;          // label (e.g. 'A')
    public boolean wasVisited;

// -----
-
    public Vertex(char lab)    // constructor
    {
        label = lab;
        wasVisited = false;
    }

// -----
-
} // end class Vertex

////////////////////////////////////

class Graph
{
    private final int MAX_VERTS = 20;
    private Vertex vertexList[]; // list of vertices
    private int adjMat[][];      // adjacency matrix
    // current number of vertices
    private StackX theStack;

```

```

// -----
-
public Graph()          // constructor
{
    vertexList = new Vertex[MAX_VERTS];
                                // adjacency matrix
    adjMat = new int[MAX_VERTS][MAX_VERTS];
    nVerts = 0;
    for(int j=0; j<MAX_VERTS; j++)    // set adjacency
        for(int k=0; k<MAX_VERTS; k++) // matrix to 0
            adjMat[j][k] = 0;
    theStack = new StackX();
} // end constructor

// -----
-
public void addVertex(char lab)
{
    vertexList[nVerts++] = new Vertex(lab);
}

// -----
-
public void addEdge(int start, int end)
{
    adjMat[start][end] = 1;
    adjMat[end][start] = 1;
}

// -----
-
public void displayVertex(int v)
{
    System.out.print(vertexList[v].label);
}

// -----
-
public void mst() // minimum spanning tree (depth first)
{
    // start at 0
    vertexList[0].wasVisited = true; // mark it
    theStack.push(0); // push it

    while( !theStack.isEmpty() ) // until stack empty
    {
        // get stack top
        int currentVertex = theStack.peek();
        // get next unvisited neighbor
        int v = getAdjUnvisitedVertex(currentVertex);
        if(v == -1) // if no more
neighbors
            theStack.pop(); // pop it away
        else // got a neighbor
            {

```



```

        vertexList[v].wasVisited = true; // mark it
        theStack.push(v);                // push it
                                        // display edge
        displayVertex(currentVertex);    // from currentV
        displayVertex(v);                // to v
        System.out.print(" ");
    }
} // end while(stack not empty)

// stack is empty, so we're done
for(int j=0; j<nVerts; j++)             // reset flags
    vertexList[j].wasVisited = false;
} // end tree

// -----
-
// returns an unvisited vertex adj to v
public int getAdjUnvisitedVertex(int v)
{
    for(int j=0; j<nVerts; j++)
        if(adjMat[v][j]==1 && vertexList[j].wasVisited==false)
            return j;
    return -1;
} // end getAdjUnvisitedVert()

// -----
-
} // end class Graph

////////////////////////////////////

class MSTApp
{
    public static void main(String[] args)
    {
        Graph theGraph = new Graph();
        theGraph.addVertex('A'); // 0 (start for mst)
        theGraph.addVertex('B'); // 1
        theGraph.addVertex('C'); // 2
        theGraph.addVertex('D'); // 3
        theGraph.addVertex('E'); // 4

        theGraph.addEdge(0, 1); // AB
        theGraph.addEdge(0, 2); // AC
        theGraph.addEdge(0, 3); // AD
        theGraph.addEdge(0, 4); // AE
        theGraph.addEdge(1, 2); // BC
        theGraph.addEdge(1, 3); // BD
        theGraph.addEdge(1, 4); // BE
        theGraph.addEdge(2, 3); // CD
        theGraph.addEdge(2, 4); // CE
        theGraph.addEdge(3, 4); // DE
    }
}

```

```

System.out.print("Minimum spanning tree: ");
theGraph.mst();           // minimum spanning tree
System.out.println();
} // end main()
} // end class MSTApp

```

////////////////////////////////////

Topological Sorting with Directed Graphs

Topological sorting is another operation that can be modeled with graphs. It's useful in situations in which items or events must be arranged in a specific order. Let's look at an example.

An Example: Course Prerequisites

In high school and college, students find (sometimes to their dismay) that they can't take just any course they want. Some courses have prerequisites—other courses that must be taken first. Indeed, taking certain courses may be a prerequisite to obtaining a degree in a certain field. Figure 13.11 shows a somewhat fanciful arrangement of courses necessary for graduating with a degree in mathematics.

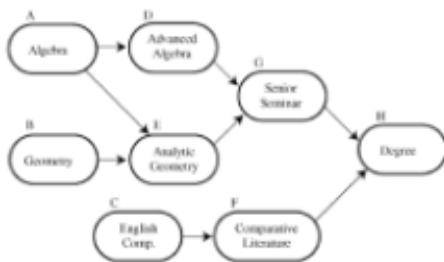

Figure 13.11: Course prerequisites

To obtain your degree, you must complete the Senior Seminar and (because of pressure from the English Department) Comparative Literature. But you can't take Senior Seminar without having already taken Advanced Algebra and Analytic Geometry, and you can't take Comparative Literature without taking English Composition. Also, you need Geometry for Analytic Geometry, and Algebra for both Advanced Algebra and Analytic Geometry.

Directed Graphs

As the figure shows, a graph can represent this sort of arrangement. However, the graph needs a feature we haven't seen before: The edges need to have a *direction*.



Figure 13.12: A small directed graph

When this is the case, the graph is called a *directed* graph. In a directed graph you can only proceed one way along an edge. The arrows in Figure 13.11 show the direction of

the edges.

In a program, the difference between a non-directed graph and a directed graph is that an edge in a directed graph has only one entry in the adjacency matrix. Figure 13.12 shows a small directed graph; Table 13.5 shows its adjacency matrix.

Table 13.5: Adjacency Matrix for Small Directed Graph

	A	B	C
A	0	1	0
B	0	0	1
C	0	0	0

Each edge is represented by a single 1. The row labels show where the edge starts, and the column labels show where it ends. Thus, the edge from A to B is represented by a single 1 at row A column B. If the directed edge were reversed so that it went from B to A, there would be a 1 at row B column A instead.

For a non-directed graph, as we noted earlier, half of the adjacency matrix mirrors the other half, so half the cells are redundant. However, for a weighted graph, every cell in the adjacency matrix conveys unique information.

For a directed graph, the method that adds an edge thus needs only a single statement,

```
public void addEdge(int start, int end) // directed graph
{
    adjMat[start][end] = 1;
}
```

instead of the two statements required in a non-directed graph.

If you use the adjacency-list approach to represent your graph, then A has B in its list but—unlike a non-directed graph—B does not have A in its list.

Topological Sorting

Imagine that you make a list of all the courses necessary for your degree, using [Figure 13.11](#) as your input data. You then arrange the courses in the order you need to take them. Obtaining your degree is the last item on the list, which might look like this:

BAEDGCFH

Arranged this way, the graph is said to be *topologically sorted*. Any course you must take before some other course occurs before it in the list.

Actually, many possible orderings would satisfy the course prerequisites. You could take the English courses C and F first, for example:

CFBAEDGH

This also satisfies all the prerequisites. There are many other possible orderings as well. When you use an algorithm to generate a topological sort, the approach you take and the details of the code determine which of various valid sortings are generated.

Topological sorting can model other situations besides course prerequisites. Job scheduling is an important example. If you're building a car, you want to arrange things so that brakes are installed before the wheels and the engine is assembled before it's bolted onto the chassis. Car manufacturers use graphs to model the thousands of operations in the manufacturing process, to ensure that everything is done in the proper order.

Modeling job schedules with graphs is called *critical path analysis*. Although we don't show it here, a weighted graph (discussed in the [next chapter](#)) can be used, which allows the graph to include the time necessary to complete different tasks in a project. The graph can then tell you such things as the minimum time necessary to complete the project.

The GraphD Workshop Applet

The GraphD Workshop applet models directed graphs. This applet operates in much the same way as GraphN but provides a dot near one end of each edge to show which direction the edge is pointing. Be careful: The direction you drag the mouse to create the edge determines the direction of the edge. Figure 13.13 shows the GraphD workshop applet used to model the course-prerequisite situation of [Figure 13.11](#).

The idea behind the topological sorting algorithm is unusual but simple. Two steps are necessary:

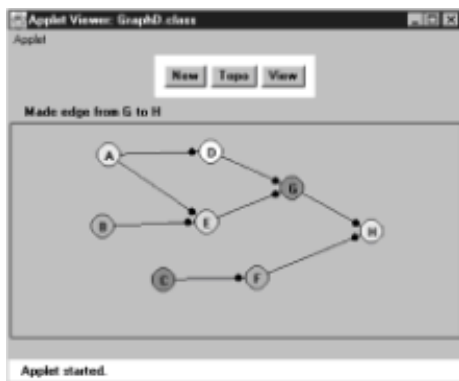

Figure 13.13: The GraphD Workshop applet

REMEMBER

Step 1: Find a vertex that has no successors.

The successors to a vertex are those vertices that are directly "downstream" from it—that is, connected to it by an edge that points in their direction. If there is an edge pointing from A to B, then B is a successor to A. In [Figure 13.11](#), the only vertex with no successors is H.

REMEMBER

Step 2: Delete this vertex from the graph, and insert its label at the beginning of a list.

Steps 1 and 2 are repeated until all the vertices are gone. At this point, the list shows the vertices arranged in topological order.

You can see the process at work by using the GraphD applet. Construct the graph of [Figure 13.11](#) (or any other graph, if you prefer) by double-clicking to make vertices and dragging to make edges. Then repeatedly click the Topo button. As each vertex is removed, its label is placed at the beginning of the list below the graph.

Deleting a vertex may seem like a drastic step, but it's the heart of the algorithm. The algorithm can't figure out the second vertex to remove until the first vertex is gone. If you need to, you can save the graph's data (the vertex list and the adjacency matrix) elsewhere and restore it when the sort is completed, as we do in the GraphD applet.

The algorithm works because if a vertex has no successors, it must be the last one in the topological ordering. As soon as it's removed, one of the remaining vertices must have no successors, so it will be the next-to-last one in the ordering, and so on.

The topological sorting algorithm works on unconnected graphs as well as connected graphs. This models the situation in which you have two unrelated goals, such as getting a degree in mathematics and at the same time obtaining a certificate in first aid.

Cycles and Trees

One kind of graph the topological-sort algorithm cannot handle is a graph with *cycles*. What's a cycle? It's a path that ends up where it started. In Figure 13.14 the path B-C-D-B forms a cycle. (Notice that A-B-C-A is not a cycle because you can't go from C to A.)



Figure 13.14: Graph with a cycle

A cycle models the Catch-22 situation (which some students claim to have actually encountered at certain institutions), where course B is a prerequisite for course C, C is a prerequisite for D, and D is a prerequisite for B.

A graph with no cycles is called a *tree*. The binary and multiway trees we saw earlier in this book are trees in this sense. However, the trees that arise in graphs are more general than binary and multiway trees, which have a fixed maximum number of child nodes. In a graph, a vertex in a tree can be connected to any number of other vertices, provided that no cycles are created.

A topological sort is carried out on a directed graph with no cycles. Such a graph is called a *directed, acyclic graph*, often abbreviated DAG.

Java Code

Here's the Java code for the `topo()` method, which carries out the topological sort:

```
public void topo()                // topological sort
{
```

```

int orig_nVerts = nVerts; // remember how many verts

while(nVerts > 0) // while vertices remain,
{
    // get a vertex with no successors, or -1
    int currentVertex = noSuccessors();
    if(currentVertex == -1) // must be a cycle
    {
        System.out.println("ERROR: Graph has cycles");
        return;
    }
    // insert vertex label in sorted array (start at end)
    sortedArray[nVerts-1] = vertexList[currentVertex].label;

    deleteVertex(currentVertex); // delete vertex
} // end while

// vertices all gone; display sortedArray
System.out.print("Topologically sorted order: ");
for(int j=0; j<orig_nVerts; j++)
    System.out.print( sortedArray[j] );
System.out.println("");

} // end topo

```

The work is done in the `while` loop, which continues until the number of vertices is reduced to 0. Here are the steps involved:

1. Call `noSuccessors()` to find any vertex with no successors.
2. If such a vertex is found, put the vertex label at the end of `sortedArray[]` and delete the vertex from the graph.

If an appropriate vertex isn't found, the graph must have a cycle.

The last vertex to be removed appears first on the list, so the vertex label is placed in `sortedArray` starting at the end and working toward the beginning, as `nVerts` (the number of vertices in the graph) gets smaller.

If vertices remain in the graph but all of them have successors, the graph must have a cycle, and the algorithm displays a message and quits. Normally, however, the `while` loop exits, and the list from `sortedArray` is displayed, with the vertices in topologically sorted order.

The `noSuccessors()` method uses the adjacency matrix to find a vertex with no successors. In the outer `for` loop, it goes down the rows, looking at each vertex. For each vertex, it scans across the columns in the inner `for` loop, looking for a 1. If it finds one, it knows that that vertex has a successor, because there's an edge from that vertex to another one. When it finds a 1, it bails out of the inner loop so that the next vertex can be investigated.

Only if an entire row is found with no 1s do we know we have a vertex with no successors; in this case, its row number is returned. If no such vertex is found, `-1` is returned. Here's the `noSuccessors()` method:

```

public int noSuccessors() // returns vert with no successors
{
    // (or -1 if no such verts)
    boolean isEdge; // edge from row to column in adjMat

    for(int row=0; row<nVerts; row++) // for each vertex,
    {
        isEdge = false; // check edges
        for(int col=0; col<nVerts; col++)
        {
            if( adjMat[row][col] > 0 ) // if edge to
            { // another,
                isEdge = true;
                break; // this vertex
            } // has a successor
        } // try another
        if( !isEdge ) // if no edges,
            return row; // has no successors
    }
    return -1; // no such vertex
} // end noSuccessors()

```

Deleting a vertex is straightforward except for a few details. The vertex is removed from the `vertexList[]` array, and the vertices above it are moved down to fill up the vacant position. Likewise, the row and column for the vertex are removed from the adjacency matrix, and the rows and columns above and to the right are moved down and to the left to fill the vacancies. This is carried out by the `deleteVertex()`, `moveRowUp()`, and `moveColLeft()` methods, which you can examine in the complete listing for `topo.java`. It's actually more efficient to use the adjacency-list representation of the graph for this algorithm, but that would take us too far afield.

The `main()` routine in this program calls on methods, similar to those we saw earlier, to create the same graph shown in [Figure 13.10](#). The `addEdge()` method, as we noted, inserts a single number into the adjacency matrix because this is a directed graph. Here's the code for `main()`:

```

public static void main(String[] args)
{
    Graph theGraph = new Graph();
    theGraph.addVertex('A'); // 0
    theGraph.addVertex('B'); // 1
    theGraph.addVertex('C'); // 2
    theGraph.addVertex('D'); // 3
    theGraph.addVertex('E'); // 4
    theGraph.addVertex('F'); // 5
    theGraph.addVertex('G'); // 6
    theGraph.addVertex('H'); // 7

    theGraph.addEdge(0, 3); // AD
    theGraph.addEdge(0, 4); // AE
    theGraph.addEdge(1, 4); // BE
    theGraph.addEdge(2, 5); // CF
    theGraph.addEdge(3, 6); // DG
    theGraph.addEdge(4, 6); // EG
}

```

```

theGraph.addEdge(5, 7);    // FH
theGraph.addEdge(6, 7);    // GH

theGraph.topo();          // do the sort

} // end main()

```

Once the graph is created, `main()` calls `topo()` to sort the graph and display the result. Here's the output:

```
Topologically sorted order: BAEDGCFH
```

Of course, you can rewrite `main()` to generate other graphs.

The Complete topo.java Program

You've seen most of the routines in `topo.java` already. Listing 13.4 shows the complete program.

Listing 13.4 The topo.java Program

```

// topo.java
// demonstrates topological sorting
// to run this program: C>java TopoApp
import java.awt.*;
////////////////////////////////////
class Vertex
{
    public char label;          // label (e.g. 'A')

    public Vertex(char lab)    // constructor
    { label = lab; }
} // end class Vertex

////////////////////////////////////

class Graph
{
    private final int MAX_VERTS = 20;
    private Vertex vertexList[]; // list of vertices
    private int adjMat[][];      // adjacency matrix
    private int nVerts;         // current number of vertices
    private char sortedArray[];

// -----
-
    public Graph()              // constructor
    {
        vertexList = new Vertex[MAX_VERTS];
                                                // adjacency matrix
        adjMat = new int[MAX_VERTS][MAX_VERTS];
        nVerts = 0;
        for(int j=0; j<MAX_VERTS; j++)        // set adjacency

```



```

        for(int k=0; k<MAX_VERTS; k++)    //    matrix to 0
            adjMat[j][k] = 0;
        sortedArray = new char[MAX_VERTS]; // sorted vert labels
    } // end constructor

// -----
-
    public void addVertex(char lab)
    {
        vertexList[nVerts++] = new Vertex(lab);
    }

// -----
-
    public void addEdge(int start, int end)
    {
        adjMat[start][end] = 1;
    }

// -----
-
    public void displayVertex(int v)
    {
        System.out.print(vertexList[v].label);
    }

// -----
-
    public void topo() // topological sort
    {
        int orig_nVerts = nVerts; // remember how many verts

        while(nVerts > 0) // while vertices remain,
        {
            // get a vertex with no successors, or -1
            int currentVertex = noSuccessors();
            if(currentVertex == -1) // must be a cycle
            {
                System.out.println("ERROR: Graph has cycles");
                return;
            }
            // insert vertex label in sorted array (start at end)
            sortedArray[nVerts-1] =
vertexList[currentVertex].label;

            deleteVertex(currentVertex); // delete vertex
        } // end while

        // vertices all gone; display sortedArray
        System.out.print("Topologically sorted order: ");
        for(int j=0; j<orig_nVerts; j++)
            System.out.print( sortedArray[j] );
        System.out.println("");
    } // end topo

```

```

-----
public int noSuccessors() // returns vert with no
successors
{
    // (or -1 if no such verts)
    boolean isEdge; // edge from row to column in adjMat

    for(int row=0; row<nVerts; row++) // for each vertex,
    {
        isEdge = false; // check edges
        for(int col=0; col<nVerts; col++)
        {
            if( adjMat[row][col] > 0 ) // if edge to
            { // another,
                isEdge = true;
                break; // this vertex
            } // has a successor
        } // try another
        if( !isEdge ) // if no edges,
            return row; // has no
successors
    }
    return -1; // no such vertex
} // end noSuccessors()

// -----
public void deleteVertex(int delVert)
{
    if(delVert != nVerts-1) // if not last vertex,
    { // delete from vertexList
        for(int j=delVert; j<nVerts-1; j++)
            vertexList[j] = vertexList[j+1];
        // delete row from adjMat
        for(int row=delVert; row<nVerts-1; row++)
            moveRowUp(row, nVerts);
        // delete col from adjMat
        for(int col=delVert; col<nVerts-1; col++)
            moveColLeft(col, nVerts-1);
    }
    nVerts--; // one less vertex
} // end deleteVertex

// -----
private void moveRowUp(int row, int length)
{
    for(int col=0; col<length; col++)
        adjMat[row][col] = adjMat[row+1][col];
}

// -----
private void moveColLeft(int col, int length)
{
    for(int row=0; row<length; row++)

```

```

        adjMat[row][col] = adjMat[row][col+1];
    }

// -----
-
} // end class Graph

////////////////////////////////////

class TopoApp
{
    public static void main(String[] args)
    {
        Graph theGraph = new Graph();
        theGraph.addVertex('A'); // 0
        theGraph.addVertex('B'); // 1
        theGraph.addVertex('C'); // 2
        theGraph.addVertex('D'); // 3
        theGraph.addVertex('E'); // 4
        theGraph.addVertex('F'); // 5
        theGraph.addVertex('G'); // 6
        theGraph.addVertex('H'); // 7

        theGraph.addEdge(0, 3); // AD
        theGraph.addEdge(0, 4); // AE
        theGraph.addEdge(1, 4); // BE
        theGraph.addEdge(2, 5); // CF
        theGraph.addEdge(3, 6); // DG
        theGraph.addEdge(4, 6); // EG
        theGraph.addEdge(5, 7); // FH
        theGraph.addEdge(6, 7); // GH

        theGraph.topo(); // do the sort
    } // end main()
} // end class TopoApp

////////////////////////////////////

```

In the [next chapter](#), we'll see what happens when edges are given a weight as well as a direction.

Summary

- Graphs consist of vertices connected by edges.
- Graphs can represent many real-world entities, including airline routes, electrical circuits, and job scheduling.
- Search algorithms allow you to visit each vertex in a graph in a systematic way. Searches are the basis of several other activities.
- The two main search algorithms are depth-first search (DFS) and breadth-first search (BFS).

- The depth-first search algorithm can be based on a stack; the breadth-first search algorithm can be based on a queue.
- A minimum spanning tree (MST) consists of the minimum number of edges necessary to connect all a graph's vertices.
- A slight modification of the depth-first search algorithm on an unweighted graph yields its minimum spanning tree.
- In a directed graph, edges have a direction (often indicated by an arrow).
- A topological sorting algorithm creates a list of vertices arranged so that a vertex A precedes a vertex B in the list if there's a path from A to B.
- A topological sort can be carried out only on a DAG, a directed, acyclic (no cycles) graph.
- Topological sorting is typically used for scheduling complex projects that consist of tasks contingent on other tasks.

Chapter 14: **Weighted Graphs**

Overview

In the [last chapter](#) we saw that a graph's edges can have direction. In this chapter we'll explore another edge feature: weight. For example, if vertices in a weighted graph represent cities, the weight of the edges might represent distances between the cities, or costs to fly between them, or the number of automobile trips made annually between them (a figure of interest to highway engineers).

When we include weight as a feature of a graph's edges, some interesting and complex questions arise. What is the minimum spanning tree for a weighted graph? What is the shortest (or cheapest) distance from one vertex to another? Such questions have important applications in the real world.

We'll first examine a weighted but non-directed graph and its minimum spanning tree. In the second half of this chapter we'll examine graphs that are both directed and weighted, in connection with the famous Dijkstra's Algorithm, used to find the shortest path from one vertex to another.

Minimum Spanning Tree with Weighted Graphs

To introduce weighted graphs we'll return to the question of the minimum spanning tree. Creating such a tree is a bit more complicated with a weighted graph than with an unweighted one. When all edges are the same length it's fairly straightforward—as we saw in the [last chapter](#)—for the algorithm to choose one to add to the minimum spanning tree. But when edges can have different weights, some arithmetic is needed to choose the right one.

An Example: Cable TV in the Jungle

Suppose we want to install a cable television line that connects six towns in the mythical country of Magnaguena. Five links will connect the six cities, but which five links should they be? The cost of connecting each pair of cities varies, so we must pick the route carefully to minimize the overall cost.

Figure 14.1 shows a weighted graph with 6 vertices, representing the towns Ajo, Bordo, Colina, Danza, Erizo, and Flor. Each edge has a weight, shown by a number alongside

the edge. Imagine that these numbers represent the cost, in millions of Magnaguenian dollars, of installing a cable link between two cities. (Notice that some links are impractical because of distance or terrain; for example, we will assume that it's too far from Ajo to Colina or from Danza to Flor, so these links don't need to be considered and don't appear on the graph.)

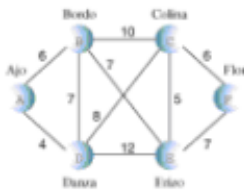

Figure 14.1: A weighted graph

How can we pick a route that minimizes the cost of installing the cable system? The answer is to calculate a minimum spanning tree. It will have five links (one fewer than the number of towns), it will connect all six towns, and it will minimize the total cost of building these links. Can you figure out this route by looking at the graph in Figure 14.1? If not, you can solve the problem with the GraphW Workshop applet.

The GraphW Workshop Applet

The GraphW Workshop applet is similar to GraphN and GraphD, but it creates weighted, undirected graphs. Before you drag from vertex to vertex to create an edge, you must type the weight of the edge into the text box in the upper-right corner.

This applet carries out only one algorithm: when you repeatedly click the Tree button, it finds the minimum spanning tree for whatever graph you have created. The New and View buttons work as in previous graph applets to erase an old graph and to view the adjacency matrix.

Try out this applet by creating some small graphs and finding their minimum spanning trees. (For some configurations you'll need to be careful positioning the vertices so that the weight numbers don't fall on top of each other.)

As you step through the algorithm you'll see that vertices acquire red borders, and edges are made thicker, when they're added to the minimum spanning tree. Vertices that are in the tree are also listed below the graph, on the left. On the right, the contents of a priority queue (PQ) is shown. The items in the priority queue are edges. For instance, the entry AB6 in the queue is the edge from A to B, which has a weight of 6. We'll explain what the priority queue does after we've shown an example of the algorithm.

Use the GraphW Workshop applet to construct the graph of [Figure 14.1](#). The result should resemble Figure 14.2.

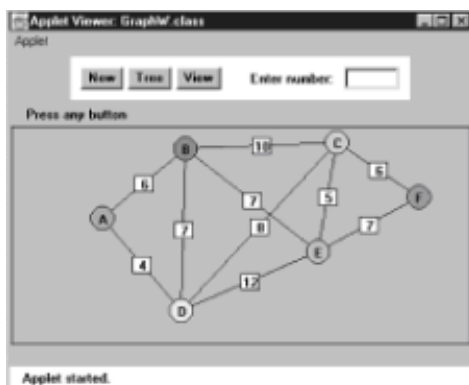

Figure 14.2: The GraphW Workshop applet

Now find this graph's minimum spanning tree by stepping through the algorithm with the Tree key. The result should be the minimum spanning tree shown in Figure 14.3.

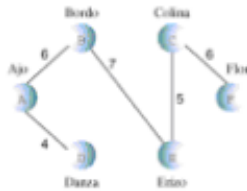

Figure 14.3: The minimum spanning tree

The applet should discover that the minimum spanning tree consists of the edges AD, AB, BE, EC, and CF, for a total edge weight of 28. The order in which the edges are specified is unimportant. If you start at a different vertex you will create a tree with the same edges, but in a different order.

Send Out the Surveyors

The algorithm for constructing the minimum spanning tree is a little involved, so we're going to introduce it using an analogy involving cable TV employees. You are one employee—a manager, of course—and there are also various surveyors.

A computer algorithm (unless perhaps it's a neural network) doesn't "know" about all the data in a given problem at once; it can't deal with the big picture. It must acquire the data little by little, modifying its view of things as it goes along. With graphs, algorithms tend to start at some vertex and work outward, acquiring data about nearby vertices before finding out about vertices farther away. We've seen examples of this in the depth-first and breadth-first searches in the [last chapter](#).

In a similar way, we're going to assume that you don't start out knowing the costs of installing the cable TV line between all the pairs of towns in Magnaguena. Acquiring this information takes time. That's where the surveyors come in.

Starting in Ajo

You start by setting up an office in Ajo. (You could start in any town, but Ajo has the best restaurants.) Only two towns are reachable from Ajo: Bordo and Danza (refer to [Figure 14.1](#)). You hire two tough, jungle-savvy surveyors and send them out along the dangerous wilderness trails, one to Bordo and one to Danza. Their job is to determine the cost of installing cable along these routes.

The first surveyor arrives in Bordo, having completed her survey, and calls you on her cellular phone; she says it will cost 6 million dollars to install the cable link between Ajo and Bordo. The second surveyor, who has had some trouble with crocodiles, reports a little later from Danza that the Ajo–Danza link, which crosses more level country, will cost only 4 million dollars. You make a list:

- Ajo–Danza, \$4 million
- Ajo–Bordo, \$6 million

You always list the links in order of increasing cost; we'll see why this is a good idea

soon.

Building the Ajo–Danza Link

At this point you figure you can send out the construction crew to actually install the cable from Ajo to Danza. How can you be sure the Ajo–Danza route will eventually be part of the cheapest solution (the minimum spanning tree)? So far, you only know the cost of two links in the system. Don't you need more information?

To get a feel for this situation, try to imagine some other route linking Ajo to Danza that would be cheaper than the direct link. If it doesn't go directly to Danza, this other route must go through Bordo and circle back to Danza, possibly via one or more other towns. But you already know the link to Bordo is more expensive, at 6 million dollars, than the link to Danza, at 4. So even if the remaining links in this hypothetical circle route are cheap, as shown in Figure 14.4, it will still be more expensive to get to Danza by going through Bordo. Also, it will be more expensive to get to towns on the circle route, like X, by going through Bordo than by going through Danza.

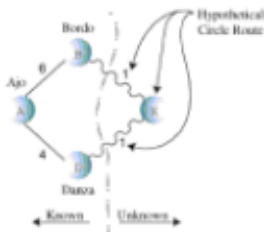

Figure 14.4: Hypothetical circle route

We conclude that the Ajo–Danza route will be part of the minimum spanning tree. This isn't a formal proof (which is beyond the scope of this book), but it does suggest your best bet is to pick the cheapest link. So you build the Ajo–Danza link and install an office in Danza.

Why do you need an office? Due to a Magnaguena government regulation, you must install an office in a town before you can send out surveyors from that town to adjacent towns. In graph terms, you must add a vertex to the tree before you can learn the weight of the edges leading away from that vertex. All towns with offices are connected by cable with each other; towns with no offices are not yet connected.

Building the Ajo–Bordo Link

Once you've completed the Ajo–Danza link and built your office in Danza, you can send out surveyors from Danza to all the towns reachable from there. These are Bordo, Colina, and Erizo. The surveyors reach their destinations and report back costs of 7, 8, and 12 million dollars, respectively. (Of course you don't send a surveyor to Ajo because you've already surveyed the Ajo–Danza route and installed its cable.)

Now you know the costs of four links from towns with offices to towns with no offices:

- Ajo–Bordo, \$6 million
- Danza–Bordo, \$7 million
- Danza–Colina, \$8 million
- Danza–Erizo, \$12 million

Why isn't the Ajo–Danza link still on the list? Because you've already installed the cable there; there's no point giving any further consideration to this link. The route on which a cable has just been installed is always removed from the list.

At this point it may not be obvious what to do next. There are many potential links to choose from. What do you imagine is the best strategy now? Here's the rule:

REMEMBER

Rule: From the list, always pick the cheapest edge.

Actually, you already followed this rule when you chose which route to follow from Ajo; the Ajo–Danza edge was the cheapest. Here the cheapest edge is Ajo–Bordo, so you install a cable link from Ajo to Bordo for a cost of 6 million dollars, and build an office in Bordo.

Let's pause for a moment and make a general observation. At a given time in the cable system construction, there are three kinds of towns:

1. Towns that have offices and are linked by cable. (In graph terms they're in the minimum spanning tree.)
2. Towns that aren't linked yet and have no office, but for which you know the cost to link them to at least one town with an office. We can call these "fringe" towns.
3. Towns you don't know anything about.

At this stage, Ajo, Danza, and Bordo are in category 1, Colina and Erizo are in category 2, and Flor is in category 3, as shown in Figure 14.5. As we work our way through the algorithm, towns move from category 3 to 2, and from 2 to 1.

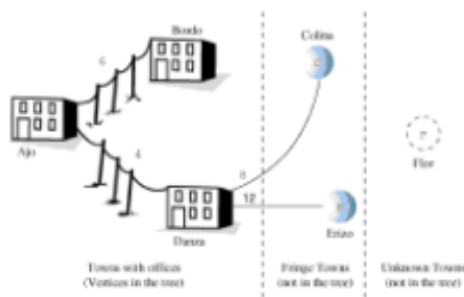

Figure 14.5: Partway through the minimum spanning tree algorithm

Building the Bordo–Erizo Link

At this point, Ajo, Danza, and Bordo are connected to the cable system and have offices. You already know the costs from Ajo and Danza to towns in category 2, but you don't know these costs from Bordo. So from Bordo you send out surveyors to Colina and Erizo. They report back costs of 10 to Colina and 7 to Erizo. Here's the new list:

- Bordo–Erizo, \$7 million
- Danza–Colina, \$8 million
- Bordo–Colina, \$10 million
- Danza–Erizo, \$12 million

The Danza–Bordo link was on the previous list but is not on this one because, as we noted, there's no point in considering links to towns that are already connected, even by an indirect route.

From this list we can see that the cheapest route is Bordo–Erizo, at 7 million dollars. You send out the crew to install this cable link, and you build an office in Erizo (refer to [Figure 14.3](#)).

Building the Erizo–Colina Link

From Erizo the surveyors report back costs of 5 to Colina and 7 to Flor. The Danza–Erizo link from the previous list must be removed because Erizo is now a connected town. Your new list is

- Erizo–Colina, \$5 million
- Erizo–Flor, \$7 million
- Danza–Colina, \$8 million
- Bordo–Colina, \$10 million

The cheapest of these links is Erizo–Colina, so you built this link and install an office in Colina.

And, Finally, the Colina–Flor Link

The choices are narrowing. After removing already linked towns, your list now shows only

- Colina–Flor, \$6 million
- Erizo–Flor, \$7 million

You install the last link of cable from Colina to Flor, build an office in Flor, and you're done. You know you're done because there's now an office in every town. You've constructed the cable route Ajo–Danza, Ajo–Bordo, Bordo–Erizo, Erizo–Colina, and Colina–Flor, as shown earlier in [Figure 14.3](#). This is the cheapest possible route linking the six towns of Magnaguena.

Creating the Algorithm

Using the somewhat fanciful idea of installing a cable TV system, we've shown the main ideas behind the minimum spanning tree for weighted graphs. Now let's see how we'd go about creating the algorithm for this process.

The Priority Queue

The key activity in carrying out the algorithm, as described in the cable TV example, was maintaining a list of the costs of links between pairs of cities. We decided where to build the next link by selecting the minimum of these costs.

A list in which we repeatedly select the minimum value suggests a priority queue as an appropriate data structure, and in fact this turns out to be an efficient way to handle the minimum spanning tree problem. Instead of a list or array, we use a priority queue. In a serious program this priority queue might be based on a heap, as described in [Chapter 12, "Heaps."](#) This would speed up operations on large priority queues. However, in our

demonstration program we'll use a priority queue based on a simple array.

Outline of the Algorithm

Let's restate the algorithm in graph terms (as opposed to cable TV terms):

Start with a vertex, put it in the tree. Then repeatedly do the following:

1. Find all the edges from the newest vertex to other vertices that aren't in the tree. Put these edges in the priority queue.
2. Pick the edge with the lowest weight, and add this edge and its destination vertex to the tree.

Do these steps until all the vertices are in the tree. At that point, you're done.

In step 1, "newest" means most recently installed in the tree. The edges for this step can be found in the adjacency matrix. After step 1, the list will contain all the edges from vertices in the tree to vertices on the fringe.

Extraneous Edges

In maintaining the list of links, we went to some trouble to remove links that led to a town that had recently become connected. If we didn't do this, we would have ended up installing unnecessary cable links.

In a programming algorithm we must likewise make sure that we don't have any edges in the priority queue that lead to vertices that are already in the tree. We could go through the queue looking for and removing any such edges each time we added a new vertex to the tree. As it turns out, it is easier to keep only one edge from the tree to a given fringe vertex in the priority queue at any given time. That is, the queue should contain only one edge to each category 2 vertex.

You'll see that this is what happens in the GraphW Workshop applet. There are fewer edges in the priority queue than you might expect; just one entry for each category 2 vertex. Step through the minimum spanning tree for [Figure 14.1](#) and verify that this is what happens. Table 14.1 shows how edges with duplicate destinations have been removed from the priority queue.

Table 14.1: Edge pruning

Step Number	Unpruned Edge List	Pruned Edge List (in PriorityQueue)	Duplicate Removed from Priority Queue
1	AB6, AD4	AB6, AD4	
2	DE12, DC8, DB7, AB6	DE12, DC8, AB6	DB7(AB6)
3	DE12, BC10, DC8, BE7	DC8, BE7	DE12(BE7), BC10(DC8)

4	BC10, DC8, EF7, EC5	EF7, EC5	BC10(EC5), DC8(EC5)
5	EF7, CF6	CF6	EF7

Remember that an edge consists of a letter for the source (starting) vertex of the edge, a letter for the destination (ending vertex), and a number for the weight. The second column in this table corresponds to the lists you kept when constructing the cable TV system. It shows all edges from category 1 vertices (those in the tree) to category 2 vertices (those with at least one known edge from a category 1 vertex).

The third column is what you see in the priority queue when you run the GraphW applet. Any edge with the same destination vertex as another edge, and which has a greater weight, has been removed.

The fourth column shows the edges that have been removed, and, in parentheses, the edge with the smaller weight that superseded it and remains in the queue. Remember that as you go from step to step the last entry on the list is always removed because this edge is added to the tree.

Looking for Duplicates in the Priority Queue

How do we make sure there is only one edge per category 2 vertex? Each time we add an edge to the queue, we make sure there's no other edge going to the same destination. If there is, we keep only the one with the smallest weight.

This necessitates looking through the priority queue item by item, to see if there's such a duplicate edge. Priority queues are not designed for random access, so this is not an efficient activity. However, violating the spirit of the priority queue is necessary in this situation.

Java Code

The method that creates the minimum spanning tree for a weighted graph, `mstw()`, follows the algorithm outlined above. As in our other graph programs, it assumes there's a list of vertices in `vertexList[]`, and that it will start with the vertex at index 0. The `currentVert` variable represents the vertex most recently added to the tree. Here's the code for `mstw()`:

```
public void mstw()           // minimum spanning tree
{
    currentVert = 0;        // start at 0

    while(nTree < nVerts-1) // while not all verts in tree
    {
        // put currentVert in tree
        vertexList[currentVert].isInTree = true;
        nTree++;

        // insert edges adjacent to currentVert into PQ
        for(int j=0; j<nVerts; j++) // for each vertex,
        {
            if(j==currentVert) // skip if it's us
                continue;
            if(vertexList[j].isInTree) // skip if in the tree
```

```

        continue;
    int distance = adjMat[currentVert][j];
    if( distance == INFINITY) // skip if no edge
        continue;
    putInPQ(j, distance); // put it in PQ (maybe)
    }
if(thePQ.size()==0) // no vertices in PQ?
    {
    System.out.println(" GRAPH NOT CONNECTED");
    return;
    }
// remove edge with minimum distance, from PQ
Edge theEdge = thePQ.removeMin();
int sourceVert = theEdge.srcVert;
currentVert = theEdge.destVert;

// display edge from source to current
System.out.print( vertexList[sourceVert].label );
System.out.print( vertexList[currentVert].label );
System.out.print(" ");
} // end while(not all verts in tree)

// mst is complete
for(int j=0; j<nVerts; j++) // unmark vertices
    vertexList[j].isInTree = false;

} // end mstw()

```

The algorithm is carried out in the `while` loop, which terminates when all vertices are in the tree. Within this loop the following activities take place:

1. The current vertex is placed in the tree.
2. The edges adjacent to this vertex are placed in the priority queue (if appropriate).
3. The edge with the minimum weight is removed from priority queue. The destination vertex of this edge becomes the current vertex.

Let's look at these steps in more detail. In step 1, the `currentVert` is placed in the tree by marking its `isInTree` field.

In step 2, the edges adjacent to this vertex are considered for insertion in the priority queue. The edges are examined by scanning across the row whose number is `currentVert` in the adjacency matrix. An edge is placed in the queue unless one of these conditions is true:

- The source and destination vertices are the same.
- The destination vertex is in the tree.
- There is no edge to this destination.

If none of these conditions is true, the `putInPQ()` method is called to put the edge in the priority queue. Actually, this routine doesn't always put the edge in the queue either, as

we'll see in a moment.

In step 3, the edge with the minimum weight is removed from the priority queue. This edge and its destination vertex are added to the tree, and the source vertex (`currentVert`) and destination vertex are displayed.

At the end of `mstw()`, the vertices are removed from the tree by resetting their `isInTree` variables. That isn't strictly necessary in this program, because only one tree is created from the data. However, it's good housekeeping to restore the data to its original form when you finish with it.

As we noted, the priority queue should contain only one edge with a given destination vertex. The `putInPQ()` method makes sure this is true. It calls the `find()` method of the `PriorityQ` class, which has been doctored to find the edge with a specified destination vertex. If there is no such vertex, and `find()` therefore returns `-1`, then `putInPQ()` simply inserts the edge into the priority queue. However, if such an edge does exist, `putInPQ()` checks to see whether the existing edge or the new proposed edge has the lower weight. If it's the old edge, no change is necessary. If the new one has a lower weight, the old edge is removed from the queue and the new one is installed. Here's the code for `putInPQ()`:

```
public void putInPQ(int newVert, int newDist)
{
    // is there another edge with the same destination vertex?
    int queueIndex = thePQ.find(newVert); // got edge's index
    if(queueIndex != -1) // if there is one,
    { // get edge
        Edge tempEdge = thePQ.peekN(queueIndex);
        int oldDist = tempEdge.distance;
        if(oldDist > newDist) // if new edge shorter,
        {
            thePQ.removeN(queueIndex); // remove old edge
            Edge theEdge = new Edge(currentVert, newVert,
newDist);
            thePQ.insert(theEdge); // insert new edge
        }
        // else no action; just leave the old vertex there
    } // end if
    else // no edge with same destination vertex
    { // so insert new one
        Edge theEdge = new Edge(currentVert, newVert, newDist);
        thePQ.insert(theEdge);
    }

    } // end putInPQ()
```

The `mstw.java` Program

The `PriorityQ` class uses an array to hold the members. As we noted, in a program dealing with large graphs a heap would be more appropriate than the array shown here. The `PriorityQ` class has been augmented with various methods. It can, as we've seen, find an edge with a given destination vertex with `find()`. It can also peek at an arbitrary member with `peekN()` and remove an arbitrary member with `removeN()`. Most of the rest of this program you've seen before. Listing 14.1 shows the complete `mstw.java` program.

Listing 14.1 The mstw.java Program

```
// mstw.java
// demonstrates minimum spanning tree with weighted graphs
// to run this program: C>java MSTWApp
import java.awt.*;
////////////////////////////////////
class Edge
{
    public int srcVert;    // index of a vertex starting edge
    public int destVert;  // index of a vertex ending edge
    public int distance;  // distance from src to dest

    public Edge(int sv, int dv, int d) // constructor
    {
        srcVert = sv;
        destVert = dv;
        distance = d;
    }
} // end class Edge

////////////////////////////////////

class PriorityQ
{
    // array in sorted order, from max at 0 to min at size-1
    private final int SIZE = 20;
    private Edge[] queArray;
    private int size;

    public PriorityQ() // constructor
    {
        queArray = new Edge[SIZE];
        size = 0;
    }

    public void insert(Edge item) // insert item in sorted
order
    {
        int j;

        for(j=0; j<size; j++) // find place to insert
            if( item.distance >= queArray[j].distance )
                break;

        for(int k=size-1; k>=j; k--) // move items up
            queArray[k+1] = queArray[k];

        queArray[j] = item; // insert item
        size++;
    }

    public Edge removeMin() // remove minimum item
```

```

        { return queArray[--size]; }

public void removeN(int n)          // remove item at n
{
    for(int j=n; j<size-1; j++)    // move items down
        queArray[j] = queArray[j+1];
    size--;
}

public Edge peekMin()              // peek at minimum item
{ return queArray[size-1]; }

public int size()                  // return number of items
{ return size; }

public boolean isEmpty()           // true if queue is empty
{ return (size==0); }

public Edge peekN(int n)           // peek at item n
{ return queArray[n]; }

public int find(int findDex)       // find item with specified
{                                  // destVert value
    for(int j=0; j<size; j++)
        if(queArray[j].destVert == findDex)
            return j;
    return -1;
}
} // end class PriorityQ

////////////////////////////////////

class Vertex
{
    public char label;              // label (e.g. 'A')
    public boolean isInTree;

// -----
-
    public Vertex(char lab)        // constructor
    {
        label = lab;
        isInTree = false;
    }

// -----
-
} // end class Vertex

////////////////////////////////////

class Graph
{

```

```

private final int MAX_VERTS = 20;
private final int INFINITY = 1000000;
private Vertex vertexList[]; // list of vertices
private int adjMat[][];      // adjacency matrix
private int nVerts;         // current number of vertices
private int currentVert;
private PriorityQ thePQ;
private int nTree;          // number of verts in tree

// -----
-
public Graph()              // constructor
{
    vertexList = new Vertex[MAX_VERTS];
                                // adjacency matrix
    adjMat = new int[MAX_VERTS][MAX_VERTS];
    nVerts = 0;
    for(int j=0; j<MAX_VERTS; j++) // set adjacency
        for(int k=0; k<MAX_VERTS; k++) // matrix to 0
            adjMat[j][k] = INFINITY;
    thePQ = new PriorityQ();
} // end constructor

// -----
-
public void addVertex(char lab)
{
    vertexList[nVerts++] = new Vertex(lab);
}

// -----
-
public void addEdge(int start, int end, int weight)
{
    adjMat[start][end] = weight;
    adjMat[end][start] = weight;
}

// -----
-
public void displayVertex(int v)
{
    System.out.print(vertexList[v].label);
}

// -----
-
public void mstw()          // minimum spanning tree
{
    currentVert = 0;        // start at 0

    while(nTree < nVerts-1) // while not all verts in tree
    {
        // put currentVert in tree
        vertexList[currentVert].isInTree = true;
    }
}

```



```

nTree++;

// insert edges adjacent to currentVert into PQ
for(int j=0; j<nVerts; j++) // for each vertex,
{
    if(j==currentVert) // skip if it's us
        continue;
    if(vertexList[j].isInTree) // skip if in the tree
        continue;
    int distance = adjMat[currentVert][j];
    if( distance == INFINITY) // skip if no edge
        continue;
    putInPQ(j, distance); // put it in PQ (maybe)
}
if(thePQ.size()==0) // no vertices in PQ?
{
    System.out.println(" GRAPH NOT CONNECTED");
    return;
}
// remove edge with minimum distance, from PQ
Edge theEdge = thePQ.removeMin();
int sourceVert = theEdge.srcVert;
currentVert = theEdge.destVert;

// display edge from source to current
System.out.print( vertexList[sourceVert].label );
System.out.print( vertexList[currentVert].label );
System.out.print(" ");
} // end while(not all verts in tree)

// mst is complete
for(int j=0; j<nVerts; j++) // unmark vertices
    vertexList[j].isInTree = false;
} // end mstw

// -----
-
public void putInPQ(int newVert, int newDist)
{
    // is there another edge with the same destination
vertex?
    int queueIndex = thePQ.find(newVert);
    if(queueIndex != -1) // got edge's index
    {
        Edge tempEdge = thePQ.peekN(queueIndex); // get edge
        int oldDist = tempEdge.distance;
        if(oldDist > newDist) // if new edge shorter,
        {
            thePQ.removeN(queueIndex); // remove old edge
            Edge theEdge =
                new Edge(currentVert, newVert,
newDist);
            thePQ.insert(theEdge); // insert new edge

```

```

        }
        // else no action; just leave the old vertex there
    } // end if
else // no edge with same destination vertex
    {
        // so insert new one
        Edge theEdge = new Edge(currentVert, newVert,
newDist);
        thePQ.insert(theEdge);
    }
} // end putInPQ()

// -----
-
} // end class Graph

////////////////////////////////////

class MSTWApp
{
    public static void main(String[] args)
    {
        Graph theGraph = new Graph();
        theGraph.addVertex('A'); // 0 (start for mst)
        theGraph.addVertex('B'); // 1
        theGraph.addVertex('C'); // 2
        theGraph.addVertex('D'); // 3
        theGraph.addVertex('E'); // 4
        theGraph.addVertex('F'); // 5

        theGraph.addEdge(0, 1, 6); // AB 6
        theGraph.addEdge(0, 3, 4); // AD 4
        theGraph.addEdge(1, 2, 10); // BC 10
        theGraph.addEdge(1, 3, 7); // BD 7
        theGraph.addEdge(1, 4, 7); // BE 7
        theGraph.addEdge(2, 3, 8); // CD 8
        theGraph.addEdge(2, 4, 5); // CE 5
        theGraph.addEdge(2, 5, 6); // CF 6
        theGraph.addEdge(3, 4, 12); // DE 12
        theGraph.addEdge(4, 5, 7); // EF 7

        System.out.print("Minimum spanning tree: ");
        theGraph.mstw(); // minimum spanning tree
        System.out.println();
    } // end main()
} // end class MSTWApp

////////////////////////////////////

```

The main() routine in class MSTWApp creates the tree in [Figure 14.1](#). Here's the output:

```
Minimum spanning tree: AD AB BE EC CF
```

The Shortest-Path Problem

Perhaps the most commonly encountered problem associated with weighted graphs is that of finding the shortest path between two given vertices. The solution to this problem is applicable to a wide variety of real-world situations, from the layout of printed circuit boards to project scheduling. It is a more complex problem than we've seen before, so let's start by looking at a (somewhat) real-world scenario in the same mythical country of Magnaguena introduced in the last section.

The Railroad Line

This time we're concerned with railroads rather than cable TV. However, this project is not as ambitious as the last one. We're not going to build the railroad; it already exists. We just want to find the cheapest route from one city to another.

The railroad charges passengers a fixed fare to travel between any two towns. These fares are shown in Figure 14.6. That is, from Ajo to Bordo is \$50, from Bordo to Danza is \$90, and so on. These rates are the same whether the ride between two towns is part of a longer itinerary or not (unlike the situation with today's airline fares).

The edges in Figure 14.6 are *directed*. They represent single-track railroad lines, on which (in the interest of safety) travel is permitted in only one direction. For example, you can go directly from Ajo to Bordo, but not from Bordo to Ajo.

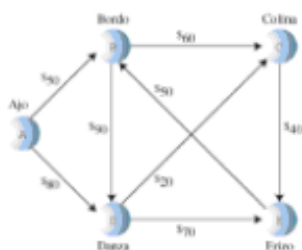

Figure 14.6: Train fares in Magnaguena

Although in this situation we're interested in the cheapest fares, the graph problem is nevertheless always referred to as the *shortest path problem*. Here *shortest* doesn't necessarily mean shortest in terms of distance; it can also mean cheapest, fastest, or best route by some other measure.

Cheapest Fares

There are several possible routes between any two towns. For example, to take the train from Ajo to Erizo you could go through Danza, or you could go through Bordo and Colina, or through Danza and Colina, or you could take several other routes. (It's not possible to reach the town of Flor by rail because it lies beyond the rugged Sierra Descaro range, so it doesn't appear on the graph. This is fortunate, because it reduces the size of certain lists we'll need to make.)

The shortest-path problem is, for a given starting point and destination, what's the cheapest route? In Figure 14.6, you can see (with a little mental effort) that the cheapest route from Ajo to Erizo passes through Danza and Colina; it will cost you \$140.

A Directed, Weighted Graph

As we noted, our railroad has only single-track lines, so you can go in only one direction between any two cities. This corresponds to a directed graph. We could have portrayed the more realistic situation in which you can go either way between two cities for the same price; this would correspond to a nondirected graph. However, the

shortest-path problem is similar in these cases, so for variety we'll show how it looks in a directed graph.

Dijkstra's Algorithm

The solution we'll show for the shortest-path problem is called Dijkstra's Algorithm, after Edsger Dijkstra, who first described it in 1959. This algorithm is based on the adjacency matrix representation of a graph. Somewhat surprisingly, it finds not only the shortest path from one specified vertex to another, but the shortest paths from the specified vertex to all the other vertices.

Agents and Train Rides

To see how Dijkstra's Algorithm works, imagine that you want to find the cheapest way to travel from Ajo to all the other towns in Magnaguena. You (and various agents you will hire) are going to play the role of the computer program carrying out Dijkstra's Algorithm. Of course in real life you could probably obtain a schedule from the railroad with all the fares. The Algorithm, however, must look at one piece of information at a time, so (as in the last section) we'll assume that you are similarly unable to see the big picture.

At each town, the stationmaster can tell you how much it will cost to travel to the other towns that you can reach directly (that is, in a single ride, without passing through another town). Alas, he cannot tell you the fares to towns further than one ride away. You keep a notebook, with a column for each town. You hope to end up with each column showing the cheapest route from your starting point to that town.

The First Agent: In Ajo

Eventually you're going to place an agent in every town; this agent's job is to obtain information about ticket costs to other towns. You yourself are the agent in Ajo.

All the stationmaster in Ajo can tell you is that it will cost \$50 to ride to Bordo, and \$80 to ride to Danza. You write this in your notebook, as shown in Table 14.2.

Table 14.2:
Step 1: An agent at Ajo

From Ajo to→	Bordo	Colina	Danza	Erizo
Step 1	50 (via Ajo)	inf	80 (via Ajo)	inf

The entry "inf" is short for "infinity," and means that you can't get from Ajo to the town shown in the column head, or at least that you don't yet know how to get there. (In the algorithm infinity will be represented by a very large number, which will help with calculations, as we'll see.) The entries in the table in parentheses are the last town visited before you arrive at the various destinations. We'll see later why this is good to know. What do you do now? Here's the rule you'll follow:

REMEMBER

Rule: Always send an agent to the town whose overall fare from the starting point (Ajo) is the cheapest.

You don't consider towns that already have an agent. Notice that this is not the same rule as that used in the minimum spanning tree problem (the cable TV installation). There, you picked the least expensive single *link* (edge) from the connected towns to an unconnected town. Here, you pick the least expensive *total route* from Ajo to a town with no agent. In this particular point in your investigation these two approaches amount to the same thing, because all known routes from Ajo consist of only one edge; but as you send agents to more towns, the routes from Ajo will become the sum of several direct edges.

The Second Agent: In Bordo

The cheapest fare from Ajo is to Bordo, at \$50. So you hire a passerby and send him to Bordo, where he'll be your agent. Once he's there, he calls you by telephone, and tells you that the Bordo stationmaster says it costs \$60 to ride to Colina and \$90 to Danza.

Doing some quick arithmetic, you figure it must be \$50 plus \$60, or \$110 to go from Ajo to Colina via Bordo, so you modify the entry for Colina. You also can see that, going via Bordo, it must be \$50 plus \$90, or \$140, from Ajo to Danza. However—and this is a key point—you already know it's only \$80 going directly from Ajo to Danza. You only care about the *cheapest* route from Ajo, so you ignore the more expensive route, leaving this entry as it was. The resulting notebook entries are shown in the last row in Table 14.3. Figure 14.7 shows the situation geographically.

Table 14.3:
Step 2: Agents at Ajo and Bordo

From Ajo to→	Bordo	Colina	Danza	Erizo
Step 1	50 (via Ajo)	inf	80 (via Ajo)	inf
Step 2	50 (via Ajo)*	110 (via Bordo)	80 (via Ajo)	inf

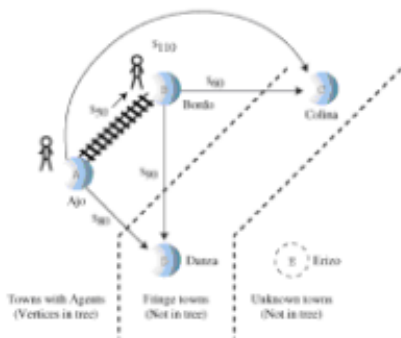

Figure 14.7: Following step 2 in the shortest-path algorithm

Once we've installed an agent in a town, we can be sure that the route taken by the agent to get to that town is the cheapest route. Why? Consider the present case. If there were a cheaper route than the direct one from Ajo to Bordo, it would need to go through some other town. But the only other way out of Ajo is to Danza, and that ride is already more expensive than the direct route to Bordo. Adding additional fares to get from Danza

to Bordo would make the Danza route still more expensive.

From this we decide that from now on we won't need to update the entry for the cheapest fare from Ajo to Bordo. This fare will not change, no matter what we find out about other towns. We'll put an * next to it to show that there's an agent in the town and that the cheapest fare to it is fixed.

Three Kinds of Town

As in the minimum spanning tree algorithm, we're dividing the towns into three categories:

1. Towns in which we've installed an agent; they're in the tree.
2. Towns with known fares from towns with an agent; they're on the fringe.
3. Unknown towns.

At this point Ajo and Bordo are category 1 towns because there are agents there. Category 1 towns form a tree consisting of paths that all begin at the starting vertex and that each end on a different destination vertex. (This is not the same tree, of course, as a minimum spanning tree.)

Some other towns have no agents, but you know the fares to them because you have agents in adjacent category 1 towns. You know the fare from Ajo to Danza is \$80, and from Bordo to Colina is \$60. Because the fares to them are known, Danza and Colina are category 2 (fringe) towns.

You don't know anything yet about Erizo, it's an "unknown" town. [Figure 14.7](#) shows these categories at the current point in the algorithm.

As in the minimum spanning tree algorithm, the algorithm moves towns from the unknown category to the fringe category, and from the fringe category to the tree, as it goes along.

The Third Agent: In Danza

At this point, the cheapest route you know that goes from Ajo to any town without an agent is \$80, the direct route from Ajo to Danza. Both the Ajo–Bordo–Colina route at \$110, and the Ajo–Bordo–Danza route at \$140, are more expensive.

You hire another passerby and send her to Danza with an \$80 ticket. She reports that from Danza it's \$20 to Colina and \$70 to Erizo. Now you can modify your entry for Colina. Before, it was \$110 from Ajo, going via Bordo. Now you see you can reach Colina for only \$100, going via Danza. Also, you now know a fare from Ajo to the previously unknown Erizo: it's \$150, via Danza. You note these changes, as shown in Table 14.4 and Figure 14.8.

Table 14.4:
Step 3: Agents at Ajo, Bordo, and Danza

From Ajo to→	Bordo	Colina	Danza	Erizo

Step 1	50 (via Ajo)	inf	80 (via Ajo)	inf
Step 2	50 (via Ajo)*	110 (via Bordo)	80 (via Ajo)	inf
Step 3	50 (via Ajo)*	100 (via Danza)	80 (via Ajo)*	150 (via Danza)

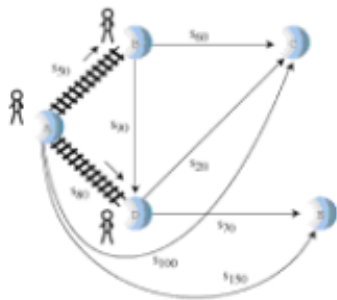

Figure 14.8: Following step 3 in the shortest-path algorithm

The Fourth Agent: In Colina

Now the cheapest path to any town without an agent is the \$100 trip from Ajo to Colina, going via Danza. Accordingly, you dispatch an agent over this route to Colina. He reports that it's \$40 from there to Erizo. Now you can calculate that, because Colina is \$100 from Ajo (via Danza), and Erizo is \$40 from Colina, you can reduce the minimum Ajo-to-Erizo fare from \$150 (the Ajo–Danza–Erizo route) to \$140 (the Ajo–Danza–Colina–Erizo route). You update your notebook accordingly, as shown in [Table 14.5](#) and [Figure 14.9](#).

Table 14.5:
Step 4: Agents in Ajo, Bordo, Danza, and Colina

From Ajo to→	Bordo	Colina	Danza	Erizo
Step 1	50 (via Ajo)	inf	80 (via Ajo)	inf
Step 2	50 (via Ajo)*	110 (via Bordo)	80 (via Ajo)	inf
Step 3	50 (via Ajo)*	100 (via Danza)	80 (via Ajo)*	150 (via Danza)
Step 4	50 (via Ajo)*	100 (via Danza)*	80 (via Ajo)*	140 (via Colina)

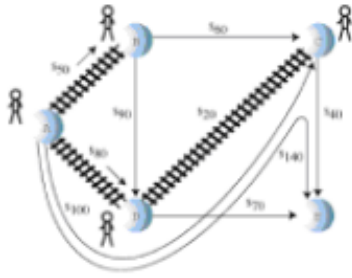

Figure 14.9: Following step 4 in the shortest-path algorithm

The Last Agent: In Erizo

The cheapest path from Ajo to any town you know about that doesn't have an agent is now \$140 to Erizo, via Danza and Colina. You dispatch an agent to Erizo, but she reports that there are no routes from Erizo to towns without agents. (There's a route to Bordo, but Bordo has an agent.) Table 14.6 shows the final line in your notebook; all you've done is add a star to the Erizo entry to show there's an agent there.

Table 14.6:
Step 5: Agents in Ajo, Bordo, Danza, Colina, and Erizo

From Ajo to →	Bordo	Colina	Danza	Erizo
Step 1	50 (via Ajo)	inf	80 (via Ajo)	inf
Step 2	50 (via Ajo)*	110 (via Bordo)	80 (via Ajo)	inf
Step 3	50 (via Ajo)*	100 (via Danza)	80 (via Ajo)*	150 (via Danza)
Step 4	50 (via Ajo)*	100 (via Danza)*	80 (via Ajo)*	140 (via Colina)
Step 5	50 (via Ajo)*	100 (via Danza)*	80 (via Ajo)*	140 (via Colina)*

When there's an agent in every town, you know the fares from Ajo to every other town. So you're done. With no further calculations, the last line in your notebook shows the cheapest routes from Ajo to all other towns.

This narrative has demonstrated the essentials of Dijkstra's Algorithm. The key points are

- Each time you send an agent to a new town, you use the new information provided by that agent to revise your list of fares. Only the cheapest fare (that you know about) from the starting point to a given town is retained.
- You always send the new agent to the town that has the cheapest path from the starting point. (Not the cheapest edge from any town with an agent, as in the minimum

spanning tree.)

Using the Workshop Applet

Let's see how this looks using the GraphDW (for Directed and Weighted) Workshop applet. Use the applet to create the graph from [Figure 14.6](#). The result should look something like Figure 14.10. (We'll see how to make the table appear below the graph in a moment.) This is a weighted, directed graph, so to make an edge, you must type a number before dragging, and you must drag in the correct direction, from the start to the destination.

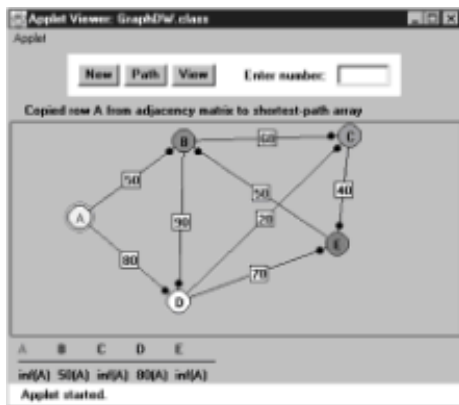

Figure 14.10: The railroad scenario in GraphDW

When the graph is complete, click the Path button, and when prompted, click the A vertex. A few more clicks on Path will place A in the tree, shown with a red circle around A.

The Shortest-Path Array

An additional click will install a table under the graph, as you can see in [Figure 14.10](#). The corresponding message near the top of the figure is `Copied row A from adjacency matrix to shortest-path array`. Dijkstra's Algorithm starts by copying the appropriate row of the adjacency matrix (that is, the row for the starting vertex) to an array. (Remember that you can examine the adjacency matrix at any time by pressing the View button.)

This array is called the "shortest-path" array. It corresponds to the most recent row of notebook entries you made while determining the cheapest train fares in Magnaguena. This array will hold the current versions of the shortest paths to the other vertices, which we can call the *destination* vertices. These destination vertices are represented by the column heads in the table.

Table 14.7:
Step 1: The Shortest-Path Array

A	B	C	D	E
inf(A)	50(A)	inf(A)	80(A)	inf(A)



In the applet, the shortest-path figures in the array are followed by the *parent vertex* enclosed in parentheses. The parent is the vertex you reached just before you reached the destination vertex. In this case the parents are all A because we've only moved one edge away from A.

If a fare is unknown (or meaningless, as from A to A) it's shown as infinity, represented by "inf," as in the rail-fare notebook entries. Notice that the column heads of those vertices that have already been added to the tree are shown in red. The entries for these columns won't change.

Minimum Distance

Initially, the algorithm knows the distances from A to other vertices that are exactly one edge from A. Only B and D are adjacent to A, so they're the only ones whose distances are shown. The algorithm picks the minimum distance. Another click on Path will show you the message

```
Minimum distance from A is 50, to vertex B
```

The algorithm adds this vertex to the tree, so the next click will show you

```
Added vertex B to tree
```

Now B is circled in the graph, and the B column head is in red. The edge from A to B is made darker to show it's also part of the tree.

Column by Column in the Shortest-Path Array

Now the algorithm knows, not only all the edges from A, but the edges from B as well. So it goes through the shortest-path array, column by column, checking whether a shorter path than that shown can be calculated using this new information. Vertices that are already in the tree, here A and B, are skipped. First column C is examined.

You'll see the message

```
To C: A to B (50) plus edge BC (60) less than A to C (inf)
```

The algorithm has found a shorter path to C than that shown in the array. The array shows infinity in the C column. But from A to B is 50 (which the algorithm finds in the B column in the shortest-path array) and from B to C is 60 (which it finds in row B column C in the adjacency matrix). The sum is 110. The 110 distance is less than infinity, so the algorithm updates the shortest-path array for column C, inserting 110.

This is followed by a B in parentheses, because that's the last vertex before reaching C; B is the parent of C.

Next the D column is examined. You'll see the message

```
To D: A to B (50) plus edge BD (90) greater than or equal to A  
to D (80)
```

The algorithm is comparing the previously shown distance from A to D, which is 80 (the direct route), with a possible route via B (that is, A-B-D). But path A-B is 50 and edge BD is 90, so the sum is 140. This is bigger than 80, so 80 is not changed.

For column E, the message is

```
To E: A to B (50) plus edge BE (inf) greater than or equal to A
to E
(inf)
```

The newly calculated route from A to E via B (50 plus infinity) is still greater than or equal to the current one in the array (infinity), so the E column is not changed. The shortest-path array now looks like Table 14.8.

Table 14.8:
Step 2: The Shortest-Path Array

A	B	C	D	E
inf(A)	50(A)	110(B)	80(A)	inf(A)

Now we can see more clearly the role played by the parent vertex shown in parentheses after each distance. Each column shows the distance from A to an ending vertex. The parent is the immediate predecessor of the ending vertex along the path from A. In column C, the parent vertex is B, meaning that the shortest path from A to C passes through B just before it gets to C. This information is used by the algorithm to place the appropriate edge in the tree. (When the distance is infinity, the parent vertex is meaningless and is shown as A.)

New Minimum Distance

Now that the shortest-path array has been updated, the algorithm finds the shortest distance in the array, as you will see with another Path key press. The message is

```
Minimum distance from A is 80, to vertex D
```

Accordingly, the message

```
Added vertex D to tree
```

appears and the new vertex and edge AC are added to the tree.

Do It Again, and Again

Now the algorithm goes through the shortest-path array again, checking and updating the distances for destination vertices not in the tree; only C and E are still in this category. Column C and E are both updated. The result is shown in Table 14.9.

Table 14.9:
Step 3: The Shortest-Path Array

--	--	--	--	--

A	B	C	D	E
inf(A)	50(A)	100(D)	80(A)	150(D)

The shortest path from A to a non-tree vertex is 100, to vertex C, so C is added to the tree.

Next time through the shortest-path array, only the distance to E is considered. It can be shortened by going via C, so we have the entries shown in Table 14.10.

Table 14.10:
Step 4: The Shortest-Path Array

A	B	C	D	E
inf(A)	50(A)	100(D)	80(A)	140(C)

Now the last vertex, E, is added to the tree, and you're done. The shortest-path array shows the shortest distances from A to all the other vertices. The tree consists of all the vertices and the edges AB, AD, DC, and CE, shown with thick lines.

You can work backward to reconstruct the sequence of vertices along the shortest path to any vertex. For the shortest path to E, for example, the parent of E, shown in the array in parentheses, is C. The predecessor of C, again from the array, is D, and the predecessor of D is A. So the shortest path from A to E follows the route A–D–C–E.

Experiment with other graphs using GraphDW, starting with small ones. You'll find that after a while you can predict what the algorithm is going to do, and you'll be on your way to understanding Dijkstra's Algorithm.

Java Code

The code for the shortest-path algorithm is among the most complex in this book, but even so it's not beyond mere mortals. We'll look first at a helper class and then at the chief method that executes the algorithm, `path()`, and finally at two methods called by `path()` to carry out specialized tasks.

The `sPath` Array and the `DistPar` Class

As we've seen, the key data structure in the shortest-path algorithm is an array that keeps track of the minimum distances from the starting vertex to the other vertices (destination vertices). During the execution of the algorithm these distances are changed, until at the end they hold the actual shortest distances from the start. In the example code, this array is called `sPath[]` (for shortest paths).

As we've seen, it's important to record not only the minimum distance from the starting

vertex to each destination vertex, but also the path taken. Fortunately, the entire path need not be explicitly stored. It's only necessary to store the parent of the destination vertex. The parent is the vertex reached just before the destination. We've seen this in the workshop applet, where, if 100(D) appears in the C column, it means that the cheapest path from A to C is 100, and D is the last vertex before C on this path.

There are several ways to keep track of the parent vertex, but we choose to combine the parent with the distance and put the resulting object into the `sPath[]` array. We call this class of objects `DistPar` (for distance-parent).

```
class DistPar          // distance and parent
{
    // items stored in sPath array
    public int distance; // distance from start to this vertex
    public int parentVert; // current parent of this vertex

    public DistPar(int pv, int d) // constructor
    {
        distance = d;
        parentVert = pv;
    }
}
```

The path () Method

The `path()` method carries out the actual shortest-path algorithm. It uses the `DistPar` class and the `Vertex` class, which we saw in the `mstw.java` program earlier in this chapter. The `path()` method is a member of the `graph` class, which we also saw in `mstw.java` in a somewhat different version.

```
public void path()          // find all shortest paths
{
    int startTree = 0;          // start at vertex 0
    vertexList[startTree].isInTree = true;
    nTree = 1;                // put it in tree

    // transfer row of distances from adjMat to sPath
    for(int j=0; j<nVerts; j++)
    {
        int tempDist = adjMat[startTree][j];
        sPath[j] = new DistPar(startTree, tempDist);
    }

    // until all vertices are in the tree
    while(nTree < nVerts)
    {
        int indexMin = getMin(); // get minimum from sPath
        int minDist = sPath[indexMin].distance;

        if(minDist == INFINITY) // if all infinite
        {
            // or in tree,
            System.out.println("There are unreachable vertices");
            break; // sPath is complete
        }
    }
}
```

```

else
    {
        // reset currentVert
        currentVert = indexMin; // to closest vert
        startToCurrent = sPath[indexMin].distance;
        // minimum distance from startTree is
        // to currentVert, and is startToCurrent
    }
// put current vertex in tree
vertexList[currentVert].isInTree = true;
nTree++;
adjust_sPath(); // update sPath[] array
} // end while(nTree<nVerts)

displayPaths(); // display sPath[] contents

nTree = 0; // clear tree
for(int j=0; j<nVerts; j++)
    vertexList[j].isInTree = false;

} // end path()

```

The starting vertex is always at index 0 of the `vertexList[]` array. The first task in `path()` is to put this vertex into the tree. As the algorithm proceeds we'll be moving other vertices into the tree as well. The `Vertex` class contains a flag that indicates whether a vertex object is in the tree. Putting a vertex in the tree consists of setting this flag and incrementing `nTree`, which counts how many vertices are in the tree.

Second, `path()` copies the distances from the appropriate row of the adjacency matrix to `sPath[]`. This is always row 0, because for simplicity we assume 0 is the index of the starting vertex. Initially, the parent field of all the `sPath[]` entries is A, the starting vertex.

We now enter the main `while` loop of the algorithm. This loop terminates when all the vertices have been placed in the tree. There are basically three actions in this loop:

1. Choose the `sPath[]` entry with the minimum distance.
2. Put the corresponding vertex (the column head for this entry) in the tree. This becomes the "current vertex" `currentVert`.
3. Update all the `sPath[]` entries to reflect distances from `currentVert`.

If `path()` finds that the minimum distance is infinity, it knows that there are vertices that are unreachable from the starting point. Why? Because not all the vertices are in the tree (the `while` loop hasn't terminated), and yet there's no way to get to these extra vertices; if there were, there would be a non-infinite distance.

Before returning, `path()` displays the final contents of `sPath[]` by calling the `displayPaths()` method. This is the only output from the program. Also, `path()` sets `nTree` to 0 and removes the `isInTree` flags from all the vertices, in case they might be used again by another algorithm (although they aren't in this program).

Finding the Minimum Distance with `getMin()`

To find the `sPath[]` entry with the minimum distance, `path()` calls the `getMin()`

method. This routine is straightforward; it steps across the `sPath[]` entries and returns with the column number (the array index) of the entry with the minimum distance.

```
public int getMin()                // get entry from sPath
{                                  // with minimum distance
    int minDist = INFINITY;        // assume large minimum
    int indexMin = 0;
    for(int j=1; j<nVerts; j++)    // for each vertex,
    {                              // if it's in tree and
        if( !vertexList[j].isInTree && // smaller than old one
            sPath[j].distance < minDist )
        {
            minDist = sPath[j].distance;
            indexMin = j;          // update minimum
        }
    } // end for
    return indexMin;              // return index of minimum
} // end getMin()
```

We could have used a priority queue as the basis for the shortest-path algorithm, as we did in the last section to find the minimum spanning tree. If we had, the `getMin()` method would not have been necessary; the minimum-weight edge would have appeared automatically at the front of the queue. However, the array approach shown makes it easier to see what's going on.

Updating `sPath[]` with `adjust_sPath()`

The `adjust_sPath()` method is used to update the `sPath[]` entries to reflect new information obtained from the vertex just inserted in the tree. When this routine is called, `currentVert` has just been placed in the tree, and `startToCurrent` is the current entry in `sPath[]` for this vertex. The `adjust_sPath()` method now examines each vertex entry in `sPath[]`, using the loop counter `column` to point to each vertex in turn.

For each `sPath[]` entry, provided the vertex is not in the tree, it does three things:

1. It adds the distance to the current vertex (already calculated and now in `startToCurrent`) to the edge distance from `currentVert` to the `column` vertex. We call the result `startToFringe`.
2. It compares `startToFringe` with the current entry in `sPath[]`.
3. If `startToFringe` is less, it replaces the entry in `sPath[]`.

This is the heart of Dijkstra's Algorithm. It keeps `sPath[]` updated with the shortest distances to all the vertices that are currently known. Here's the code for `adjust_sPath()`:

```
public void adjust_sPath()
{
    // adjust values in shortest-path array sPath
    int column = 1;                // skip starting vertex
    while(column < nVerts)        // go across columns
    {
        // if this column's vertex already in tree, skip it
    }
}
```

```

    if( vertexList[column].isInTree )
    {
        column++;
        continue;
    }
    // calculate distance for one sPath entry
        // get edge from currentVert to column
    int currentToFringe = adjMat[currentVert][column];
        // add distance from start
    int startToFringe = startToCurrent + currentToFringe;
        // get distance of current sPath entry
    int sPathDist = sPath[column].distance;

    // compare distance from start with sPath entry
    if(startToFringe < sPathDist) // if shorter,
    {
        // update sPath
        sPath[column].parentVert = currentVert;
        sPath[column].distance = startToFringe;
    }
    column++;
} // end while(column < nVerts)

} // end adjust_sPath()

```

The `main()` routine in the `path.java` program creates the tree of [Figure 14.6](#) and displays its shortest-path array. Here's the code:

```

public static void main(String[] args)
{
    Graph theGraph = new Graph();
    theGraph.addVertex('A'); // 0 (start)
    theGraph.addVertex('B'); // 1
    theGraph.addVertex('C'); // 2
    theGraph.addVertex('D'); // 3
    theGraph.addVertex('E'); // 4

    theGraph.addEdge(0, 1, 50); // AB 50
    theGraph.addEdge(0, 3, 80); // AD 80
    theGraph.addEdge(1, 2, 60); // BC 60
    theGraph.addEdge(1, 3, 90); // BD 90
    theGraph.addEdge(2, 4, 40); // CE 40
    theGraph.addEdge(3, 2, 20); // DC 20
    theGraph.addEdge(3, 4, 70); // DE 70
    theGraph.addEdge(4, 1, 50); // EB 50

    System.out.println("Shortest paths");
    theGraph.path(); // shortest paths
    System.out.println();

} // end main()

```

The output of this program is

A=inf(A) B=50(A) C=100(D) D=80(A) E=140(C)

The path.java Program

Listing 14.2 is the complete code for the path.java program. Its various components were all discussed earlier.

Listing 14.2 The path.java Program

```
// path.java
// demonstrates shortest path with weighted, directed graphs
// to run this program: C>java PathApp
import java.awt.*;
////////////////////////////////////
class DistPar          // distance and parent
{
    // items stored in sPath array
    public int distance; // distance from start to this vertex
    public int parentVert; // current parent of this vertex

    public DistPar(int pv, int d) // constructor
    {
        distance = d;
        parentVert = pv;
    }
} // end class DistPar

////////////////////////////////////

class Vertex
{
    public char label; // label (e.g. 'A')
    public boolean isInTree;

// -----
-
    public Vertex(char lab) // constructor
    {
        label = lab;
        isInTree = false;
    }

// -----
-
} // end class Vertex

////////////////////////////////////

class Graph
{
    private final int MAX_VERTS = 20;
    private final int INFINITY = 1000000;
    private Vertex vertexList[]; // list of vertices
    private int adjMat[][]; // adjacency matrix
```

```

private int nVerts;           // current number of vertices
private int nTree;           // number of verts in tree
private DistPar sPath[];     // array for shortest-path data
private int currentVert;     // current vertex
private int startToCurrent;  // distance to currentVert

// -----
-
public Graph()               // constructor
{
    vertexList = new Vertex[MAX_VERTS];
                                // adjacency matrix
    adjMat = new int[MAX_VERTS][MAX_VERTS];
    nVerts = 0;
    nTree = 0;
    for(int j=0; j<MAX_VERTS; j++) // set adjacency
        for(int k=0; k<MAX_VERTS; k++) // matrix
            adjMat[j][k] = INFINITY; // to infinity
    sPath = new DistPar[MAX_VERTS]; // shortest paths
} // end constructor

// -----
-
public void addVertex(char lab)
{
    vertexList[nVerts++] = new Vertex(lab);
}

// -----
-
public void addEdge(int start, int end, int weight)
{
    adjMat[start][end] = weight; // (directed)
}

// -----
-
public void path()           // find all shortest paths
{
    int startTree = 0;      // start at vertex 0
    vertexList[startTree].isInTree = true;
    nTree = 1;             // put it in tree

    // transfer row of distances from adjMat to sPath
    for(int j=0; j<nVerts; j++)
    {
        int tempDist = adjMat[startTree][j];
        sPath[j] = new DistPar(startTree, tempDist);
    }

    // until all vertices are in the tree
    while(nTree < nVerts)
    {
        int indexMin = getMin(); // get minimum from sPath

```

```

        int minDist = sPath[indexMin].distance;

        if(minDist == INFINITY)        // if all infinite
            {                          // or in tree,
                System.out.println("There are unreachable
vertices");
                break;                // sPath is complete
            }
        else
            {                          // reset currentVert
                currentVert = indexMin; // to closest vert
                startToCurrent = sPath[indexMin].distance;
                // minimum distance from startTree is
                // to currentVert, and is startToCurrent
            }
        // put current vertex in tree
        vertexList[currentVert].isInTree = true;
        nTree++;
        adjust_sPath();                // update sPath[] array
    } // end while(nTree<nVerts)

    displayPaths();                    // display sPath[]
contents

    nTree = 0;                          // clear tree
    for(int j=0; j<nVerts; j++)
        vertexList[j].isInTree = false;
    } // end path()

// -----
-
    public int getMin()                // get entry from sPath
    {                                  // with minimum
distance
        int minDist = INFINITY;        // assume minimum
        int indexMin = 0;
        for(int j=1; j<nVerts; j++)    // for each vertex,
            {                          // if it's in tree and
one
                if( !vertexList[j].isInTree && // smaller than old
                    sPath[j].distance < minDist )
                    {
                        minDist = sPath[j].distance;
                        indexMin = j;        // update minimum
                    }
            } // end for
        return indexMin;                // return index of minimum
    } // end getMin()

// -----
-
    public void adjust_sPath()
    {
        // adjust values in shortest-path array sPath

```

```

int column = 1;                // skip starting vertex
while(column < nVerts)        // go across columns
{
    // if this column's vertex already in tree, skip it
    if( vertexList[column].isInTree )
    {
        column++;
        continue;
    }
    // calculate distance for one sPath entry
        // get edge from currentVert to column
int currentToFringe = adjMat[currentVert][column];
        // add distance from start
int startToFringe = startToCurrent + currentToFringe;
        // get distance of current sPath entry
int sPathDist = sPath[column].distance;

    // compare distance from start with sPath entry
if(startToFringe < sPathDist) // if shorter,
    {
        // update sPath
        sPath[column].parentVert = currentVert;
        sPath[column].distance = startToFringe;
    }
    column++;
} // end while(column < nVerts)
} // end adjust_sPath()

// -----
-
public void displayPaths()
{
    for(int j=0; j<nVerts; j++) // display contents of
sPath[]
    {
        System.out.print(vertexList[j].label + "="); // B=
        if(sPath[j].distance == INFINITY)
            System.out.print("inf");                // inf
        else
            System.out.print(sPath[j].distance);    // 50
        char parent = vertexList[ sPath[j].parentVert ].label;
        System.out.print("(" + parent + " ");      // (A)
    }
    System.out.println("");
}

// -----
-
} // end class Graph

////////////////////////////////////

class PathApp
{

```

```

public static void main(String[] args)
{
    Graph theGraph = new Graph();
    theGraph.addVertex('A');    // 0 (start)
    theGraph.addVertex('C');    // 2
    theGraph.addVertex('B');    // 1
    theGraph.addVertex('D');    // 3
    theGraph.addVertex('E');    // 4

    theGraph.addEdge(0, 1, 50); // AB 50
    theGraph.addEdge(0, 3, 80); // AD 80
    theGraph.addEdge(1, 2, 60); // BC 60
    theGraph.addEdge(1, 3, 90); // BD 90
    theGraph.addEdge(2, 4, 40); // CE 40
    theGraph.addEdge(3, 2, 20); // DC 20
    theGraph.addEdge(3, 4, 70); // DE 70
    theGraph.addEdge(4, 1, 50); // EB 50

    System.out.println("Shortest paths");
    theGraph.path();           // shortest paths
    System.out.println();
} // end main()
} // end class PathApp

```

////////////////////////////////////

Efficiency

So far we haven't discussed the efficiency of the various graph algorithms. The issue is complicated by the two ways of representing graphs: the adjacency matrix and adjacency lists.

If an adjacency matrix is used, the algorithms we've discussed all require $O(V^2)$ time, where V is the number of vertices. Why? If you analyze the algorithms, you'll see that they involve examining each vertex once, and for that vertex going across its row in the adjacency matrix, looking at each edge in turn. In other words, each cell of the adjacency matrix, which has V^2 cells, is examined.

For large matrices, $O(V^2)$ isn't very good performance. If the graph is dense there isn't much we can do about improving this performance. (As we noted earlier, by *dense* we mean a graph that has many edges; one in which many or most of the cells in the adjacency matrix are filled.)

However, many graphs are *sparse*, the opposite of dense. There's no clear-cut definition of how many edges a graph must have to be described as sparse or dense, but if each vertex in a large graph is connected by only a few edges, the graph would normally be described as sparse.

In a sparse graph, running times can be improved by using the adjacency list representation rather than the adjacency matrix. This is easy to understand: you don't waste time examining adjacency matrix cells that don't hold edges.

For unweighted graphs the depth-first search with adjacency lists requires $O(V+E)$ time, where V is the number of vertices and E is the number of edges. For weighted graphs, both the minimum spanning tree and the shortest-path algorithm require $O((E+V)\log V)$ time. In large, sparse graphs these times can represent dramatic improvements over the adjacency

matrix approach. However, the algorithms are somewhat more complicated, which is why we've used the adjacency matrix approach throughout this chapter. You can consult Sedgewick (see [Appendix B, "Further Reading"](#)) and other writers for examples of graph algorithms using the adjacency list approach.

Summary

- In a weighted graph, edges have an associated number called the weight, which might represent distances, costs, times, or other quantities.
- The minimum spanning tree in a weighted graph minimizes the weights of the edges necessary to connect all the vertices.
- An algorithm using a priority queue can be used to find the minimum spanning tree of a weighted graph.
- The minimum spanning tree of a weighted graph models real-world situations such as installing utility cables between cities.
- The shortest-path problem in a nonweighted graph involves finding the minimum number of edges between two vertices.
- Solving the shortest-path problem for weighted graphs yields the path with the minimum total edge weight.
- The shortest-path problem for weighted graphs can be solved with Dijkstra's Algorithm.
- The algorithms for large, sparse graphs generally run much faster if the adjacency list representation of the graph is used rather than the adjacency matrix.

Chapter 15: When to Use What

Overview

In this chapter we briefly summarize what we've learned so far, with an eye toward deciding what data structure or algorithm to use in a particular situation.

This chapter comes with the usual caveats. Of necessity it's very general. Every real-world situation is unique, so what we say here may not be the right answer to your problem. This chapter is divided into three somewhat arbitrary sections:

- General-purpose data structures: arrays, linked lists, trees, and hash tables
- Specialized data structures: stacks, queues, priority queues, and graphs
- Sorting

For detailed information on these topics, refer to the individual chapters in this book.

General-Purpose Data Structures

If you need to store real-world data such as personnel records, inventories, contact lists, or sales data, you need a general-purpose data structure. The structures of this type that we've discussed in this book are arrays, linked lists, trees, and hash tables. We call these general-purpose data structures because they are used to store and retrieve data using

key values. This works for general-purpose database programs (as opposed to specialized structures such as stacks, which allow access to only certain data items).

Which of these general-purpose data structures is appropriate for a given problem? Figure 15.1 shows a first approximation to this question. However, there are many factors besides those shown in the figure. For more detail, we'll explore some general considerations first, and then zero in on the individual structures.

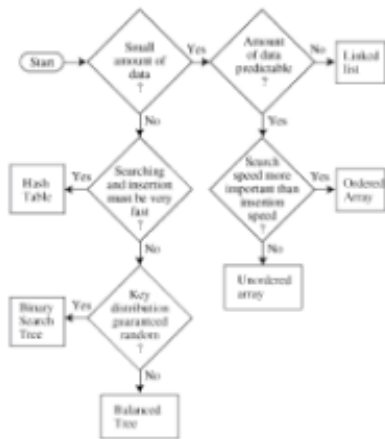

Figure 15.1: Relationship of general-purpose data structures

Speed and Algorithms

The general-purpose data structures can be roughly arranged in terms of speed: Arrays and linked lists are slow, trees are fairly fast, and hash tables are very fast.

However, don't draw the conclusion from this figure that it's always best to use the fastest structures. There's a penalty for using them. First, they are—in varying degrees—more complex to program than the array and linked list. Also, hash tables require you to know in advance about how much data can be stored, and they don't use memory very efficiently. Ordinary binary trees will revert to slow $O(N)$ operation for ordered data, and balanced trees, which avoid this problem, are difficult to program.

Computers Grow Faster Every Year

The fast structures come with penalties, and another development makes the slow structures more attractive. Every year there's an increase in the CPU and memory-access speed of the latest computers. Moore's Law (postulated by Gordon Moore in 1965) specifies that CPU performance will double every 18 months. This adds up to an astonishing difference in performance between the earliest computers and those available today, and there's no reason to think this increase will slow down any time soon.

Suppose a computer a few years ago handled an array of 100 objects in acceptable time. Now, computers are 100 times faster, so an array with 10,000 objects can run at the same speed. Many writers provide estimates of the maximum size you can make a data structure before it becomes too slow. Don't trust these estimates (including those in this book). Today's estimate doesn't apply to tomorrow.

Instead, start by considering the simple data structures. Unless it's obvious they'll be too slow, code a simple version of an array or linked list and see what happens. If it runs in acceptable time, look no further. Why slave away on a balanced tree, when no one would ever notice if you used an array instead? Even if you must deal with thousands or tens of thousands of items, it's still worthwhile to see how well an array or linked list will handle

them. Only when experimentation shows their performance to be too slow should you revert to more sophisticated data structures.

References Are Faster

Java has an advantage over some languages in the speed with which objects can be manipulated, because, in most data structures, Java stores only references, not actual objects. Therefore most algorithms will run faster than in languages where actual objects occupy space in a data structure. In analyzing the algorithms it's not the case, as when objects themselves are stored, that the time to "move" an object depends on the size of the object. Because only a reference is moved, it doesn't matter how large the object is.

Of course in other languages, such as C++, pointers to objects can be stored instead of the objects themselves; this has the same effect as using references, but the syntax is more complicated.

Libraries

Libraries of data structures are available commercially in all major programming languages. Languages themselves may have some structures built in. Java, for example, includes `Vector`, `Stack`, and `Hashtable` classes. C++ includes the Standard Template Library (STL), which contains classes for many data structures and algorithms.

Using a commercial library may eliminate or at least reduce the programming necessary to create the data structures described in this book. When that's the case, using a complex structure such as a balanced tree, or a delicate algorithm such as quicksort, becomes a more attractive possibility. However, you must ensure that the class can be adapted to your particular situation.

Arrays

In many situations the array is the first kind of structure you should consider when storing and manipulating data. Arrays are useful when

- The amount of data is reasonably small.
- The amount of data is predictable in advance.

If you have plenty of memory, you can relax the second condition; just make the array big enough to handle any foreseeable influx of data.

If insertion speed is important, use an unordered array. If search speed is important, use an ordered array with a binary search. Deletion is always slow in arrays because an average of half the items must be moved to fill in the newly vacated cell. Traversal is fast in an ordered array but not supported in an unordered array.

Vectors, such as the `Vector` class supplied with Java, are arrays that expand themselves when they become too full. Vectors may work when the amount of data isn't known in advance. However, there may periodically be a significant pause while they enlarge themselves by copying the old data into the new space.

Linked lists

Consider a linked list whenever the amount of data to be stored cannot be predicted in advance or when data will frequently be inserted and deleted. The linked list obtains whatever storage it needs as new items are added, so it can expand to fill all of available memory; and there is no need to fill "holes" during deletion, as there is in arrays.

Insertion is fast in an unordered list. Searching and deletion are slow (although deletion is faster than in an array), so, like arrays, linked lists are best used when the amount of data is comparatively small.

A linked list is somewhat more complicated to program than an array, but is simple compared with a tree or hash table.

Binary Search Trees

A binary tree is the first structure to consider when arrays and linked lists prove too slow. A tree provides fast $O(\log N)$ insertion, searching, and deletion. Traversal is $O(N)$, which is the maximum for any data structure (by definition, you must visit every item). You can also find the minimum and maximum quickly, and traverse a range of items.

An unbalanced binary tree is much easier to program than a balanced tree, but unfortunately, ordered data can reduce its performance to $O(N)$ time, no better than a linked list. However, if you're sure the data will arrive in random order, there's no point using a balanced tree.

Balanced Trees

Of the various kinds of balanced trees, we discussed red-black trees and 2-3-4 trees. They are both balanced trees, and thus guarantee $O(\log N)$ performance whether the input data is ordered or not. However, these balanced trees are challenging to program, with the red-black tree being the more difficult. They also impose additional memory overhead, which may or may not be significant.

The problem of complex programming may be reduced if a commercial class can be used for a tree. In some cases a hash table may be a better choice than a balanced tree. Hash-table performance doesn't degrade when the data is ordered.

There are other kinds of balanced trees, including AVL trees, splay trees, 2-3 trees, and so on, but they are not as commonly used as the red-black tree.

Hash Tables

Hash tables are the fastest data storage structure. This makes them a necessity for situations in which a computer program, rather than a human, is interacting with the data. Hash tables are typically used in spelling checkers and as symbol tables in computer language compilers, where a program must check thousands of words or symbols in a fraction of a second.

Hash tables may also be useful when a person, as opposed to a computer, initiates data-access operations. As noted above, hash tables are not sensitive to the order in which data is inserted, and so can take the place of a balanced tree. Programming is much simpler than for balanced trees.

Hash tables require additional memory, especially for open addressing. Also, the amount of data to be stored must be known fairly accurately in advance, because an array is used as the underlying structure.

A hash table with separate chaining is the most robust implementation unless the amount of data is known accurately in advance, in which case open addressing offers simpler programming because no linked list class is required.

Hash tables don't support any kind of ordered traversal or access to the minimum or maximum items. If these capabilities are important, the binary search tree is a better choice.

Comparing the General-Purpose Storage Structures

Table 15.1 summarizes the speeds of the various general-purpose data storage structures using Big O notation.

Table 15.1: GENERAL-PURPOSE DATA STORAGE STRUCTURES

Data Structure	Search	Insertion	Deletion	Traversal
Array	$O(N)$	$O(1)$	$O(N)$	—
Ordered array	$O(\log N)$	$O(N)$	$O(N)$	$O(N)$
Linked list	$O(N)$	$O(1)$	$O(N)$	—
Ordered linked list	$O(N)$	$O(N)$	$O(N)$	$O(N)$
Binary tree (average)	$O(\log N)$	$O(\log N)$	$O(\log N)$	$O(N)$
Binary tree (worst case)	$O(N)$	$O(N)$	$O(N)$	$O(N)$
Balanced tree (average and worst case)	$O(\log N)$	$O(\log N)$	$O(\log N)$	$O(N)$
Hash table	$O(1)$	$O(1)$	$O(1)$	—

Insertion in an unordered array is assumed to be at the end of the array. The ordered array uses a binary search, which is fast, but insertion and deletion require moving half the items on the average, which is slow. Traversal implies visiting the data items in order of ascending or descending keys; the — means this operation is not supported.

Special-Purpose Data Structures

The special-purpose data structures discussed in this book are the stack, the queue, and the priority queue. These structures, instead of supporting a database of user-accessible data, are usually used by a computer program to aid in carrying out some algorithm. We've seen examples of this throughout this book, such as in [Chapters 13, "Graphs,"](#) and [14, "Weighted Graphs,"](#) where stacks, queues, and priority queues are all used in graph algorithms.

Stacks, queues, and priority queues are abstract data types (ADTs) that are implemented by a more fundamental structure such as an array, linked list, or (in the case of the priority queue) a heap. These ADTs present a simple interface to the user, typically allowing only insertion and the ability to access or delete only one data item. These items are

- For stacks: the last item inserted
- For queues: the first item inserted

- For priority queues: the item with the highest priority

These ADTs can be seen as conceptual aids. Their functionality could be obtained using the underlying structure (such as an array) directly, but the reduced interface they offer simplifies many problems.

These ADTs can't be conveniently searched for an item by key value or traversed.

Stack

A stack is used when you want access only to the last data item inserted; it's a last-in-first-out (LIFO) structure.

A stack is often implemented as an array or a linked list. The array implementation is efficient because the most recently inserted item is placed at the end of the array, where it's also easy to delete it. Stack overflow can occur, but is not likely if the array is reasonably sized, because stacks seldom contain huge amounts of data.

If the stack will contain a lot of data and the amount can't be predicted accurately in advance (as when recursion is implemented as a stack) a linked list is a better choice than an array. A linked list is efficient because items can be inserted and deleted quickly from the head of the list. Stack overflow can't occur (unless the entire memory is full). A linked list is slightly slower than an array because memory allocation is necessary to create a new link for insertion, and deallocation of the link is necessary at some point following removal of an item from the list.

Queue

A queue is used when you want access only to the first data item inserted; it's a first-in-first-out (FIFO) structure.

Like stacks, queues can be implemented as arrays or linked lists. Both are efficient. The array requires additional programming to handle the situation in which the queue wraps around at the end of the array. A linked list must be double-ended, to allow insertions at one end and deletions at the other.

As with stacks, the choice between an array implementation and a linked list implementation is determined by how well the amount of data can be predicted. Use the array if you know about how much data there will be; otherwise, use a linked list.

Priority queue

A priority queue is used when the only access desired is to the data item with the highest priority. This is the item with the largest (or sometimes the smallest) key.

Priority queues can be implemented as an ordered array or as a heap. Insertion into an ordered array is slow, but deletion is fast. With the heap implementation, both insertion and deletion take $O(\log N)$ time.

Use an array or a double-ended linked list if insertion speed is not a problem. The array works when the amount of data to be stored can be predicted in advance; the linked list when the amount of data is unknown. If speed is important, a heap is a better choice.

Table 15.2: SPECIAL-PURPOSE DATA-STORAGE STRUCTURES

Data Structure	Insertion	Deletion	Comment
Stack (array or linked list)	$O(1)$	$O(1)$	Deletes most recently inserted item
Queue (array or linked list)	$O(1)$	$O(1)$	Deletes least recently inserted item
Priority queue (ordered array)	$O(N)$	$O(1)$	Deletes highest-priority item
Priority queue (heap)	$O(\log N)$	$O(\log N)$	Deletes highest-priority item

Comparison of Special-Purpose Structures

Table 15.2 shows the Big O times for stacks, queues, and priority queues. These structures don't support searching or traversal.

Special-Purpose Data Structures

The special-purpose data structures discussed in this book are the stack, the queue, and the priority queue. These structures, instead of supporting a database of user-accessible data, are usually used by a computer program to aid in carrying out some algorithm. We've seen examples of this throughout this book, such as in [Chapters 13, "Graphs,"](#) and [14, "Weighted Graphs,"](#) where stacks, queues, and priority queues are all used in graph algorithms.

Stacks, queues, and priority queues are abstract data types (ADTs) that are implemented by a more fundamental structure such as an array, linked list, or (in the case of the priority queue) a heap. These ADTs present a simple interface to the user, typically allowing only insertion and the ability to access or delete only one data item. These items are

- For stacks: the last item inserted
- For queues: the first item inserted
- For priority queues: the item with the highest priority

These ADTs can be seen as conceptual aids. Their functionality could be obtained using the underlying structure (such as an array) directly, but the reduced interface they offer simplifies many problems.

These ADTs can't be conveniently searched for an item by key value or traversed.

Stack

A stack is used when you want access only to the last data item inserted; it's a last-in-first-out (LIFO) structure.

A stack is often implemented as an array or a linked list. The array implementation is efficient because the most recently inserted item is placed at the end of the array, where it's also easy to delete it. Stack overflow can occur, but is not likely if the array is reasonably sized, because stacks seldom contain huge amounts of data.

If the stack will contain a lot of data and the amount can't be predicted accurately in advance (as when recursion is implemented as a stack) a linked list is a better choice than an array. A linked list is efficient because items can be inserted and deleted quickly from the head of the list. Stack overflow can't occur (unless the entire memory is full). A linked list is slightly slower than an array because memory allocation is necessary to create a new link for insertion, and deallocation of the link is necessary at some point following removal of an item from the list.

Queue

A queue is used when you want access only to the first data item inserted; it's a first-in-first-out (FIFO) structure.

Like stacks, queues can be implemented as arrays or linked lists. Both are efficient. The array requires additional programming to handle the situation in which the queue wraps around at the end of the array. A linked list must be double-ended, to allow insertions at one end and deletions at the other.

As with stacks, the choice between an array implementation and a linked list implementation is determined by how well the amount of data can be predicted. Use the array if you know about how much data there will be; otherwise, use a linked list.

Priority queue

A priority queue is used when the only access desired is to the data item with the highest priority. This is the item with the largest (or sometimes the smallest) key.

Priority queues can be implemented as an ordered array or as a heap. Insertion into an ordered array is slow, but deletion is fast. With the heap implementation, both insertion and deletion take $O(\log N)$ time.

Use an array or a double-ended linked list if insertion speed is not a problem. The array works when the amount of data to be stored can be predicted in advance; the linked list when the amount of data is unknown. If speed is important, a heap is a better choice.

Table 15.2: SPECIAL-PURPOSE DATA-STORAGE STRUCTURES

Data Structure	Insertion	Deletion	Comment
Stack (array or linked list)	$O(1)$	$O(1)$	Deletes most recently inserted item
Queue (array or linked list)	$O(1)$	$O(1)$	Deletes least recently inserted item
Priority queue	$O(N)$	$O(1)$	Deletes highest-

(ordered array)			priority item
Priority queue (heap)	$O(\log N)$	$O(\log N)$	Deletes highest-priority item

Comparison of Special-Purpose Structures

Table 15.2 shows the Big O times for stacks, queues, and priority queues. These structures don't support searching or traversal.

Sorting

As with the choice of data structures, it's worthwhile initially to try a slow but simple sort, such as the insertion sort. It may be that the fast processing speeds available in modern computers will allow sorting of your data in reasonable time. (As a wild guess, the slow sort might be appropriate for under 1,000 items.)

Insertion sort is also good for almost-sorted files, operating in about $O(N)$ time if not too many items are out of place. This is typically the case where a few new items are added to an already sorted file.

If the insertion sort proves too slow, then the Shellsort is the next candidate. It's fairly easy to implement, and not very temperamental. Sedgewick estimates it to be useful up to 5,000 items.

Only when the Shellsort proves too slow should you use one of the more complex but faster sorts: mergesort, heapsort, or quicksort. Mergesort requires extra memory, heapsort requires a heap data structure, and both are somewhat slower than quicksort, so quicksort is the usual choice when the fastest sorting time is necessary.

However, quicksort is suspect if there's a danger that the data may not be random, in which case it may deteriorate to $O(N^2)$ performance. For potentially non-random data, heapsort is better. Quicksort is also prone to subtle errors if it is not implemented correctly. Small mistakes in coding can make it work poorly for certain arrangements of data, a situation that may be hard to diagnose.

Table 15.3: COMPARISON OF SORTING ALGORITHMS

Sort	Average	Worst	Comparison	Extra Memory
Bubble	$O(N^2)$	$O(N^2)$	Poor	No
Selection	$O(N^2)$	$O(N^2)$	Fair	No
Insertion	$O(N^2)$	$O(N^2)$	Good	No
Shellsort	$O(N^{3/2})$	$O(N^{3/2})$	—	No
Quicksort	$O(N \cdot \log N)$	$O(N^2)$	Good	No

Mergesort	$O(N \cdot \log N)$	$O(N \cdot \log N)$	Fair	Yes
Heapsort	$O(N \cdot \log N)$	$O(N \cdot \log N)$	Fair	No

Table 15.3 summarizes the running time for various sorting algorithms. The column labeled Comparison attempts to estimate the minor speed differences between algorithms with the same average Big O times. (There's no entry for Shellsort because there are no other algorithms with the same Big O performance.)

External Storage

In the previous discussion we assumed that data was stored in main memory. However, amounts of data too large to store in memory must be stored in external storage, which generally means disk files. We discussed external storage in the second parts of [Chapters 10, "2-3-4 Tables and External Storage,"](#) and [11, "Hash Tables."](#)

We assumed that data is stored in a disk file in fixed-size units called blocks, each of which holds a number of records. (A record in a disk file holds the same sort of data as an object in main memory.) Like an object, a record has a key value used to access it.

We also assumed that reading and writing operations always involve a single block, and these read and write operations are far more time-consuming than any processing of data in main memory. Thus for fast operation the number of disk accesses must be minimized.

Sequential Storage

The simplest approach is to store records randomly and read them sequentially when searching for one with a particular key. New records can simply be inserted at the end of the file. Deleted records can be marked as deleted, or records can be shifted down (as in an array) to fill in the gap.

On the average, searching and deletion will involve reading half the blocks, so sequential storage is not very fast, operating in $O(N)$ time. Still, it might be satisfactory for a small number of records.

Indexed Files

Speed is increased dramatically when indexed files are used. In this scheme an index of keys and corresponding block numbers is kept in main memory. To access a record with a specified key, the index is consulted. It supplies the block number for the key, and only one block needs to be read, taking $O(1)$ time.

Several indices with different kinds of keys can be used (one for last names, one for Social Security numbers, and so on). This scheme works well until the index becomes too large to fit in memory.

Typically the index files are themselves stored on disk and read into memory as needed.

The disadvantage of indexed files is that at some point the index must be created. This probably involves reading through the file sequentially, so creating the index is slow. Also, the index will need to be updated when items are added to the file.

B-trees

B-trees are multiway trees, commonly used in external storage, in which nodes correspond to blocks on the disk. As in other trees, the algorithms find their way down the tree, reading one block at each level. B-trees provide searching, insertion, and deletion of records in $O(\log N)$ time. This is quite fast and works even for very large files. However, the programming is not trivial.

Hashing

If it's acceptable to use about twice as much external storage as a file would normally take, then external hashing might be a good choice. It has the same access time as indexed files, $O(1)$, but can handle larger files.

Figure 15.2 shows, rather impressionistically, these choices for external storage structures.

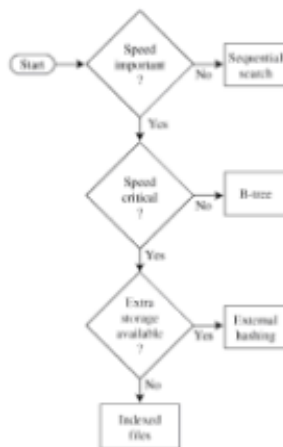

Figure 15.2: Relationship of external storage choices

Virtual Memory

Sometimes you can let your operating system's virtual memory capabilities (if it has them) solve disk access problems with little programming effort on your part.

If you read a file that's too big to fit in main memory, the virtual memory system will read in that part of the file that fits and store the rest on the disk. As you access different parts of the file, they will be read from the disk automatically and placed in memory.

You can apply internal algorithms to the entire file just as if it were all in memory at the same time, and let the operating system worry about reading the appropriate part of the file if it isn't in memory already.

Of course operation will be much slower than when the entire file is in memory, but this would also be true if you dealt with the file block by block using one of the external-storage algorithms. It may be worth simply ignoring the fact that a file does not fit in memory, and see how well your algorithms work with the help of virtual memory. Especially for files that aren't much larger than the available memory, this may be an easy solution.

Onward

We've come to the end of our survey of data structures and algorithms. The subject is large and complex, so no one book can make you an expert, but we hope this book has made it easy for you to learn about the fundamentals. [Appendix B, "Further Reading,"](#) contains suggestions for further study.

Part VI: **Appendixes**

Appendix List

[Appendix A: How to Run the Workshop Applets and Example Programs](#)

[Appendix B: Further Reading](#)

Appendix A: How to Run the Workshop Applets and Example Programs

Overview

In this appendix we discuss the details of running the Workshop applets and the example programs. The Workshop applets are graphics-based demonstration programs that show what trees and other data structures look like. The example programs, whose code is shown in the text, present runnable Java code.

The `readme.txt` file in the CD-ROM that accompanies this book contains further information on the topics discussed in this appendix. Be sure to read this file for the latest information on working with the Workshop applets and example programs.

The Java Development Kit

Both the Workshop applets and the example programs can be executed using utility programs that are part of the Sun Microsystems Java Development Kit (JDK). The JDK is included on the CD-ROM. The `readme.txt` file on the CD-ROM explains how Appendix A - How to Run the Workshop Applets and Example Programs to load the contents of the CD-ROM onto your hard drive. In this appendix we'll assume that you've transferred all appropriate files, including the JDK.

The CD-ROM contains software to support various hardware and software platforms. See the `readme.txt` file for details. We'll base this discussion on using the JDK in Microsoft Windows 95. The details of usage in other platforms may vary.

Command-line Programs

The JDK operates in text mode, using the command line to launch its various programs. In Windows 95, you'll need to open an MS-DOS box to obtain this command line. Click the Start button, and select MS-DOS Prompt from the Programs menu.

Then, in MS-DOS, use the `cd` command to move to the appropriate subdirectory on your hard disk, where either a Workshop applet or an example program is stored. Then execute the applet or program using the appropriate JDK utility as detailed below.

Setting the Path

In Windows 95, the location of the JDK utility programs should be specified in a `PATH` statement in the `autoexec.bat` file so they can be accessed conveniently from within any subdirectory. This `PATH` statement should be placed automatically in your `autoexec.bat` file when you run the setup program on your CD-ROM. Otherwise, use the Notepad utility to insert the line

```
SET PATH=C:\JDK1.1.3\BIN;%PATH%
```

into the `autoexec.bat` file, following other `SET PATH` commands. You'll find this file in your root directory. Reboot your computer to activate this new path.

Workshop Applets

An *applet* is a special kind of Java program that is easy to send over the World Wide Web. Because Java applets are designed for the Internet, they can run on any computer platform that has an appropriate applet viewer or Web browser.

In this book, the Workshop applets provide dynamic graphics-based demonstrations of the concepts discussed in the text. For example, the chapter on binary trees ([Chapter 8](#)) includes a Workshop applet that shows a tree in the applet window. Clicking buttons will show the steps involved in inserting a new node into the tree, deleting an existing node, traversing the tree, and so on. Other chapters include appropriate Workshop applets.

Files and the `appletviewer` Utility

The Workshop applets are found on the CD-ROM that accompanies this book. Each applet consists of an `.html` file and several `.class` files. These are grouped in a subdirectory that has approximately the same name as the applet itself. This subdirectory is placed within the directory for the appropriate chapter. Don't confuse the directory that holds the applets (`javaapps`) with the directory that holds the example programs (`javaprogs`).

To run the Workshop applets, first use the `cd` command to navigate to the desired subdirectory. For example, to execute the Array Workshop applet from [Chapter 2](#), move to its directory:

```
C:cd javaapps
C:cd chap02

C:cd array
```

Then use the `appletviewer` utility from the JDK to execute the applet's `.html` file:

```
C:appletviewer Array.html
```

The applet should start running. (Sometimes they take a while to load, so be patient.) The applet's appearance should be close to the screen shots shown in the text. (It won't look exactly the same because every applet viewer and browser interpret HTML and Java format somewhat differently.)

You can use various other Web browsers to execute the applets. Check the HTML and Java file on the CD-ROM to find which browsers are currently compatible.

Operating the Workshop Applets

Each chapter gives instructions for operating specific Workshop applets. In general, remember that in most cases you'll need to repeatedly click a single button to carry out an operation. Each press of the `Ins` button in the Array Workshop applet, for example, causes one step of the insertion process to be carried out. Generally a message is displayed telling what's happening at each step.

You should complete each operation—that is, each sequence of button clicks—before

clicking a different button to start a different operation. For example, keep clicking the Find button until the item with the specified key is located, and you see the message `Press any button`. Only then should you switch to another operation involving another button, such as inserting a new item with the `Ins` button.

The sorting applets from [Chapters 3](#) and [7](#) have a Step button with which you can view the sorting process one step at a time. They also have a Run mode in which the sort runs at high speed without additional button clicks. Just click the Run button once and watch the bars sort themselves. To pause, you can click the Step button at any time. Running can be resumed by clicking the Run button again.

It's not intended that readers study the code for the Workshop applets, which is mostly concerned with the graphic presentation. Hence source listings are not provided.

Example Programs

The example programs are intended to show as simply as possible how the data structures and algorithms discussed in this book can be implemented in Java. These example Appendix A - How to Run the Workshop Applets and Example Programs programs consist of Java *applications* (as opposed to applets). Java applications are not meant to be sent over the Web, but instead run as normal programs on a specific machine.

Java applications can run in either *console mode* or graphics mode. For simplicity, our example programs run in console mode, which means that output is displayed as text and input is performed by the user typing at the keyboard. In the Windows environment the console mode runs in an MS-DOS box. There is no graphics display in console mode.

The source code for the example programs is presented in the text of the book. Source files, consisting of the same text as in the book, are included on the CD-ROM. There are also compiled versions of the example programs. The source code for each program is a single `.java` file, while the compiled code consists of several `.class` files.

Running the Example Programs

You can use the `java` interpreter from the CD-ROM to run the example programs directly from the `.class` files. For each program, one `.class` file ends with the letters `App`, for application. It's this file that must be invoked with `java`.

From an MS-DOS prompt, go to the appropriate subdirectory (using the `cd` command) and find this `App` file. For example, for the `insertSort` program of Chapter 3, go to the `insertSort` subdirectory for Chapter 3. (Don't confuse the directory holding the applets with the directory holding the example programs.) You'll find a `.java` file and several `.class` files. One of these is `insertSortApp.class`. To execute the program, enter

```
C:java insertSortApp
```

Don't type a file extension. The `insertSort` program should run, and you'll see a text display of unsorted and sorted data. In some example programs you'll see a prompt inviting you to enter input, which you type at the keyboard.

Compiling the Example Programs

You can experiment with the example programs by modifying them and then compiling and running the modified versions. You can also write your own applications from scratch, compile them, and run them. To compile a Java application, you use the `javac` program, invoking the example's `.java` file. For example, to compile the `insertSort` program, you would go to the `insertSort` directory and enter

```
C: javac insertSort.java
```

This will compile the `.java` file into as many `.class` files as there are classes in the program. If there are errors in the source code, you'll see them displayed on the screen.

Editing the Source Code

Many text editors are appropriate for modifying the `.java` source files or writing new ones. For example, you can invoke an MS-DOS editor called `edit` from the DOS command line, and Windows includes the Notepad editor (Start/Programs/Accessories/ in Windows 95). Many commercial text editors are available as well. See the `readme.txt` file on the CD-ROM for more information.

Don't use a fancy word processor, such as Microsoft Word, for editing source files. Word processors typically generate output files with strange characters, which the Java interpreter won't understand.

Terminating the Example Programs

You can terminate any running console-mode program, including any of the example programs, by pressing the **CTRL-c** key combination (the control key and the C key pressed at the same time). Some example programs have a termination procedure that's mentioned in the text, such as pressing Enter at the beginning of a line, but for the others you must press **CTRL-c**.

Multiple Class Files

Often several Workshop applets, or several example programs, will use `.class` files with the same names. Note, however, that these files may not be identical. The applet or example program may not work if the wrong class file is used with it, even if the file has the correct name.

This should not normally be a problem, because all the files for a given program are placed in the same subdirectory. However, if you move files by hand you may inadvertently copy a file to the wrong directory. Doing this may cause problems that are hard to trace.

Other Development Systems

There are many other Java development systems besides Sun's JDK. Products are available from Symantec, Microsoft, Borland, Asymetrix, and so on. These products are generally faster and more convenient to use than the JDK. They typically combine all functions—editing, compiling, and execution—in a single window.

For use with the example programs in this book, such development systems should be able to handle Java 1.1.4 or later. Many example programs (specifically, those that include user input) cannot be compiled with products designed for earlier versions of Java.

Appendix B: Further Reading

Overview

In this appendix we'll mention some books on various aspects of software development, including data structures and algorithms. This is a subjective list; there are many other excellent titles on all the topics mentioned.

Data Structures and Algorithms

The definitive reference for any study of data structures and algorithms is *The Art of Computer Programming* by Donald E. Knuth, of Stanford University (Addison Wesley, 1997). This seminal work, originally published in the 1970s, is now in its third edition. It consists of three volumes: *Volume 1: Fundamental Algorithms*, *Volume 2: Seminumerical Algorithms*, and *Volume 3: Sorting and Searching*. Of these, the last is the most relevant to the topics in this book. This work is highly mathematical and does not make for easy reading, but it is the bible for anyone contemplating serious research in the field.

A somewhat more accessible text is Robert Sedgewick's *Algorithms in C++* (Addison Wesley, 1992). This book is adapted from the earlier *Algorithms* (Addison Wesley, 1988) in which the code examples were written in Pascal. It is comprehensive and authoritative. The text and code examples are quite compact and require close reading.

A good text for an undergraduate course in data structures and algorithms is *Data Abstraction and Problem Solving with C++: Walls and Mirrors* by Frank M. Carrano (Benjamin Cummings, 1995). There are many illustrations, and the chapters end with exercises and projects.

Appendix B - Further Reading *Practical Algorithms in C++*, by Bryan Flamig (John Wiley and Sons, 1995), covers many of the usual topics in addition to some topics not frequently covered by other books, such as algorithm generators and string searching.

Some other worthwhile texts on data structures and algorithms are *Classic Data Structures in C++* by Timothy A. Budd (Addison Wesley, 1994); *Algorithms, Data Structures, and Problem Solving with C++* by Mark Allen Weiss (Addison Wesley, 1996); and *Data Structures Using C and C++* by Y. Langsam, et al. (Prentice Hall, 1996).

Object-Oriented Programming Languages

For an accessible and thorough introduction to Java and object-oriented programming, try *Object-Oriented Programming in Java*, by Stephen Gilbert and Bill McCarty (Waite Group Press, 1997).

If you're interested in C++, try *Object-Oriented Programming in C++* by Robert Lafore (Waite Group Press, 1995).

The Java Programming Language by Ken Arnold and James Gosling (Addison Wesley, 1996) deals with Java syntax and is certainly authoritative (although briefer than many books): Gosling, who works at Sun Microsystems, is the creator of Java.

Java How to Program by H. M. Deitel and P. J. Deitel (Prentice Hall, 1997) is a good Java text book, complete with many exercises.

Core Java by Cay S. Horstmann and Gary Cornell (Prentice Hall, 1997) is a multivolume series that covers in depth such advanced Java topics such as the AWT, debugging, and the Java event model.

Object-Oriented Design (OOD) and Software Engineering

For an easy, non-academic introduction to software engineering, try *The Object Primer: The Application Developer's Guide to Object-Oriented Design* by Scott W. Ambler (Sigs Books, 1995). This short book explains in plain language how to design a large software application. The title is a bit of misnomer; it goes way beyond mere OO concepts.

To be published in 1998 is *Object-Oriented Design in Java* by Stephen Gilbert and Bill McCarty (Waite Group Press). This is an unusually accessible text.

A classic in the field of OOD is *Object-Oriented Analysis and Design with Applications* by Grady Booch (Addison Wesley, 1994). The author is one of the pioneers in this field and the creator of the Booch notation for depicting class relationships. This book isn't easy for beginners, but is essential for more advanced readers.

An early book on OOD is *The Mythical Man-Month* by Frederick P. Brooks, Jr. (Addison Wesley, 1975, reprinted in 1995), which explains in a very clear and literate Data Structures and Algorithms in Java why some of the reasons why good software design is necessary. It is said to have sold more copies than any other computer book.

Other good texts on OOD are *An Introduction to Object-Oriented Programming*, by Timothy Budd (Addison Wesley, 1996); *Object-Oriented Design Heuristics*, by Arthur J. Riel, (Addison Wesley, 1996); and *Design Patterns: Elements of Reusable Object-Oriented Software*, by Erich Gamma, et al. (Addison Wesley, 1995).

Programming Style

Books on other aspects of good programming:

Programming Pearls by Jon Bentley (Addison Wesley, 1986) was written before OOP but is nevertheless stuffed full of great advice for the programmer. Much of the material deals with data structures and algorithms.

Writing Solid Code, by Steve Maguire (Microsoft Press, 1993) and *Code Complete* by Steve McConnell (Microsoft Press, 1993) contain good ideas for software development and coding and will help you develop good programming practices.